

Stuen 78

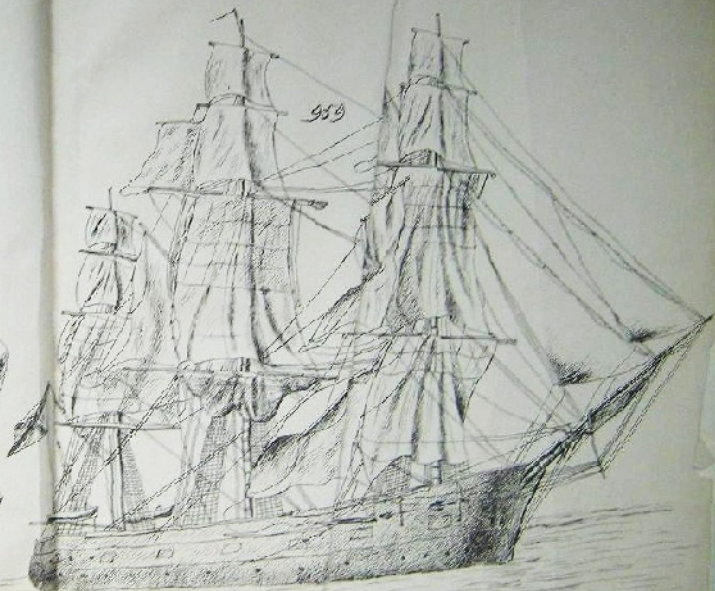

958



959

Stuen 78

рисунок 2.

Автомат.



рисунок 1.



рисунок 4.

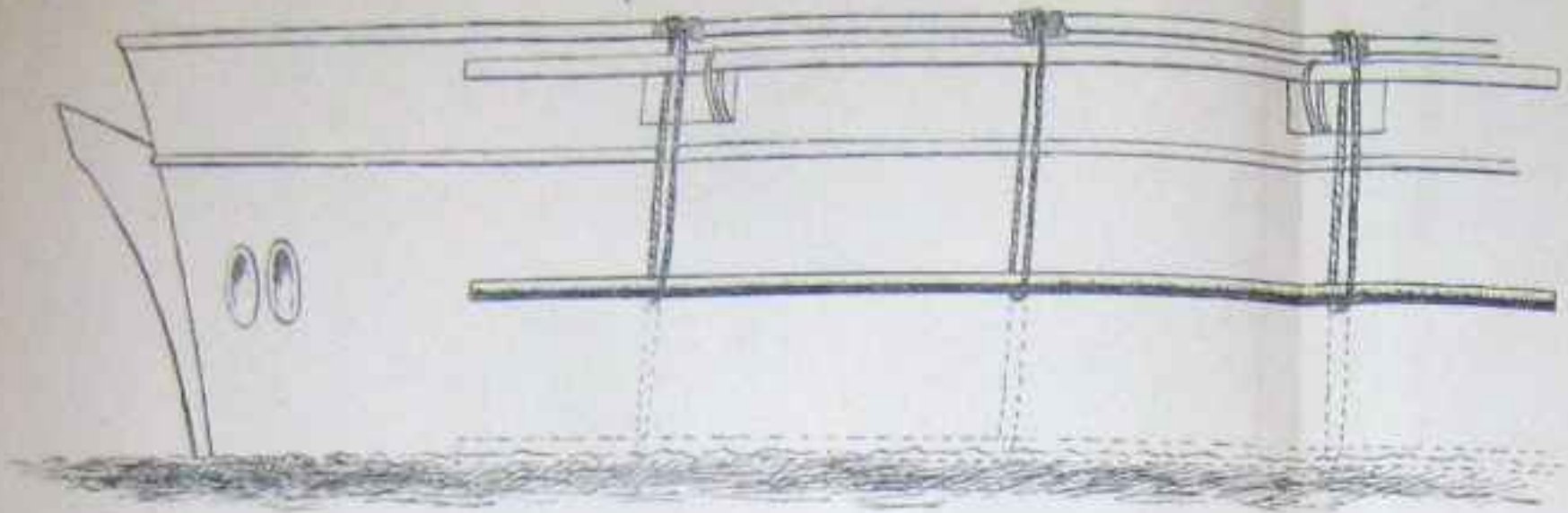

рисунок 3.

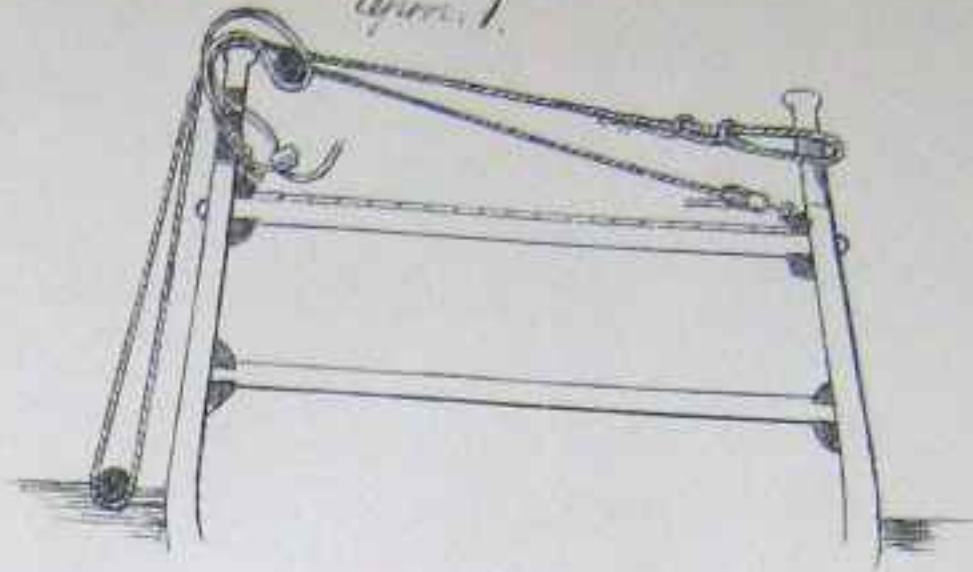

рисунок 5.

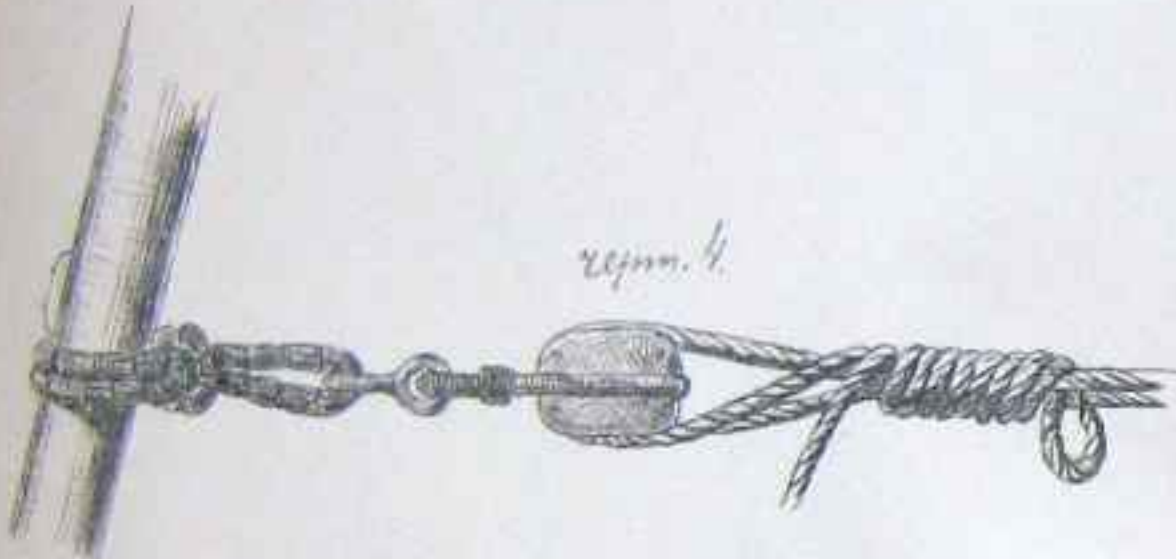

Канаты на корабле

Лучина 2.

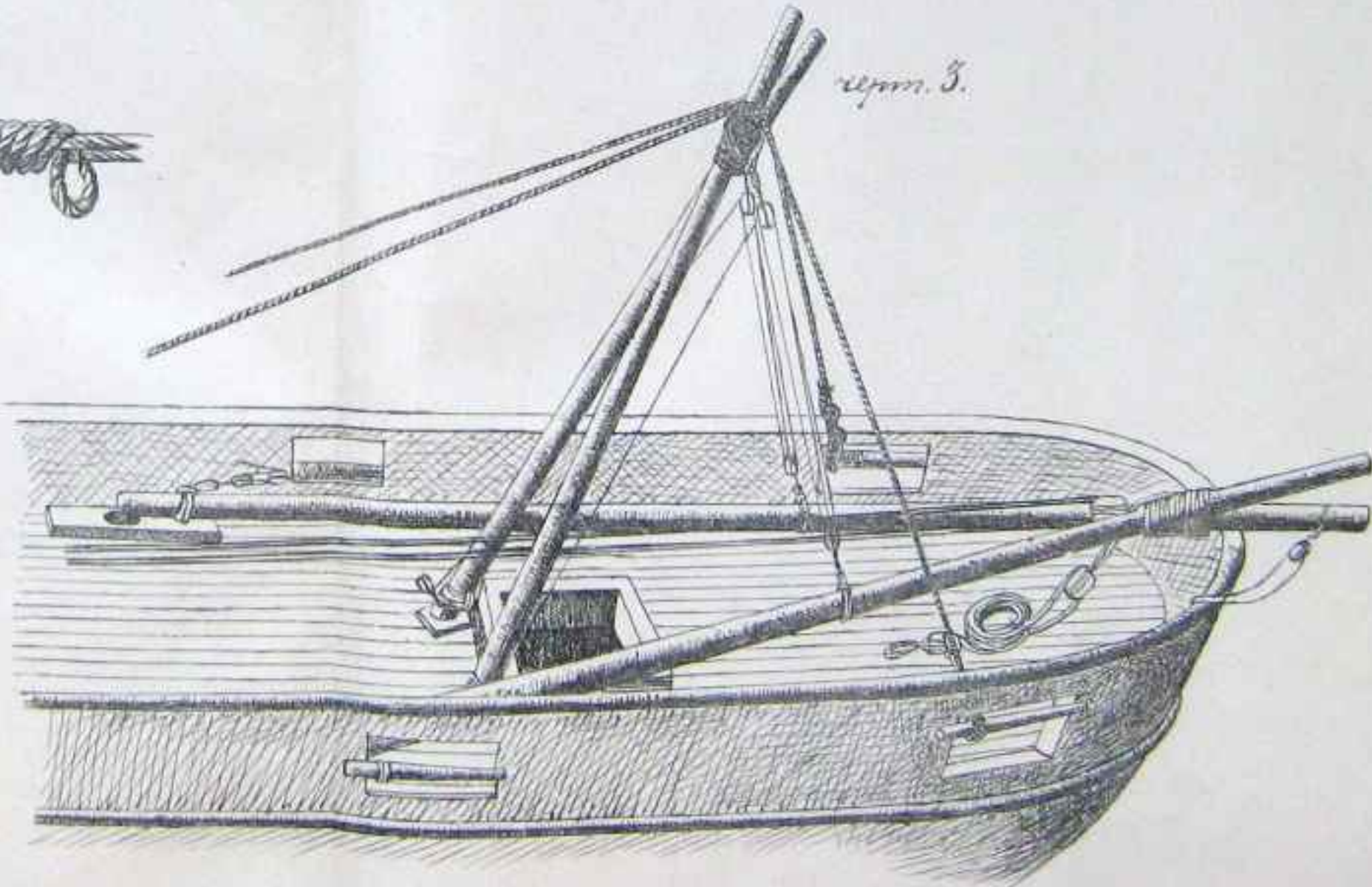
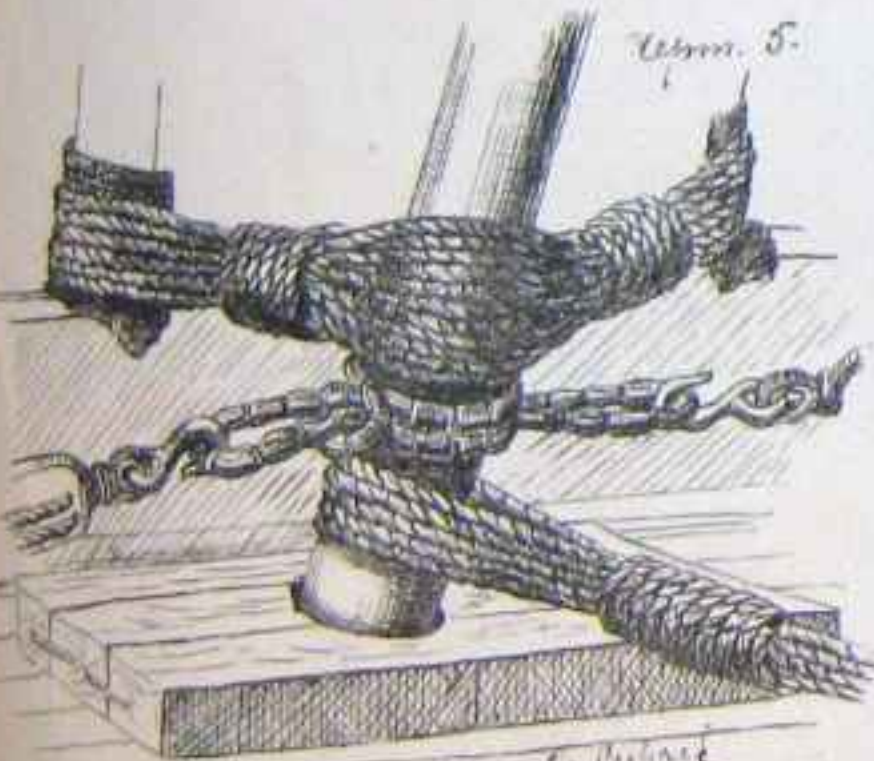
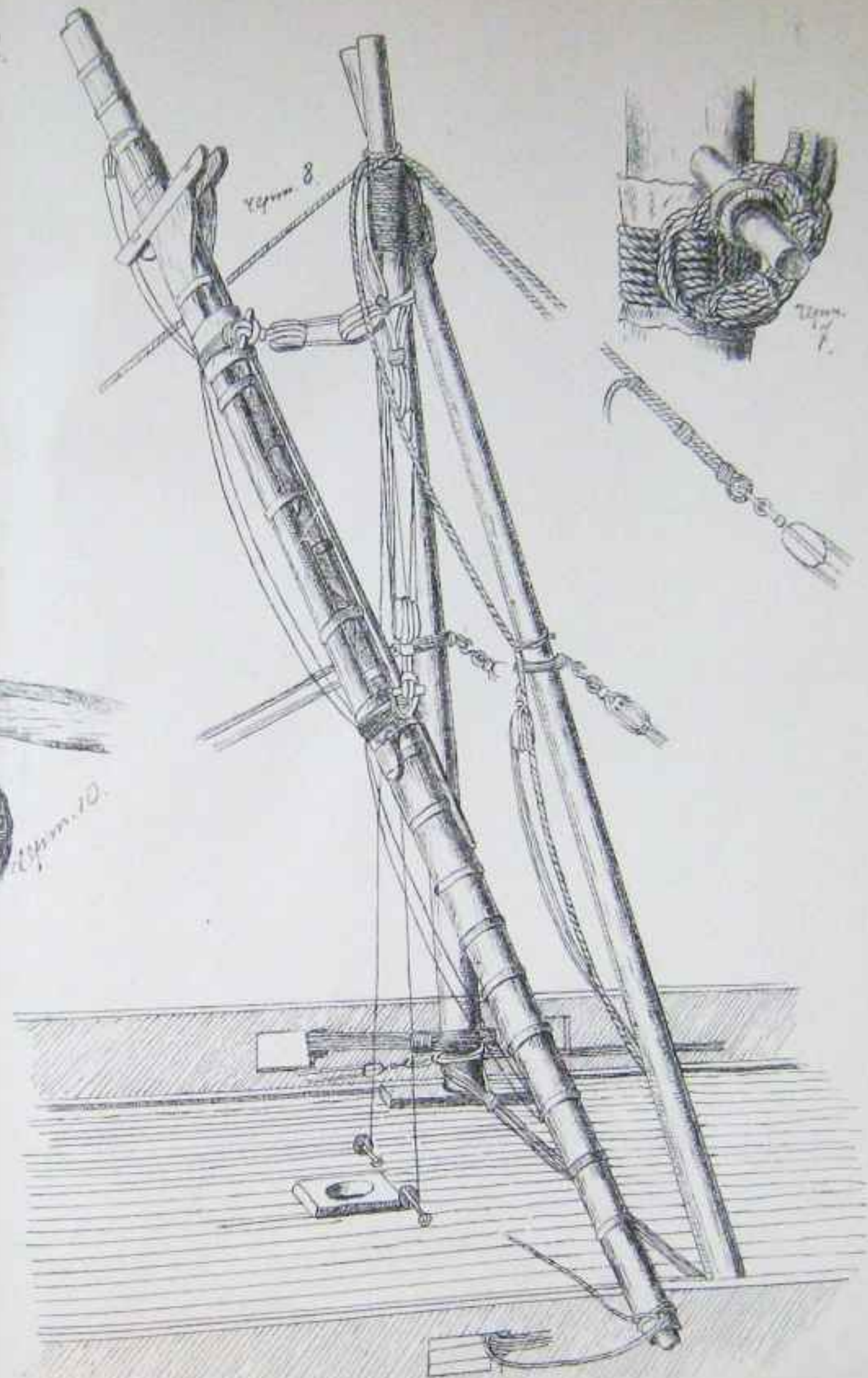
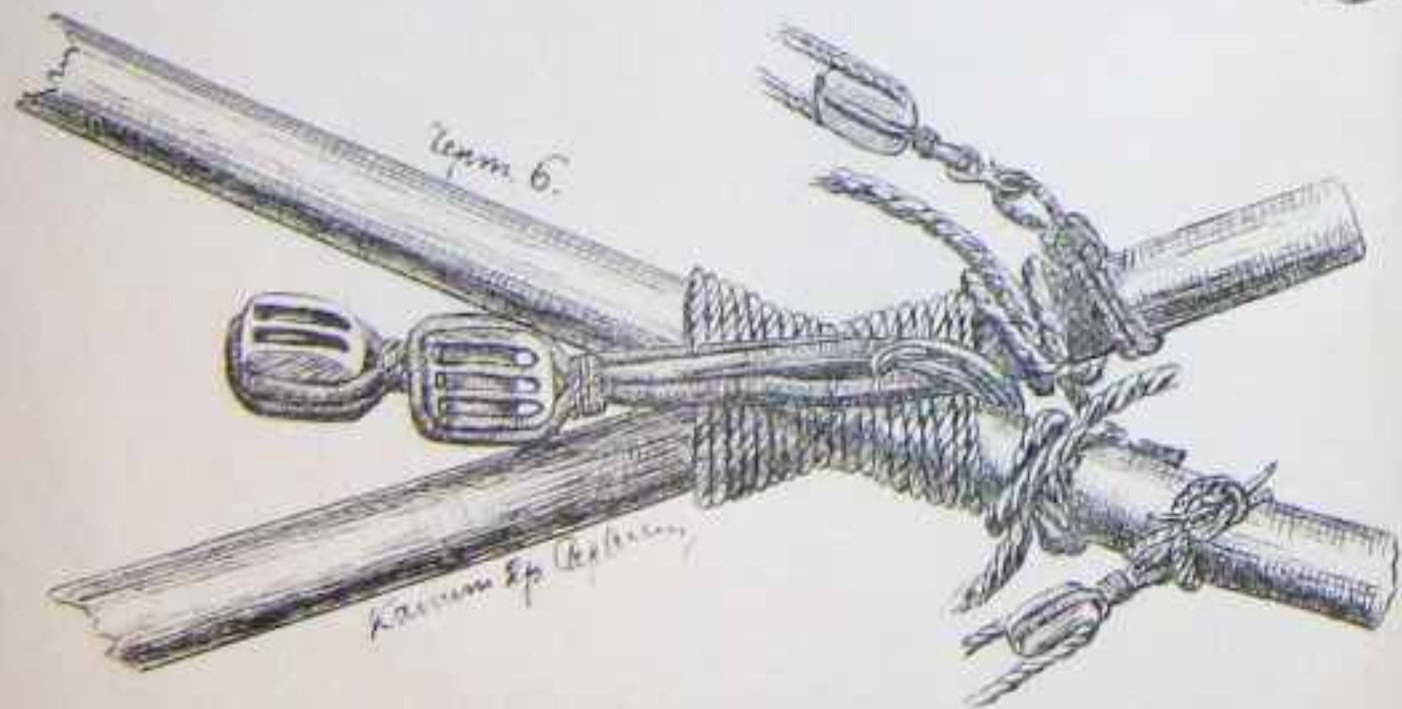
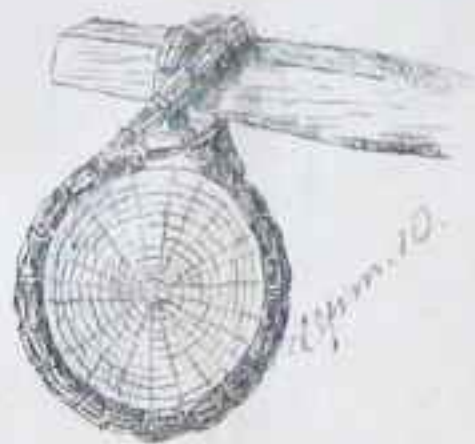
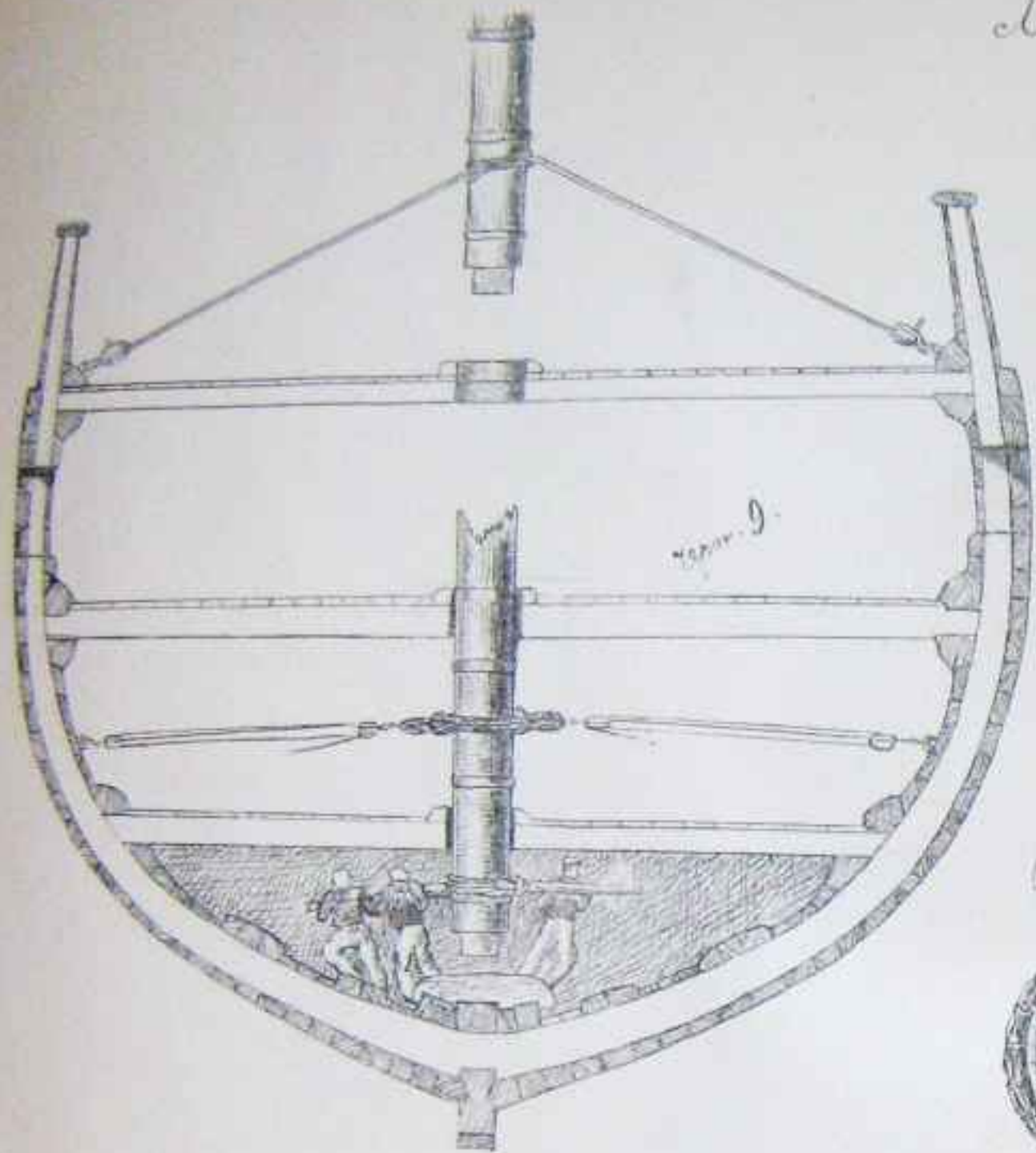

Pluc. 3.

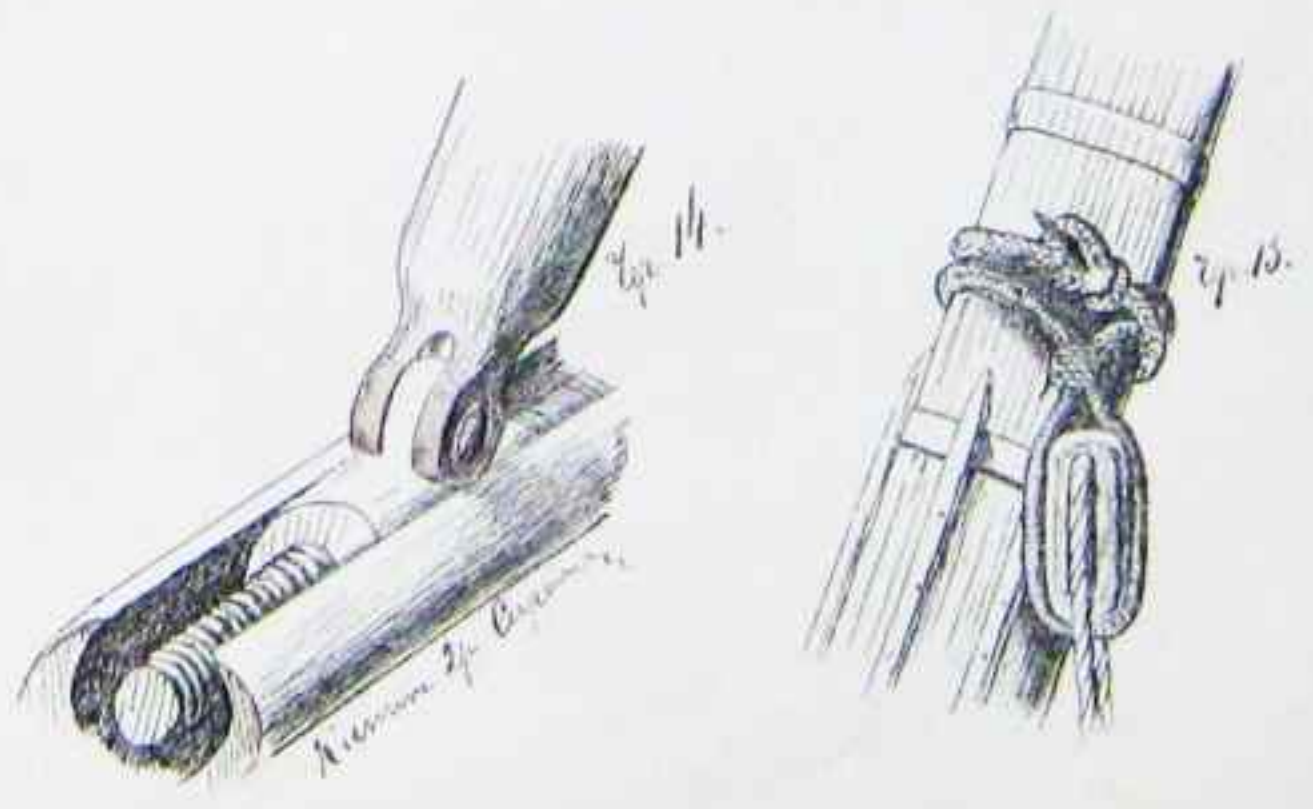
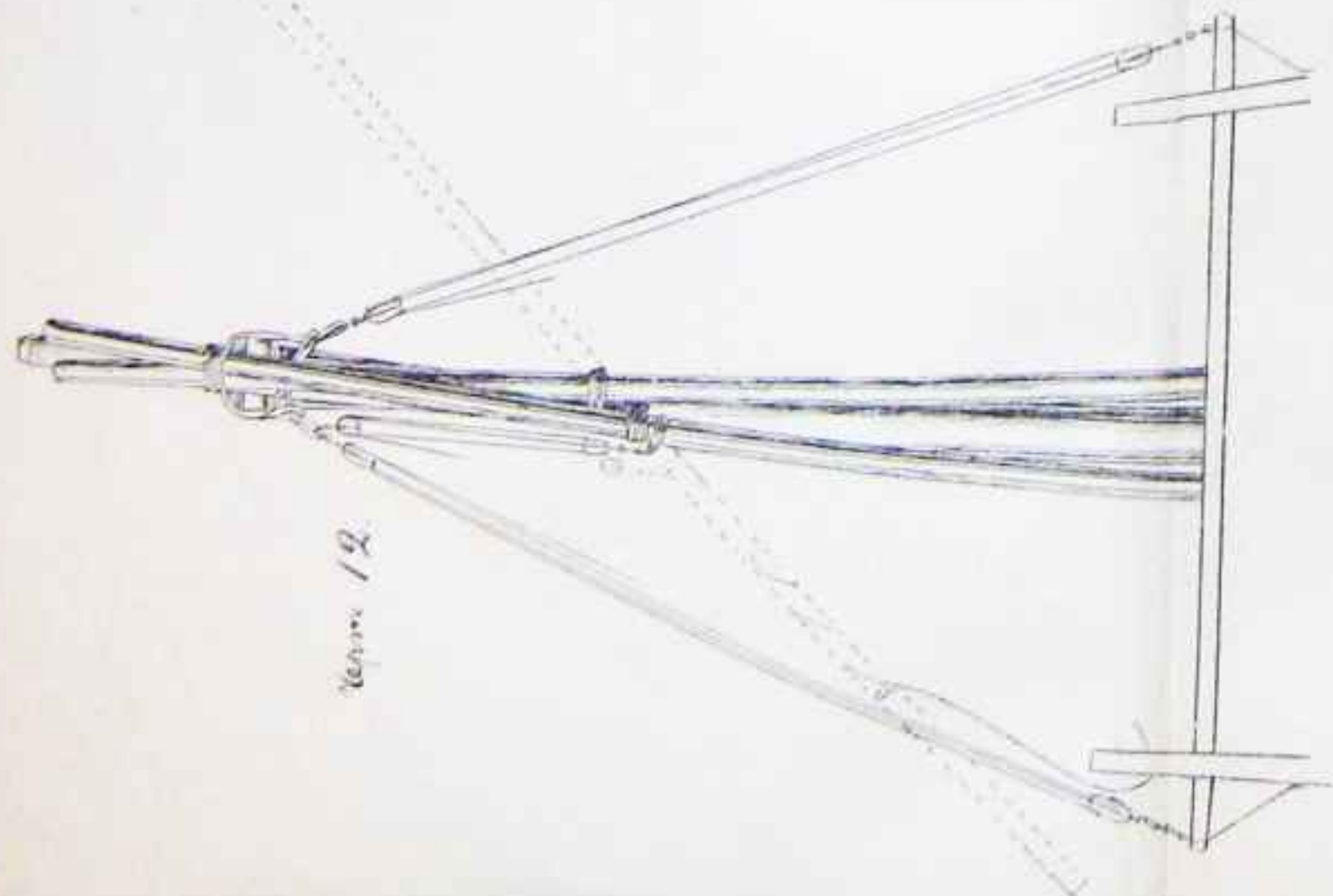
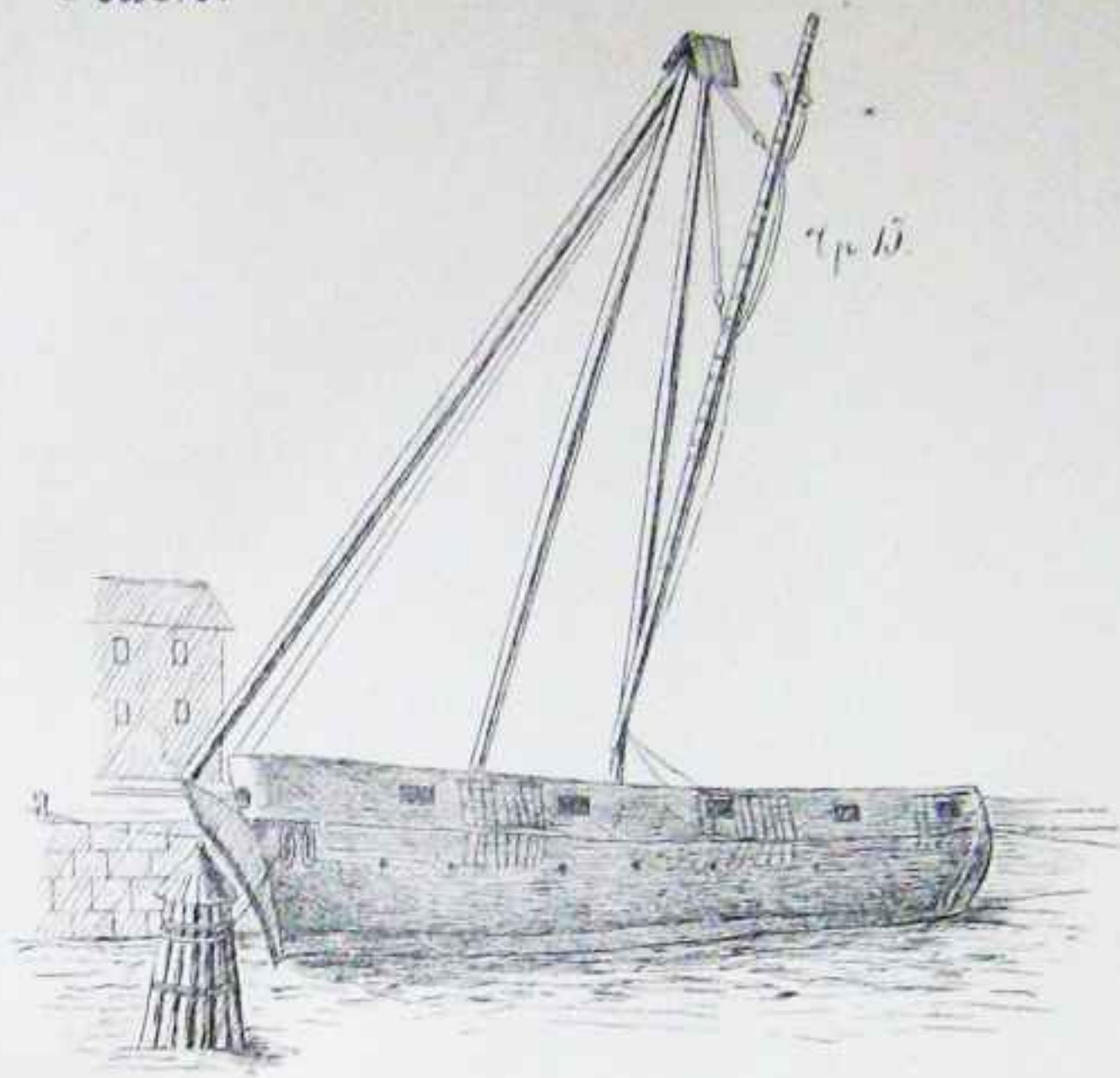
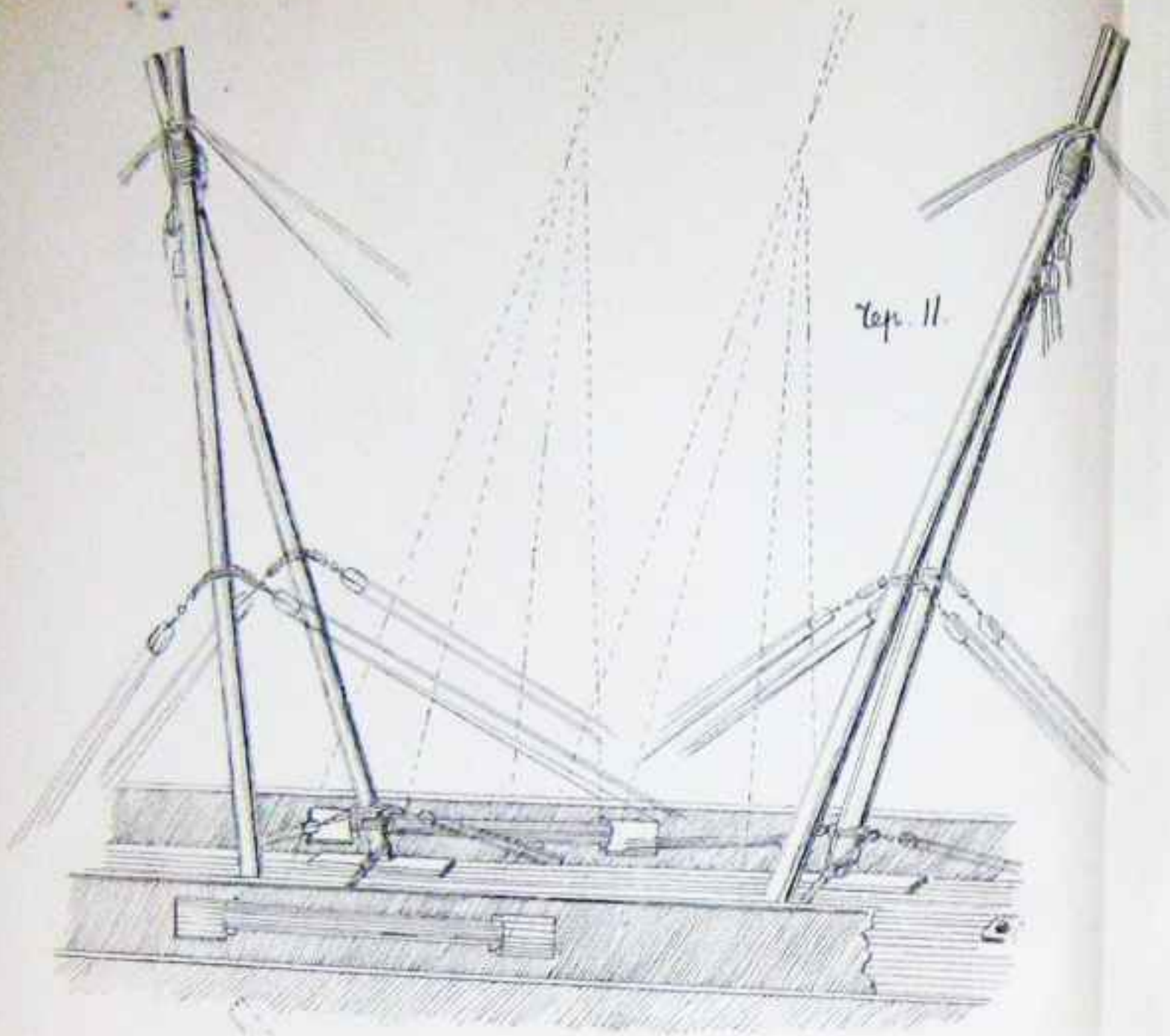

Machine of Crane

Lucien 4.

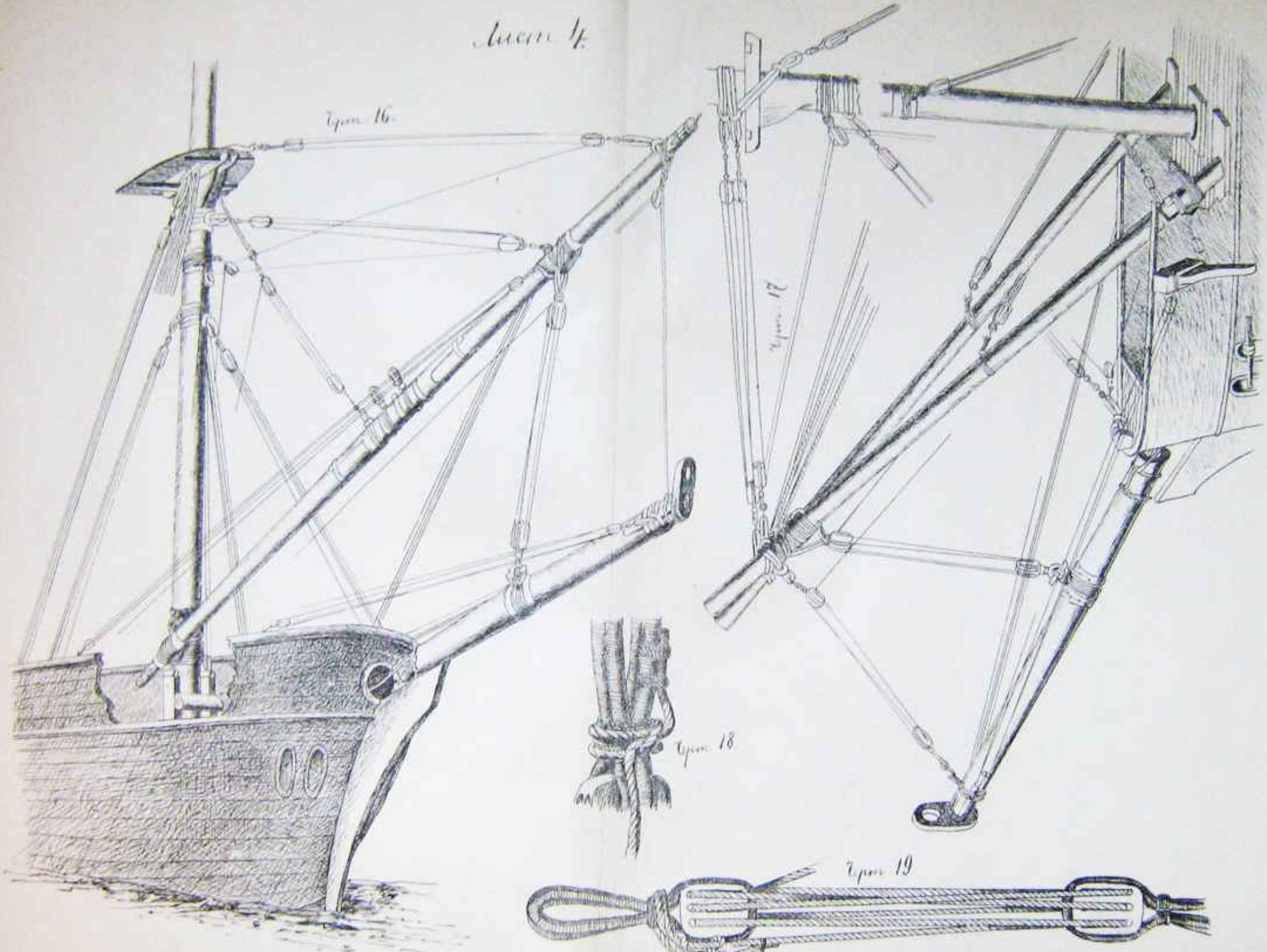

Eplan 16.

Eplan 17.

Eplan 18.

Eplan 19.

Remarque sur l'usage

Aug. 5.

rep. 20



rep. 21.

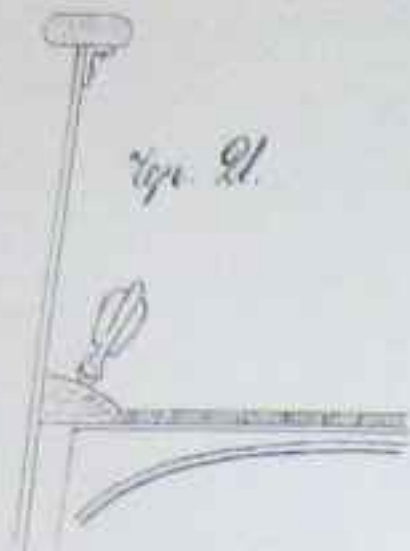

rep. 22.

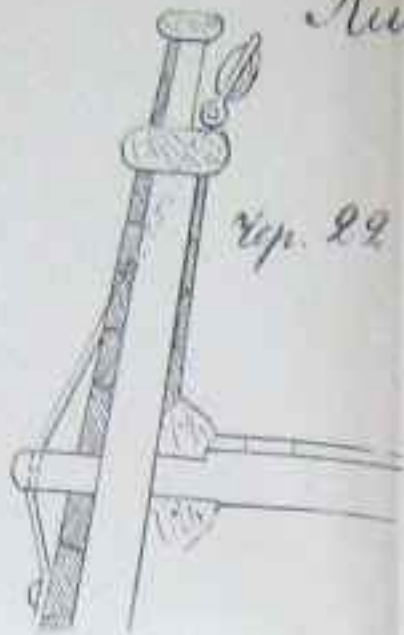

rep. 23.

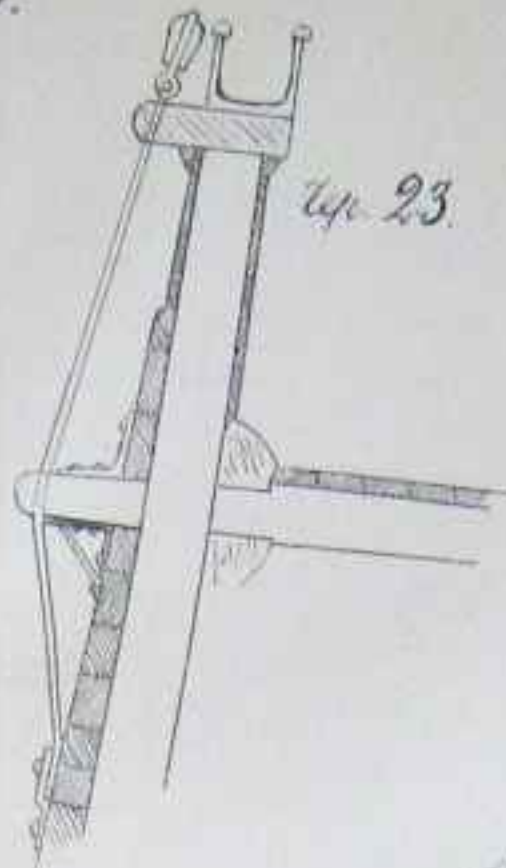

rep. 24.

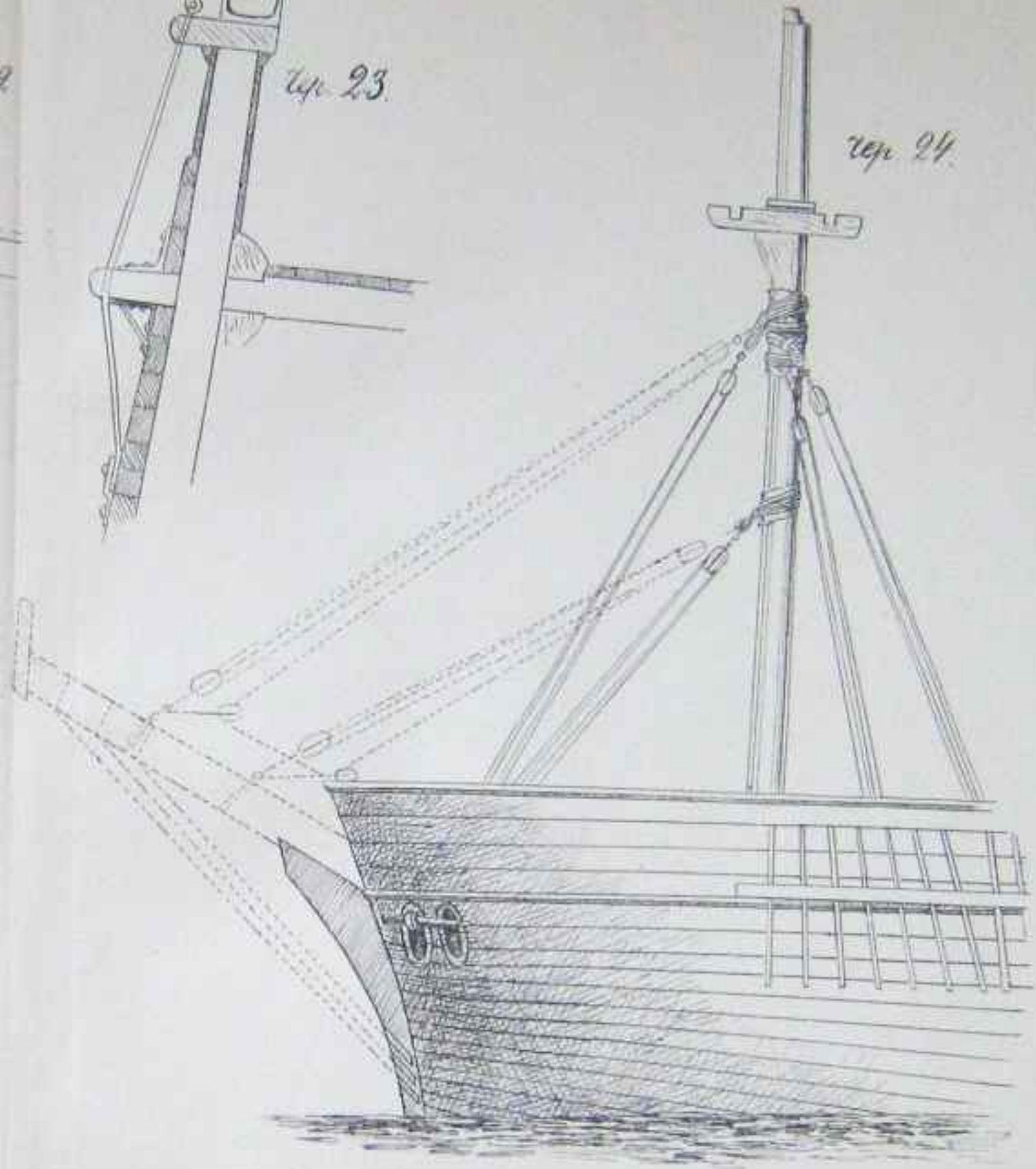

rep. 25.

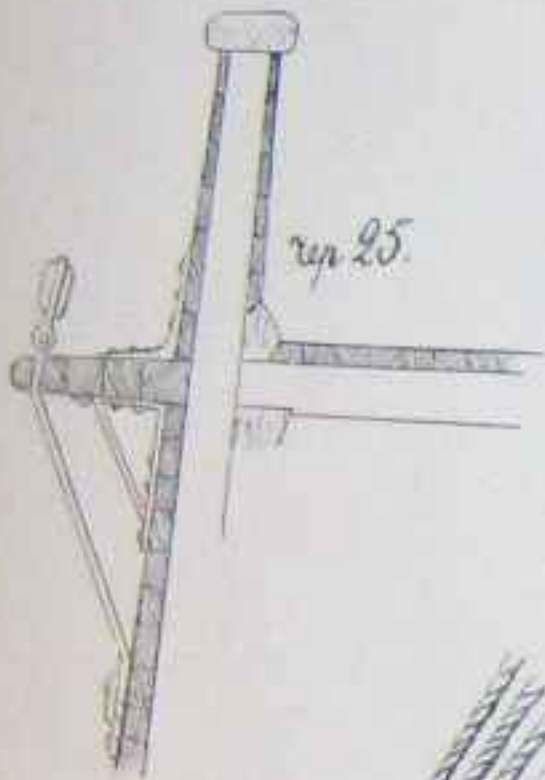

rep. 26.

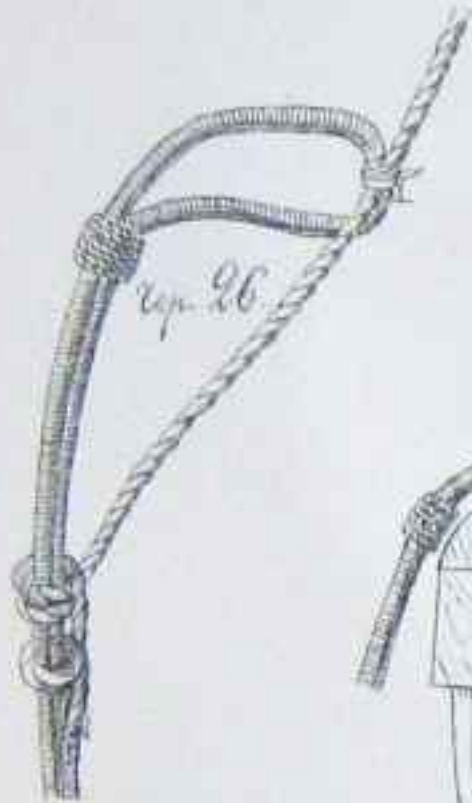

rep. 27.

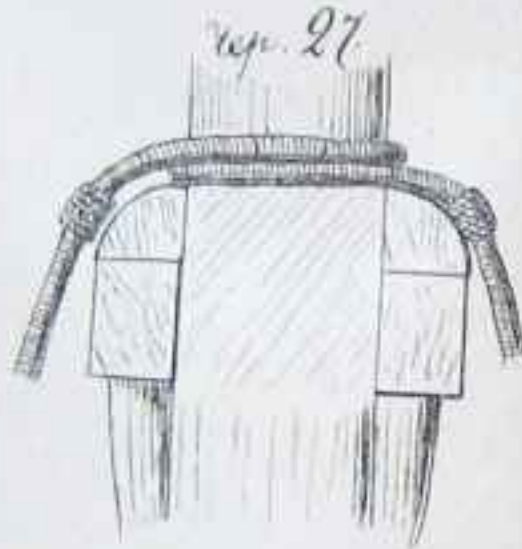

rep. 28.



rep. 29.



Handwritten note: *Handwritten note: 2/3*

rep. 30.



rep. 31.

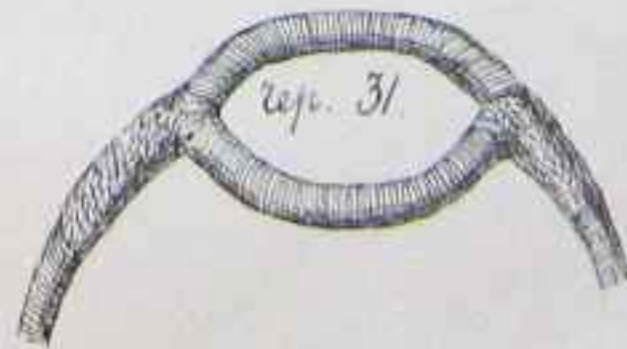

rep. 32.



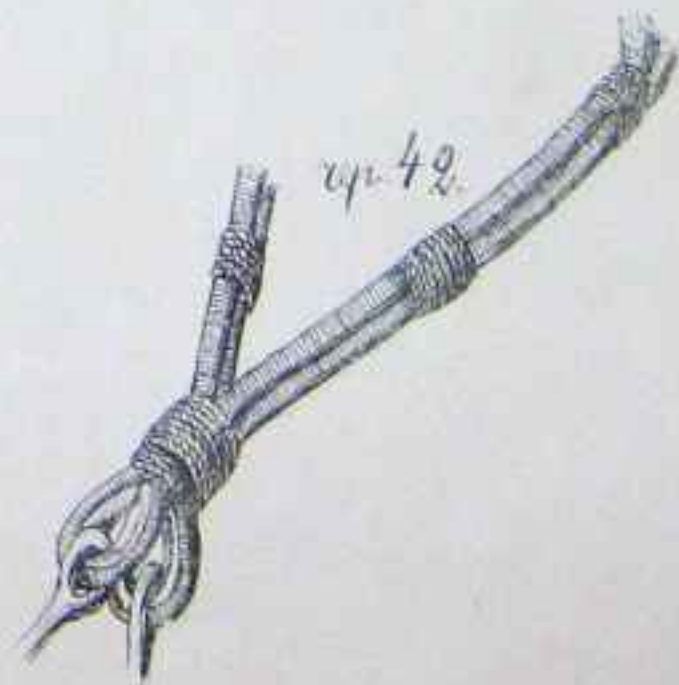
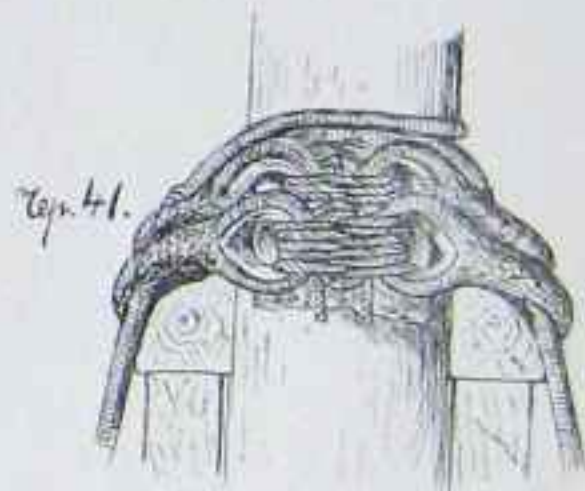
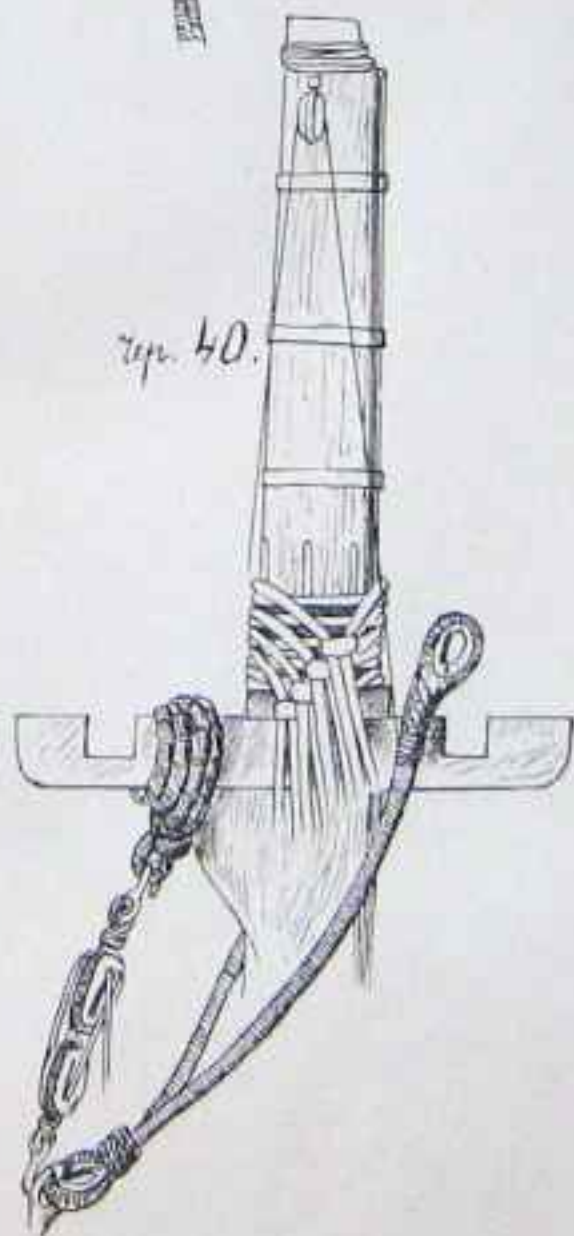
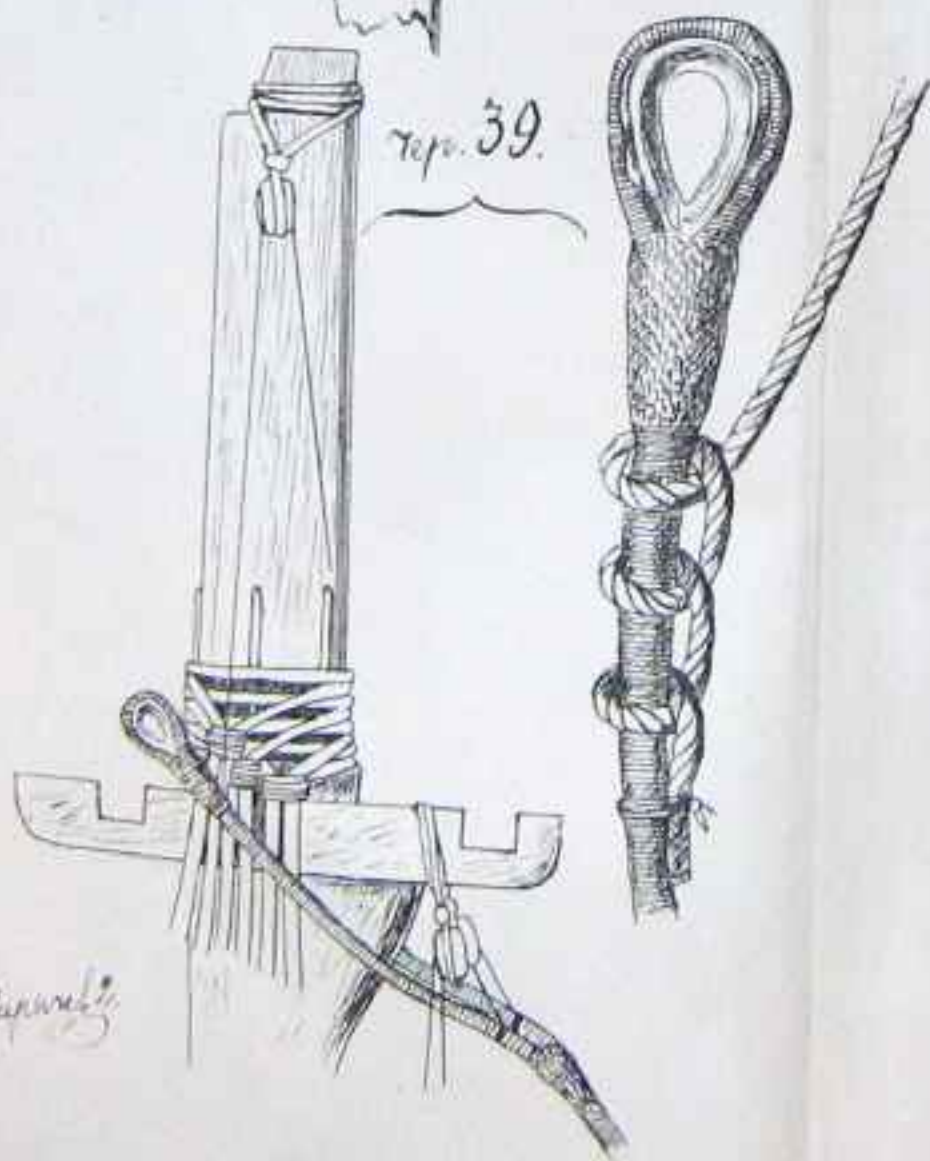
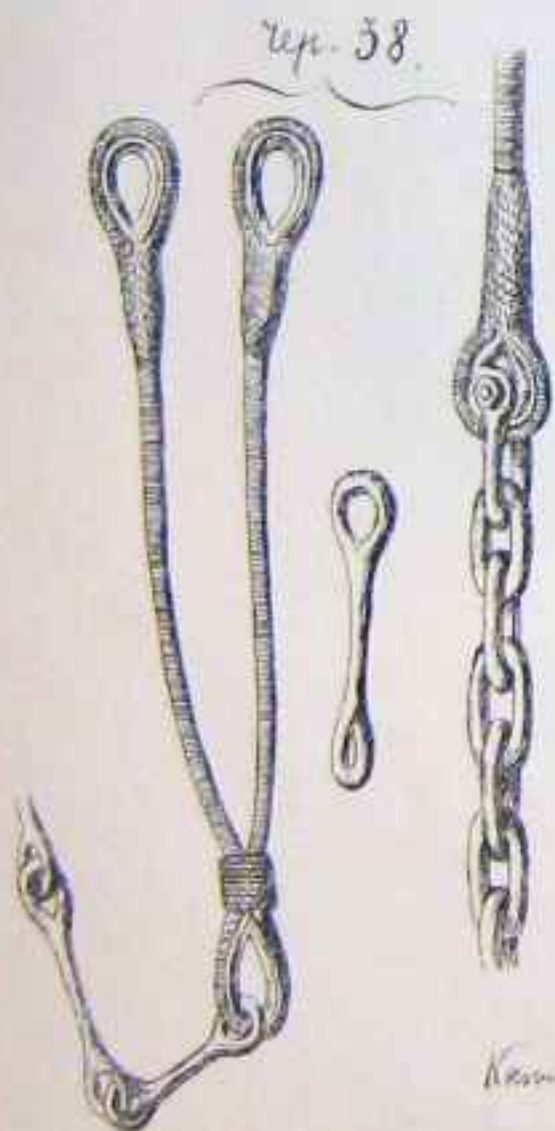
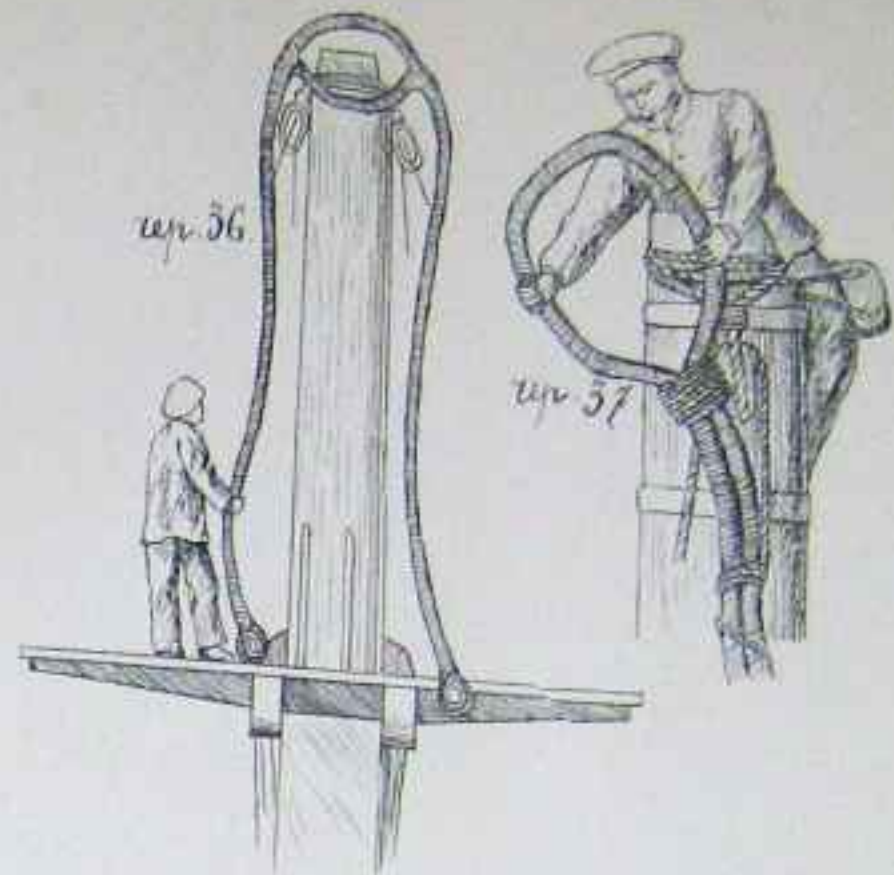
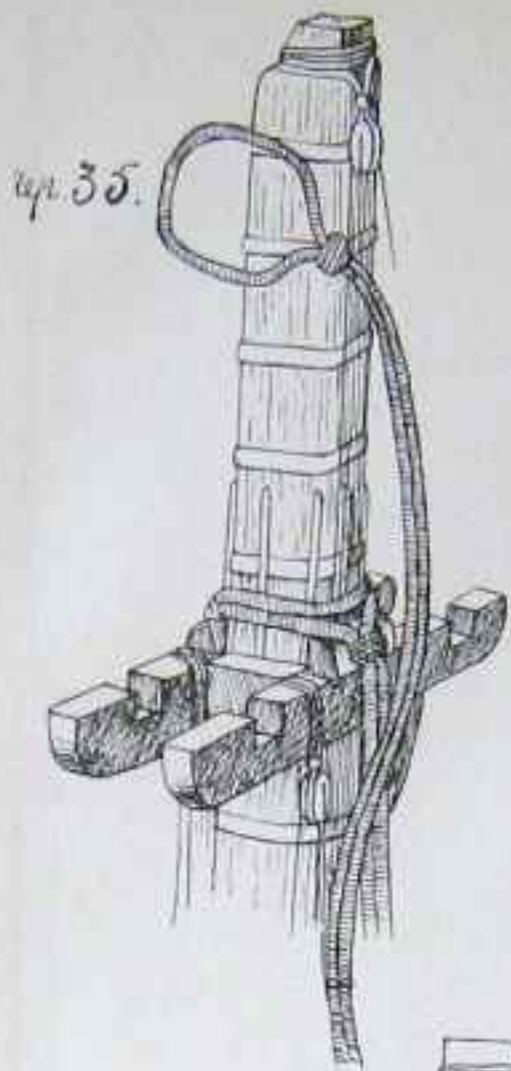
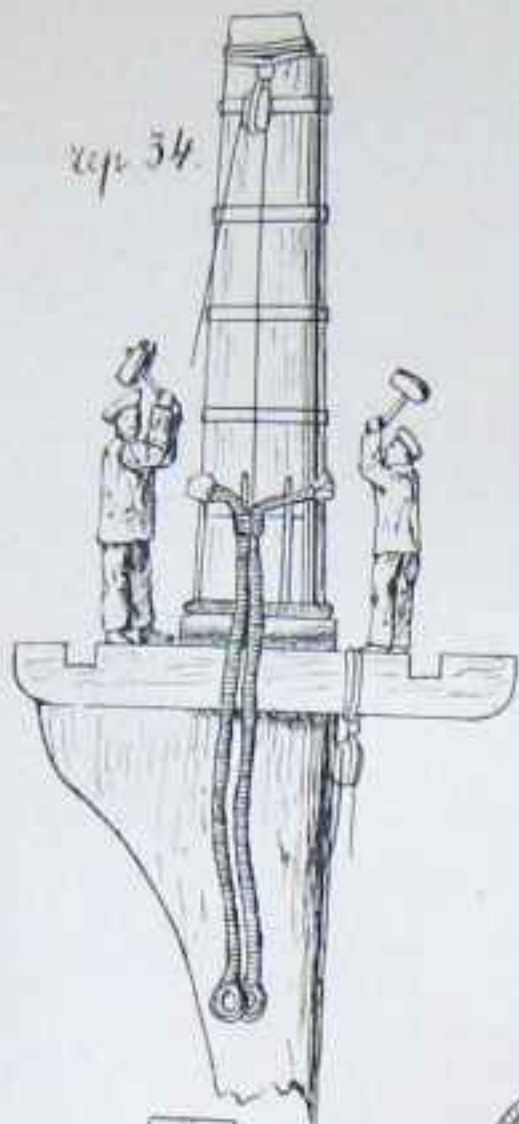
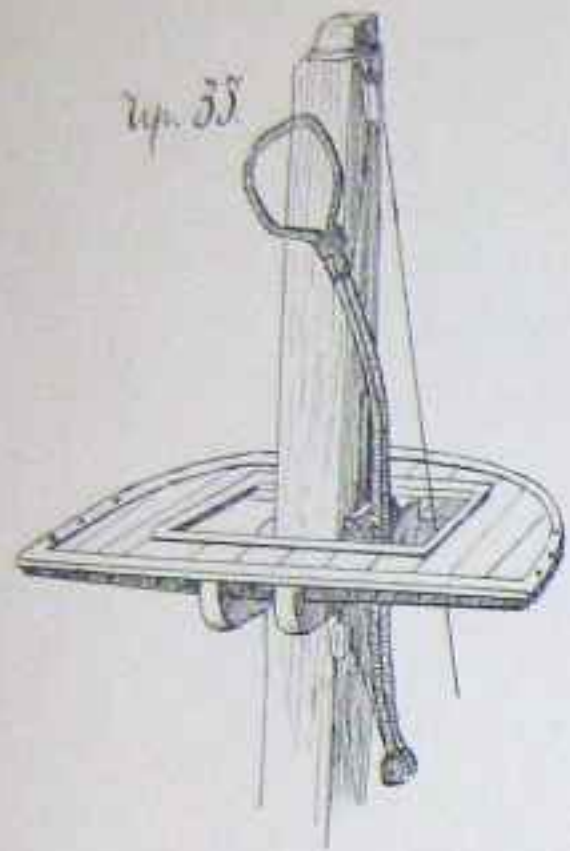

Космонавты Лавренко

Лучма 7.

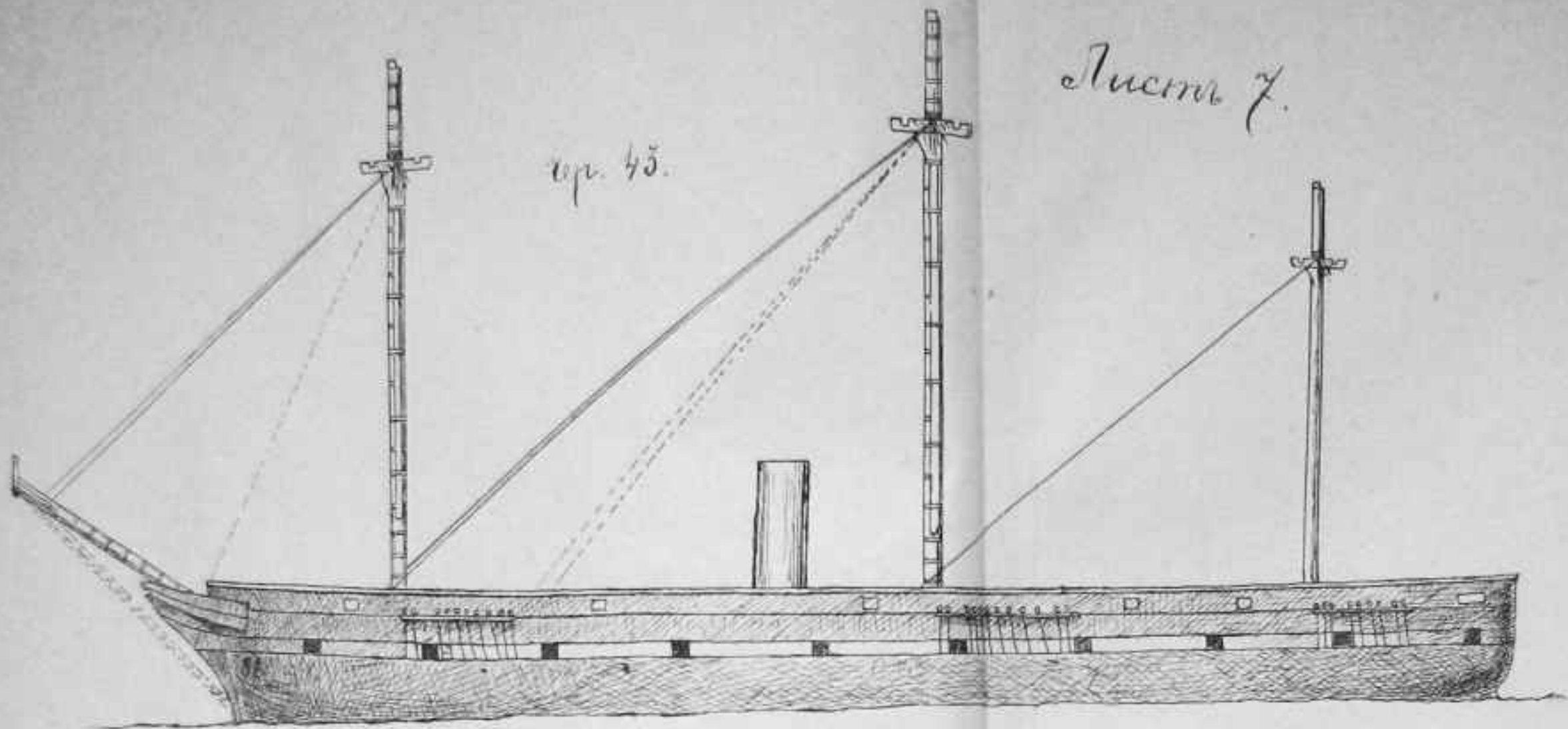

тип 43.



тип 49.

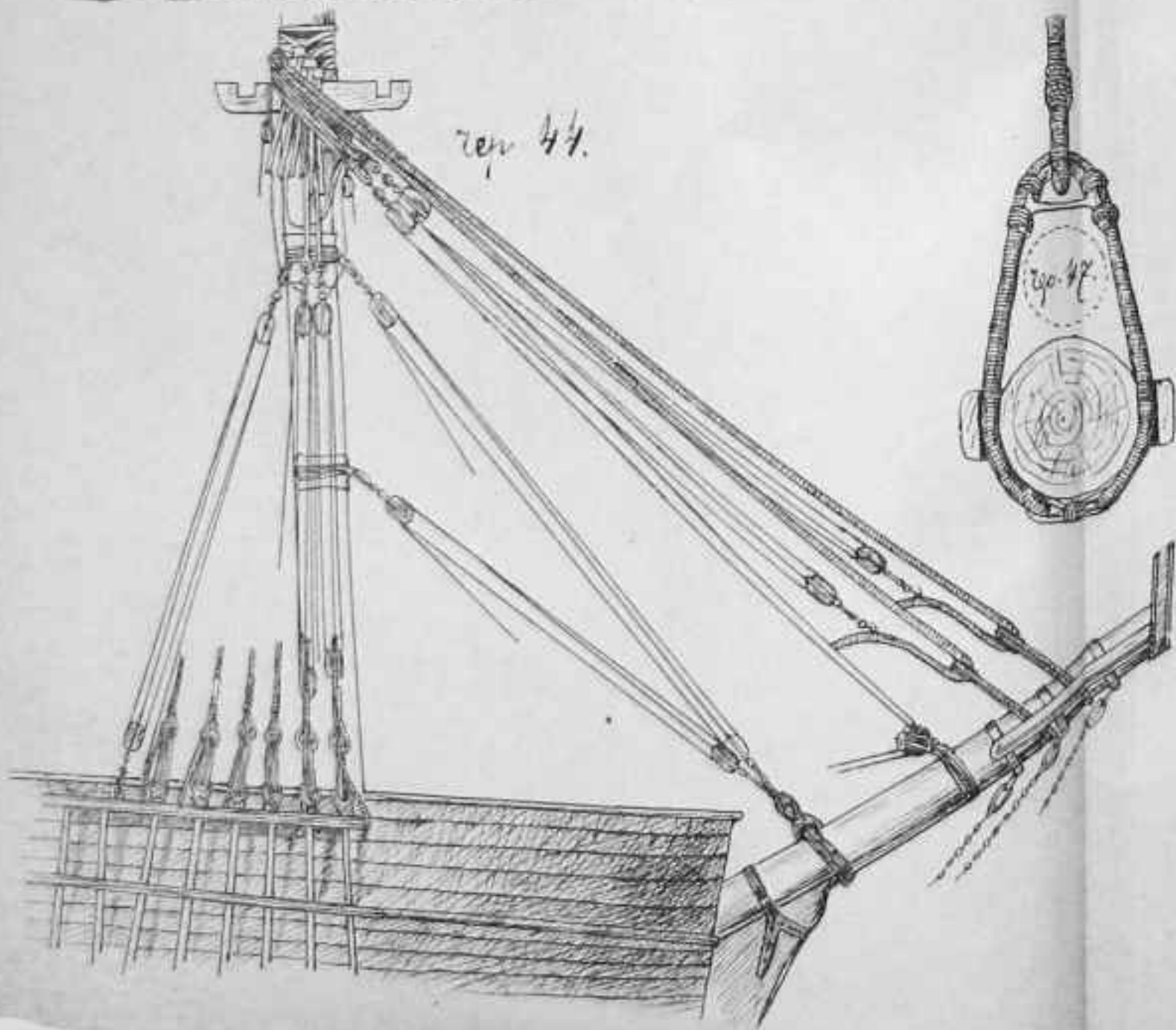

тип 44.

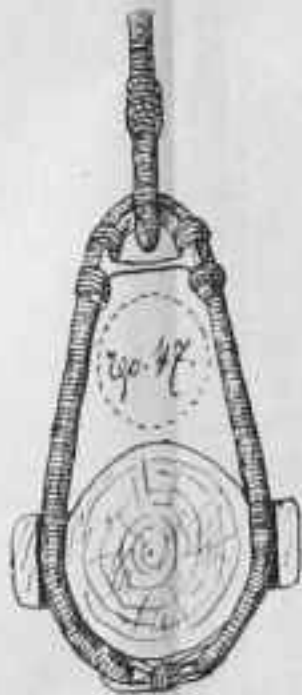

тип 47.

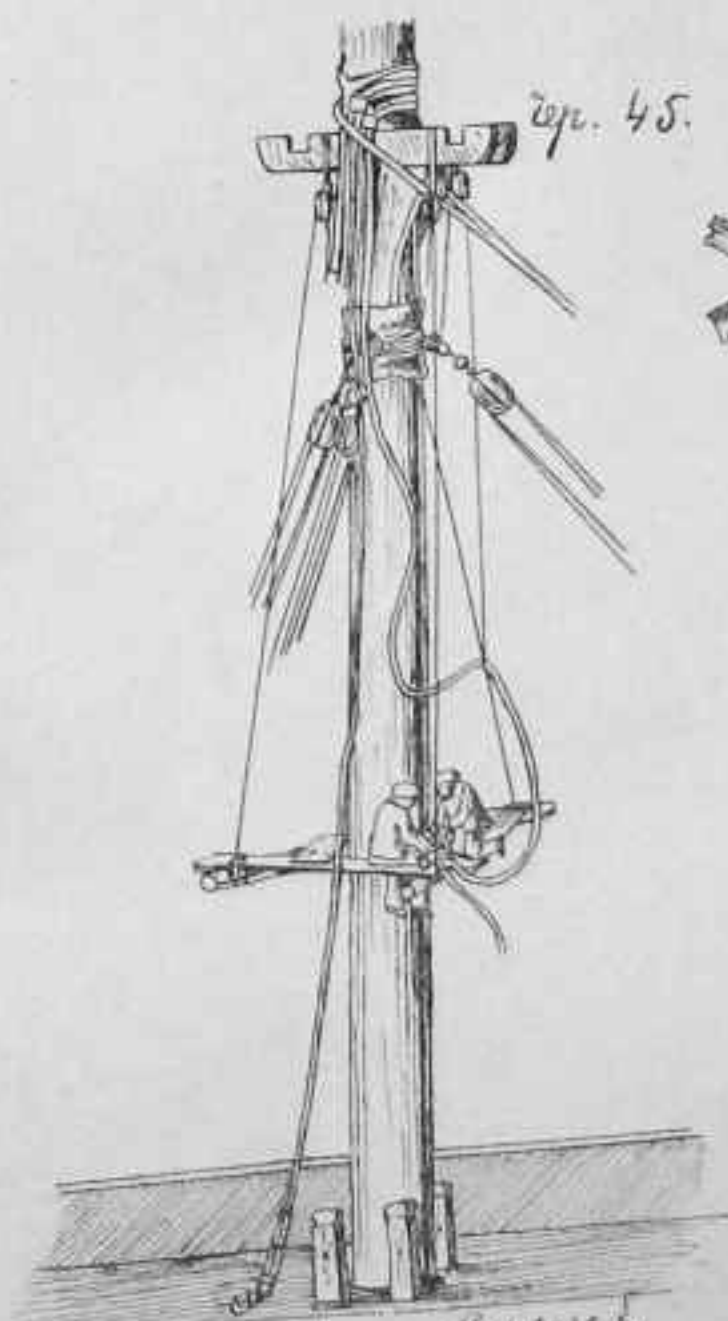

тип 45.

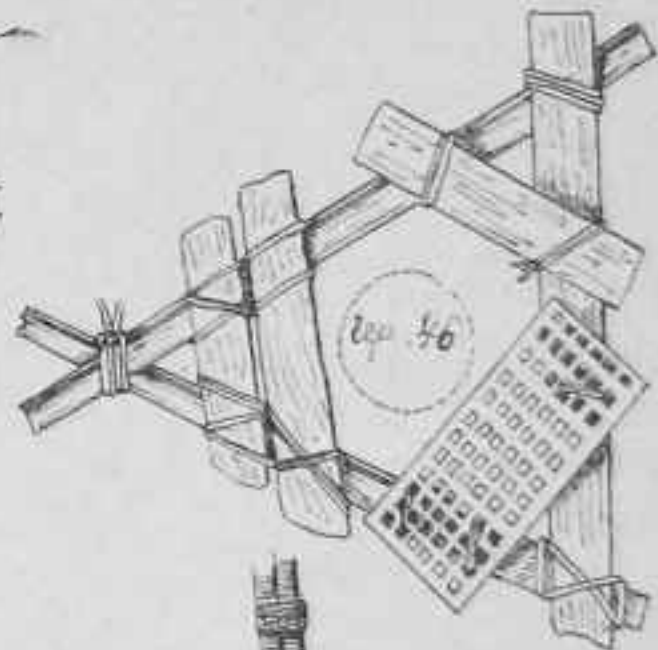

тип 46.

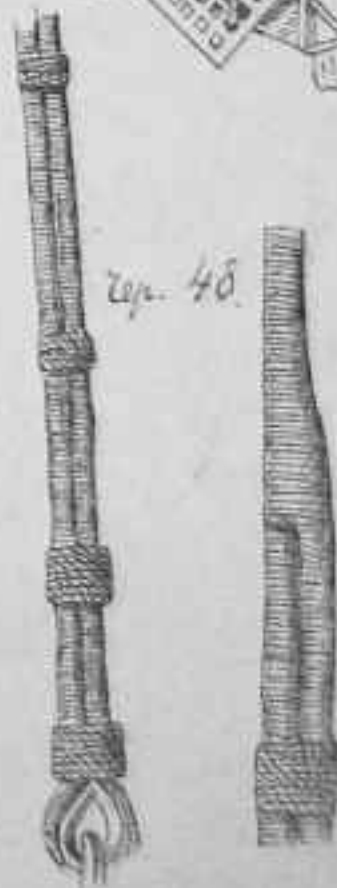

тип 48.

Намун Лхам Сурдере 3

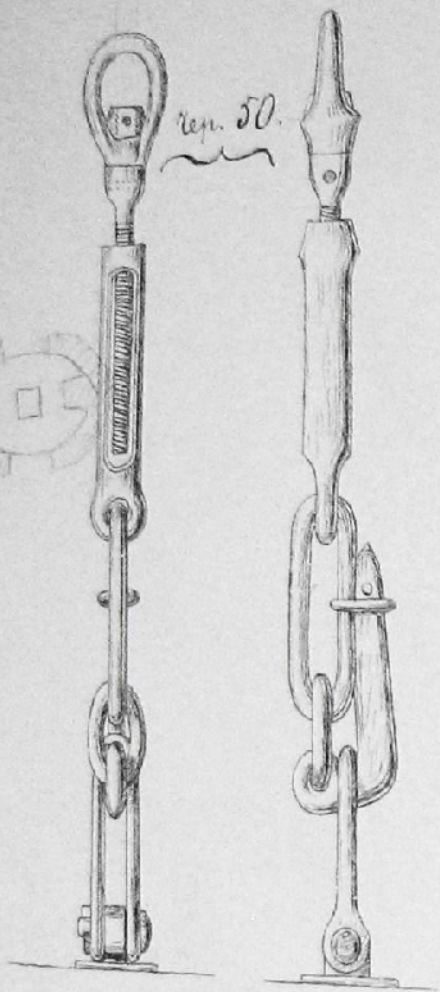

Fig. 50.

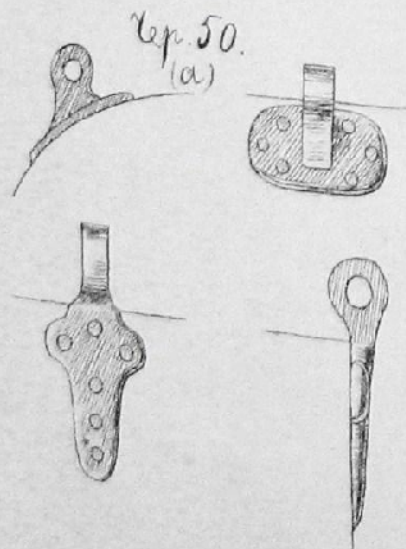

Fig. 50.
(a)



Fig. 52.

Fig. 53.

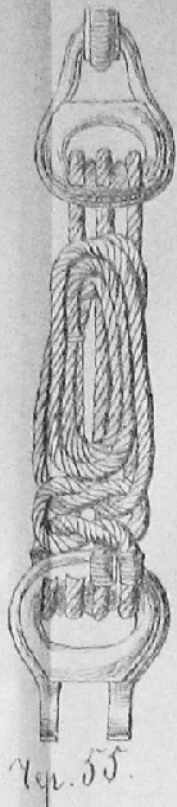

Fig. 55.

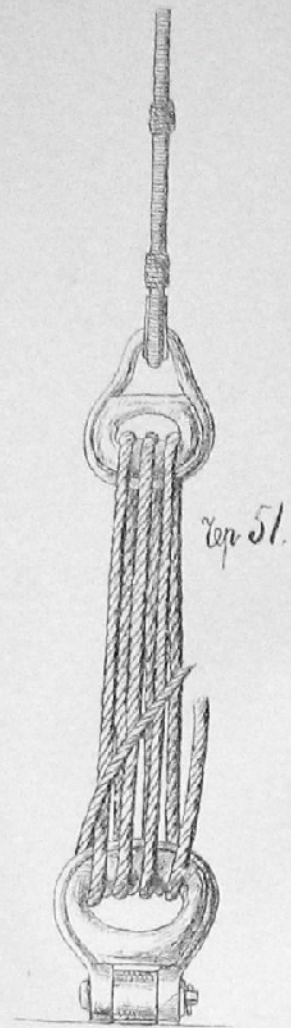

Fig. 51.

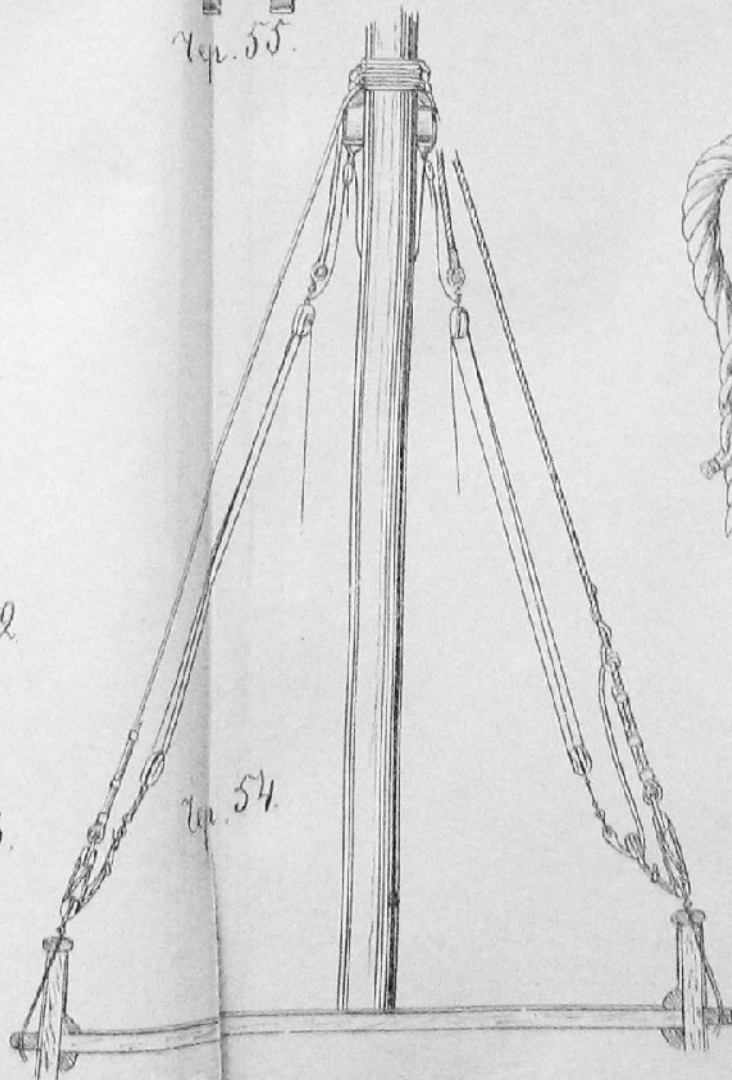

Fig. 54.

Figure 8.

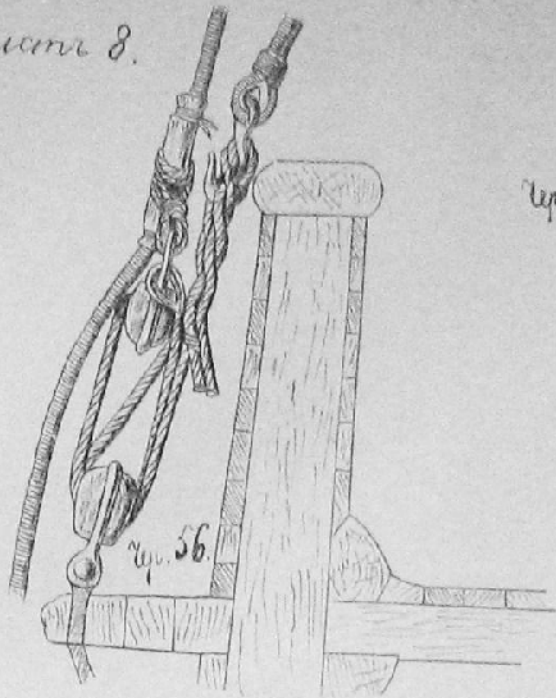

Fig. 56.

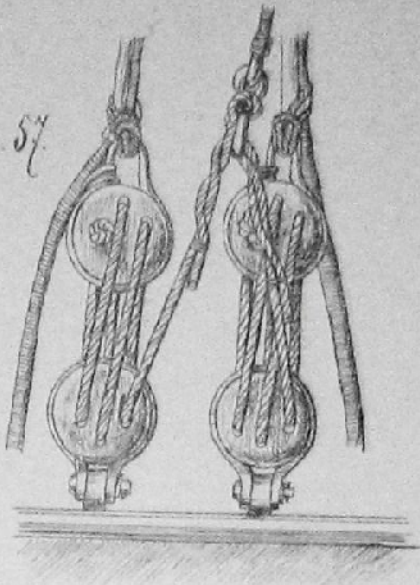

Fig. 57.



Fig. 58.

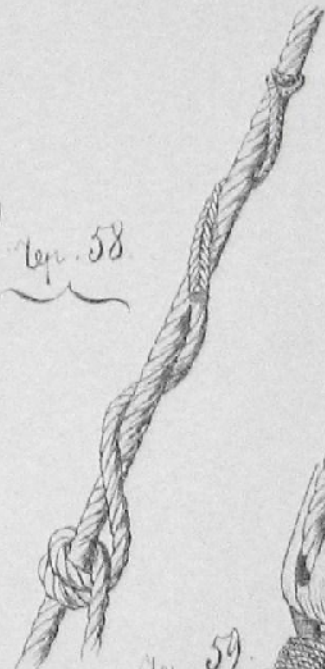
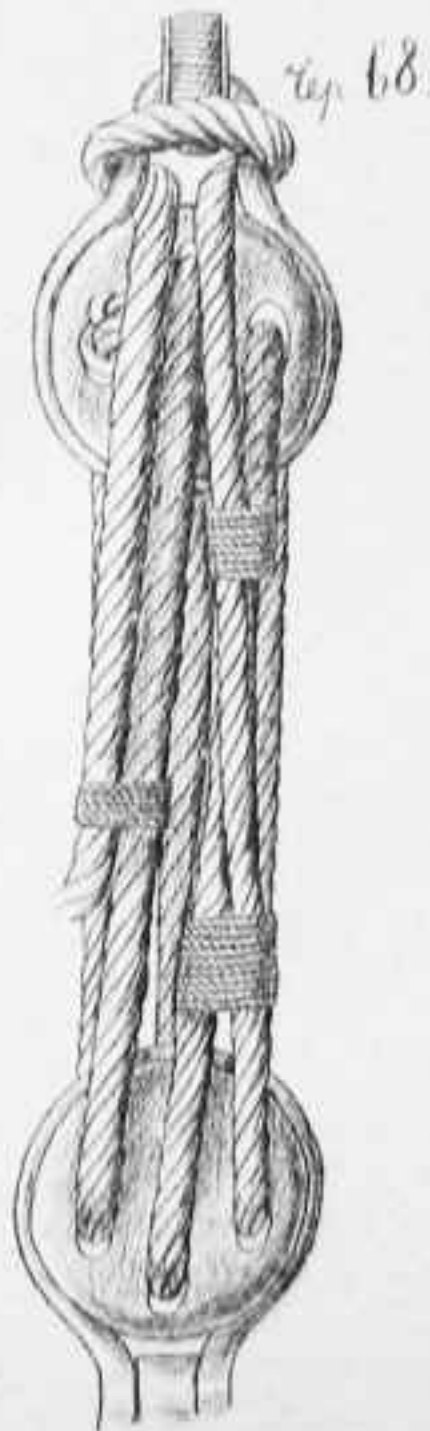
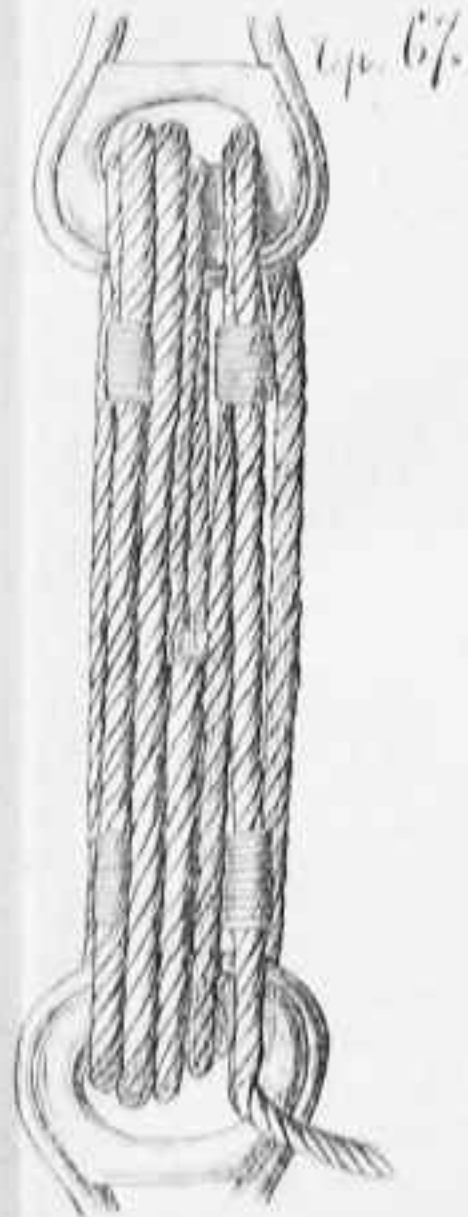
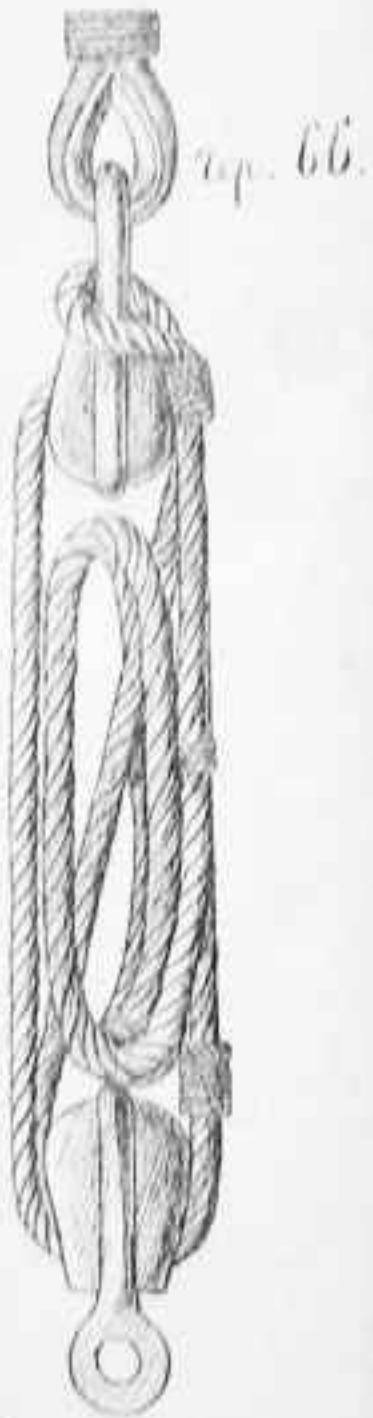
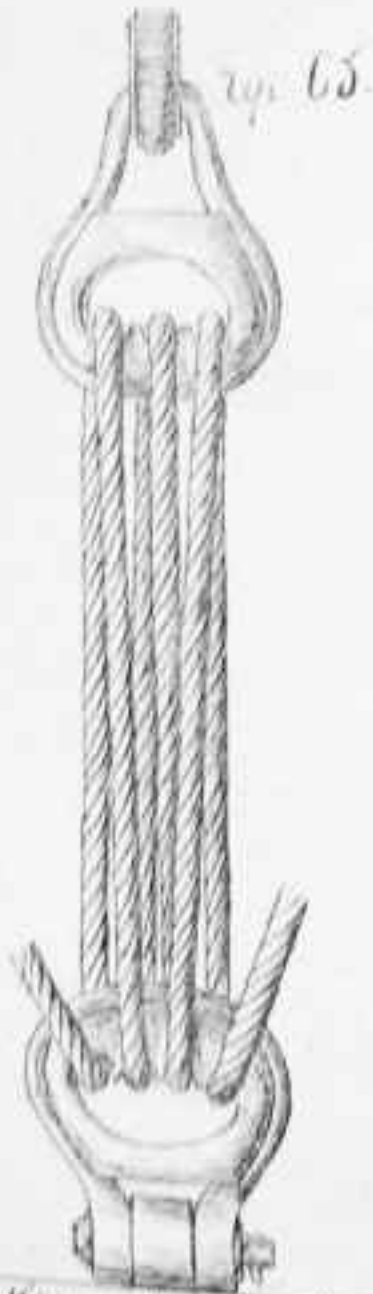
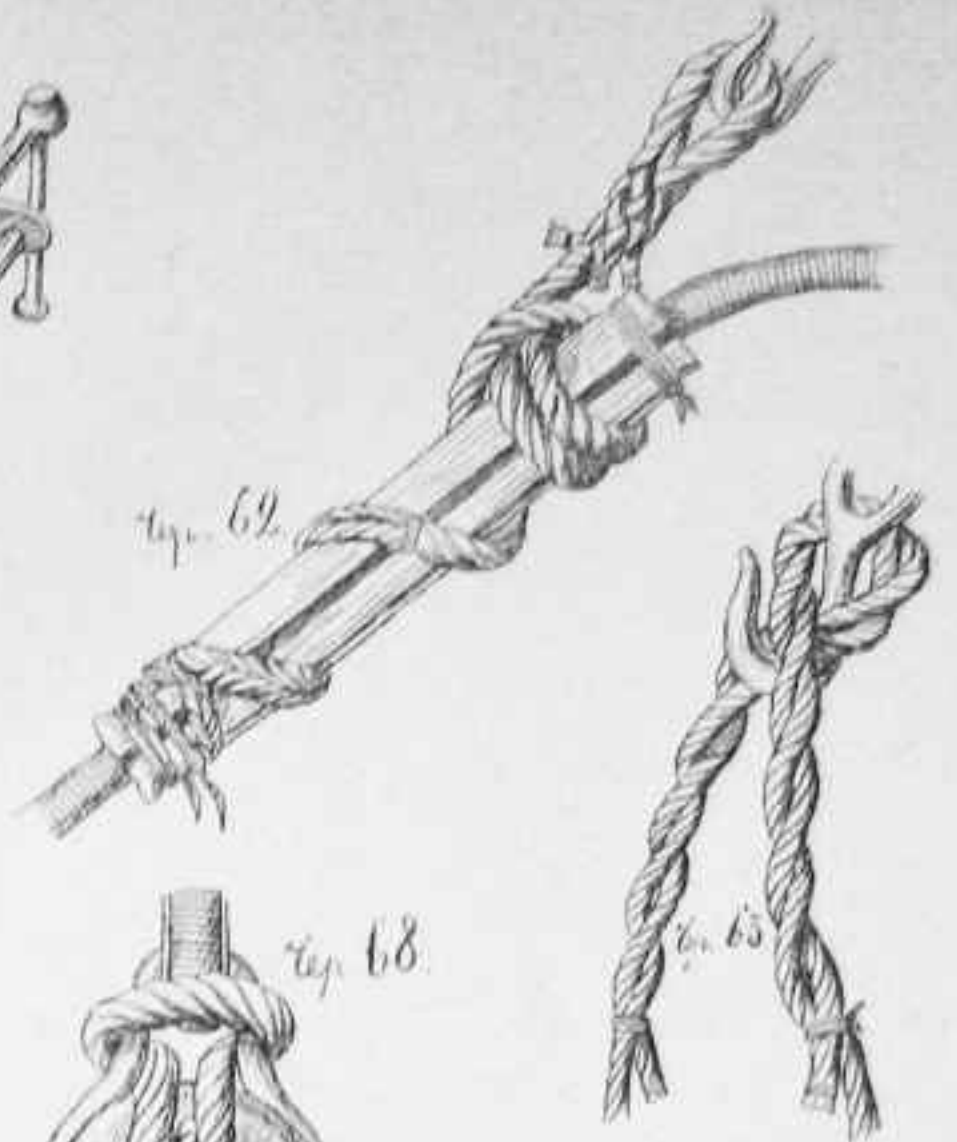
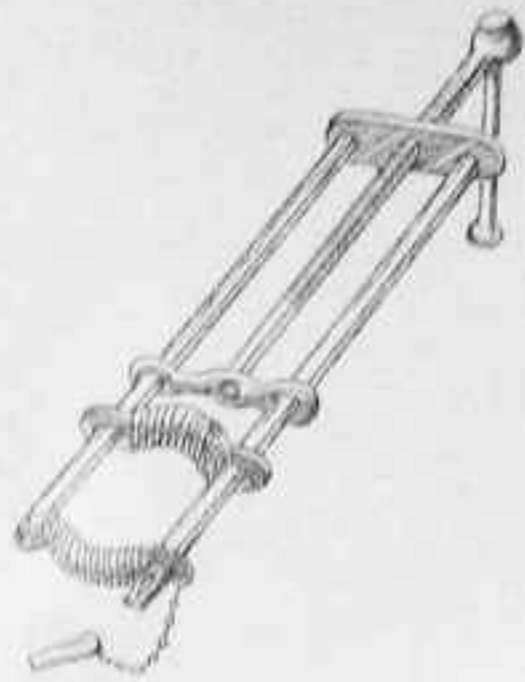
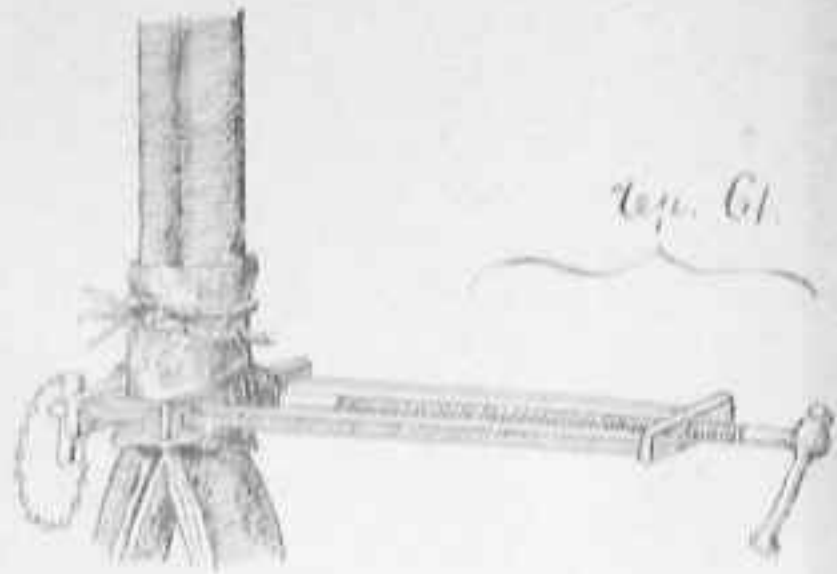

Fig. 59.

Patented by the Inventor

Lucm. 9



Начертание по Спердингу

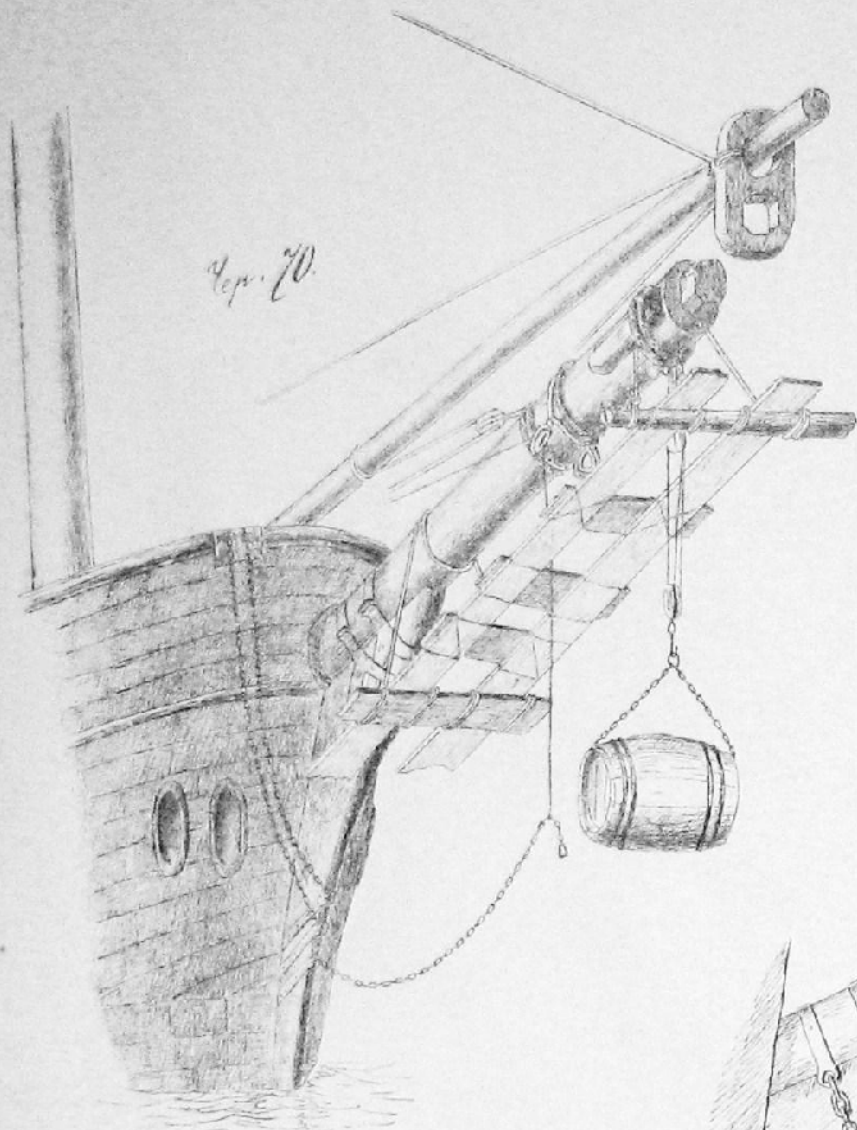

Rep. 70.

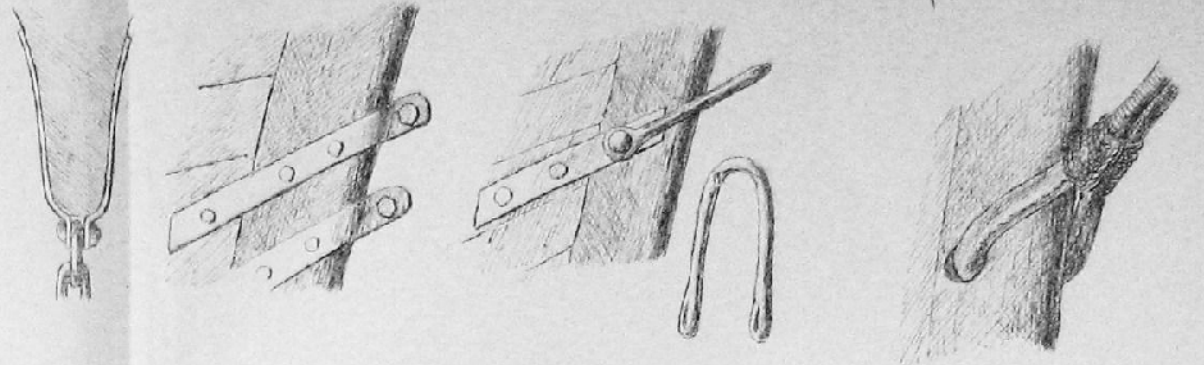

Rep. 72.



Rep. 75.

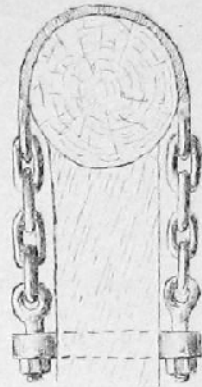
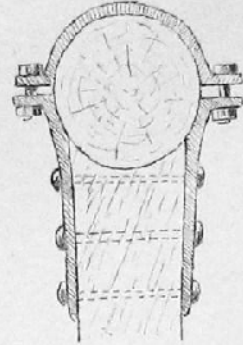

Rep. 73.

Rep. 74.

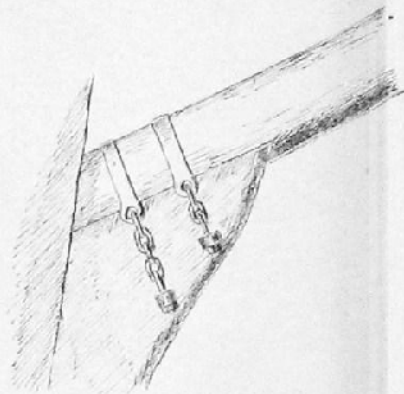

Rep. 74.

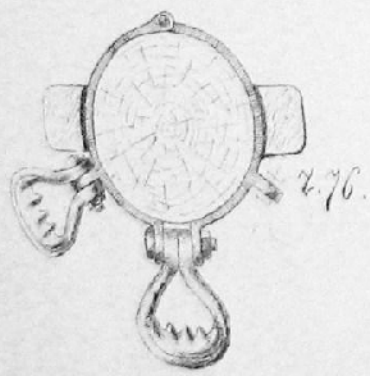
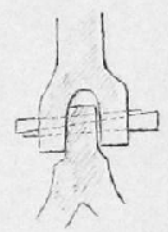
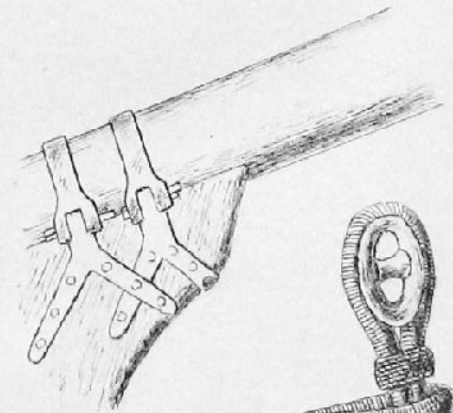

Rep. 76.



Rep. 81.



Rep. 77.

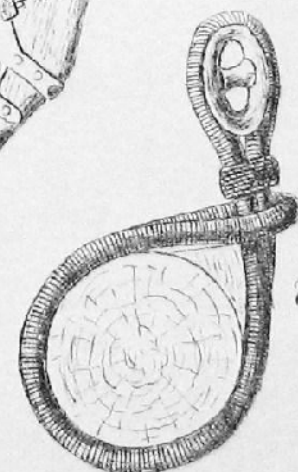

Rep. 78.



Rep. 79.

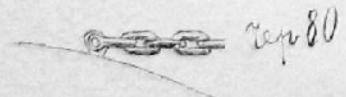

Rep. 80.

Kan for leg buy



Fig. 82

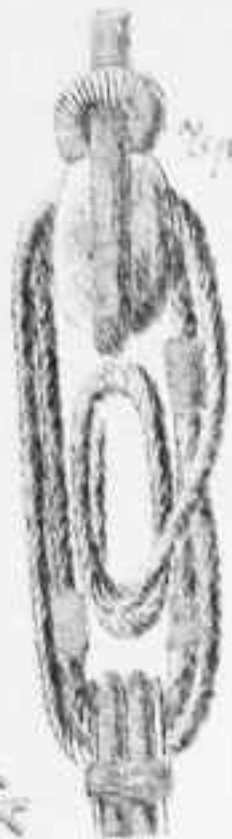

Fig. 83

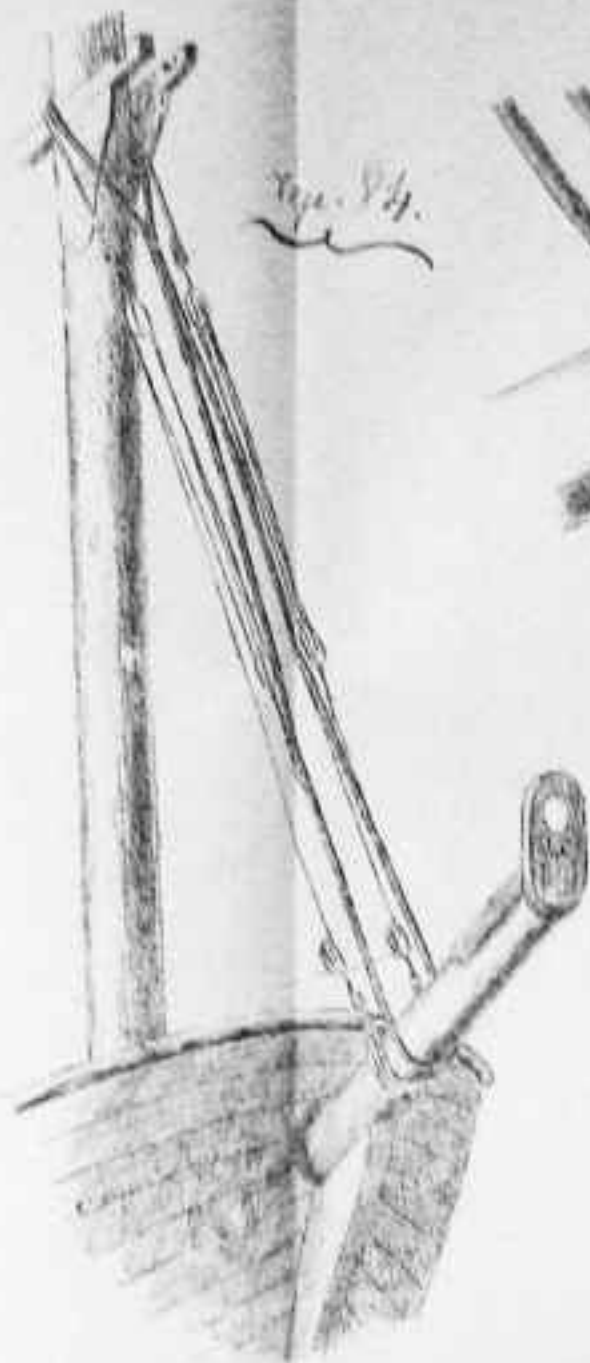

Fig. 84

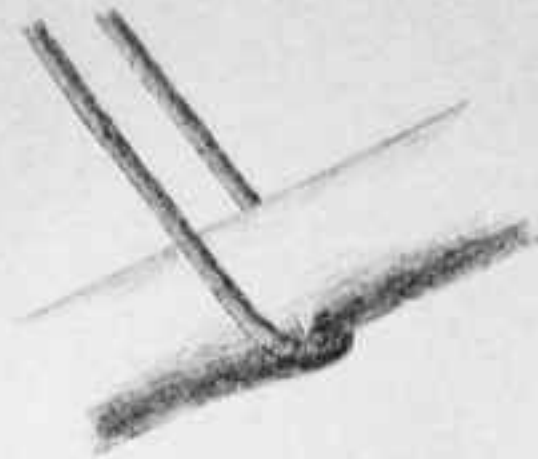

Fig. 85

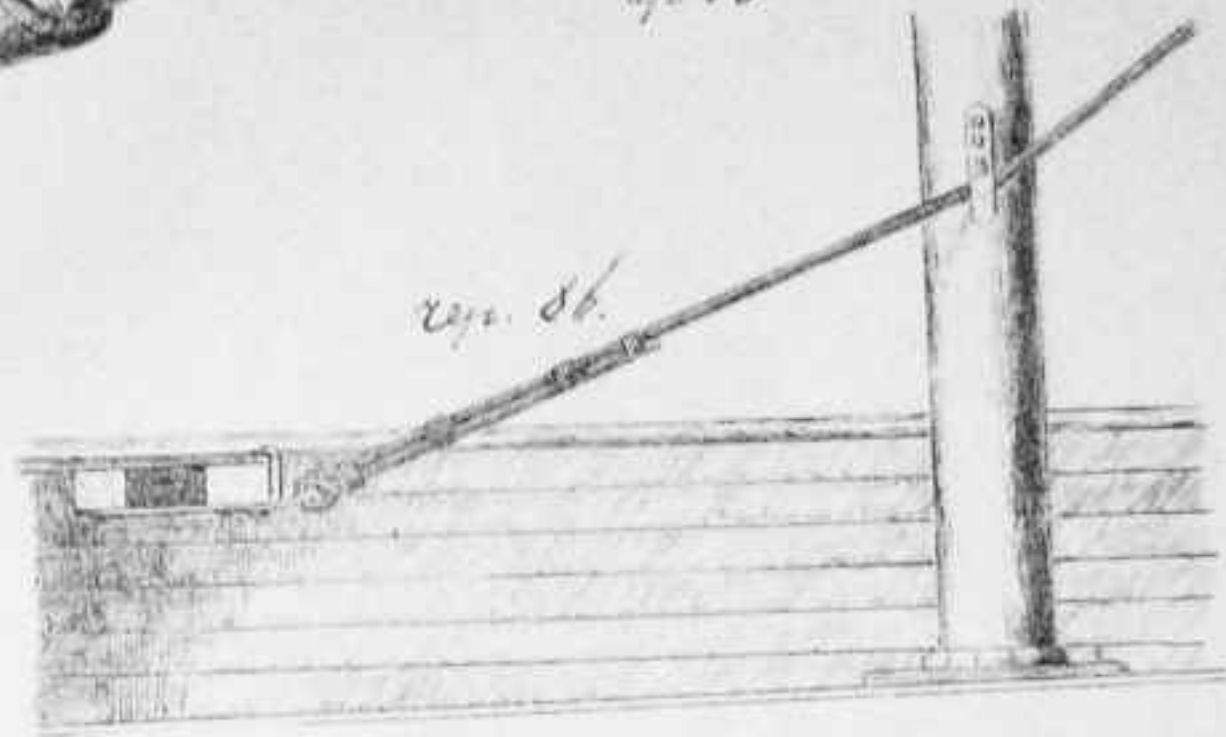

Fig. 86

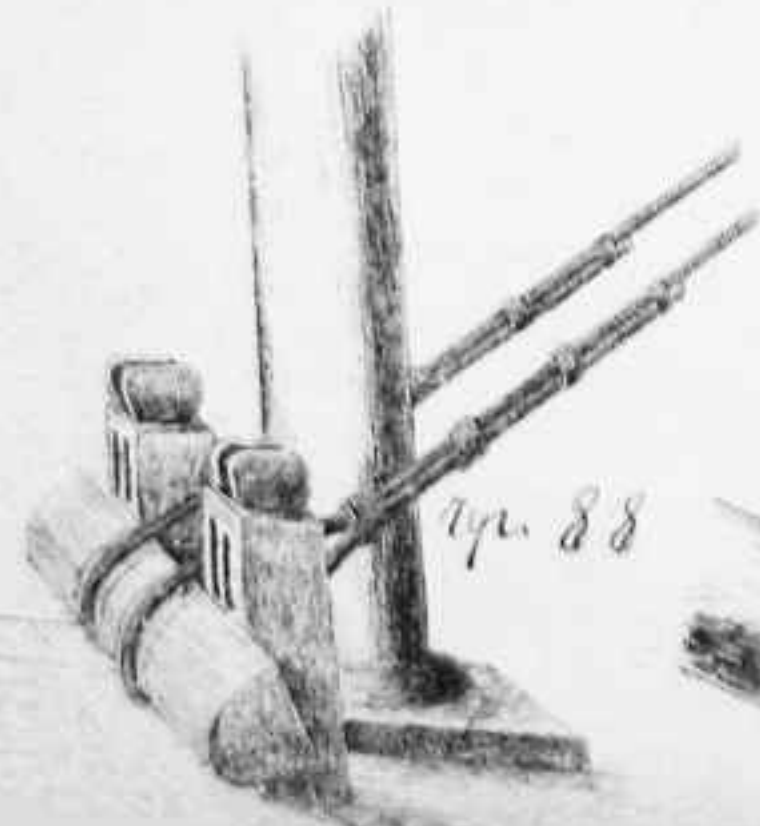

Fig. 88

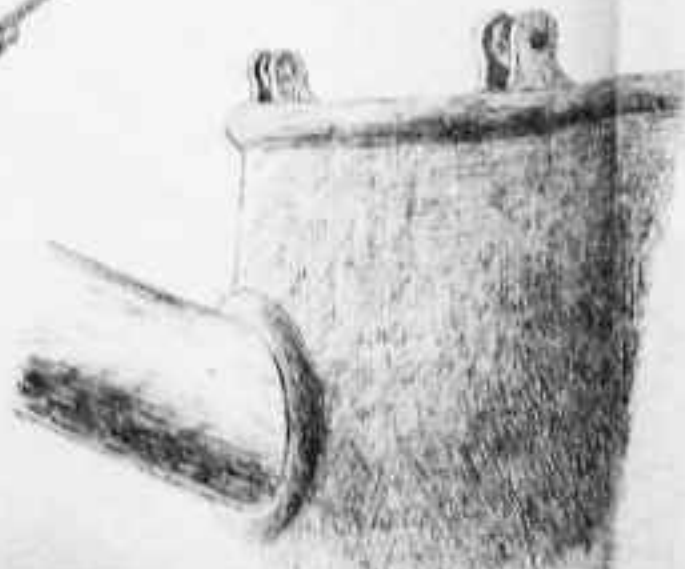

Fig. 87

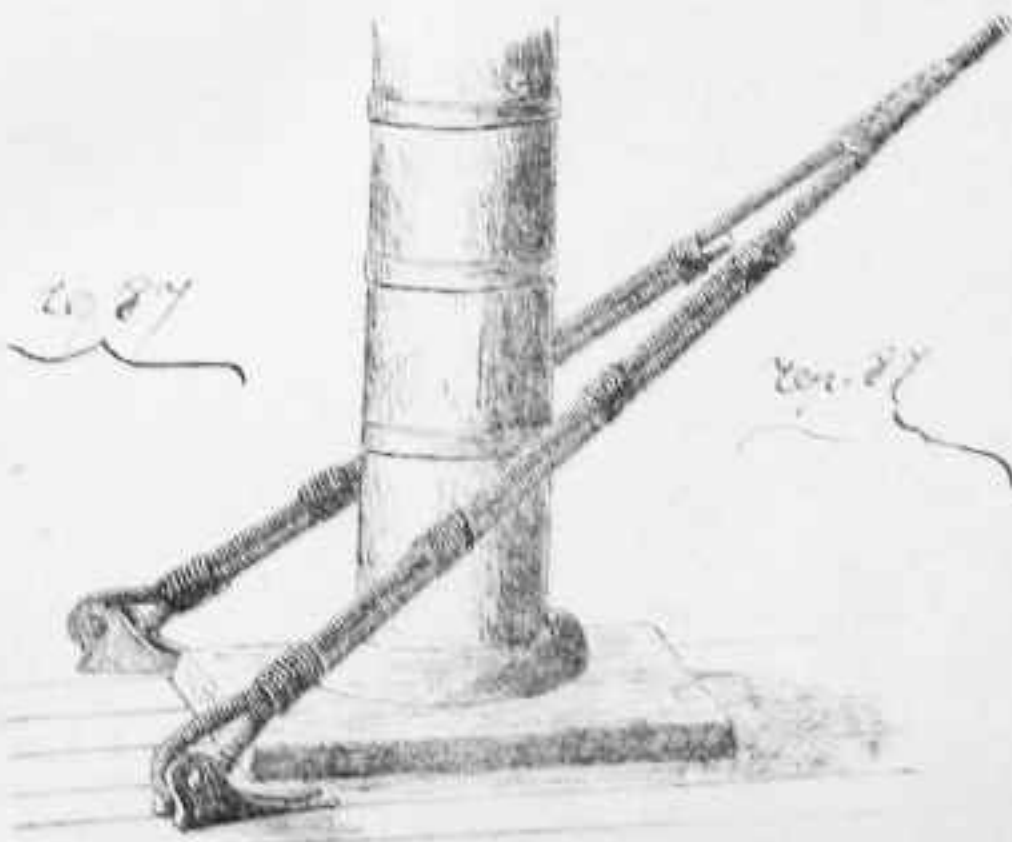

Fig. 89



Plan of Capstan

Fig. 89

с. 100

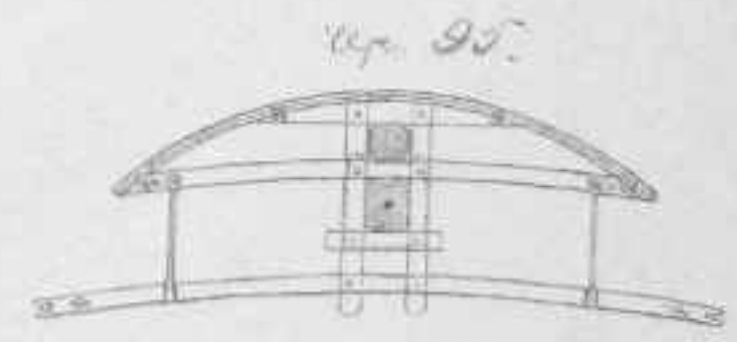
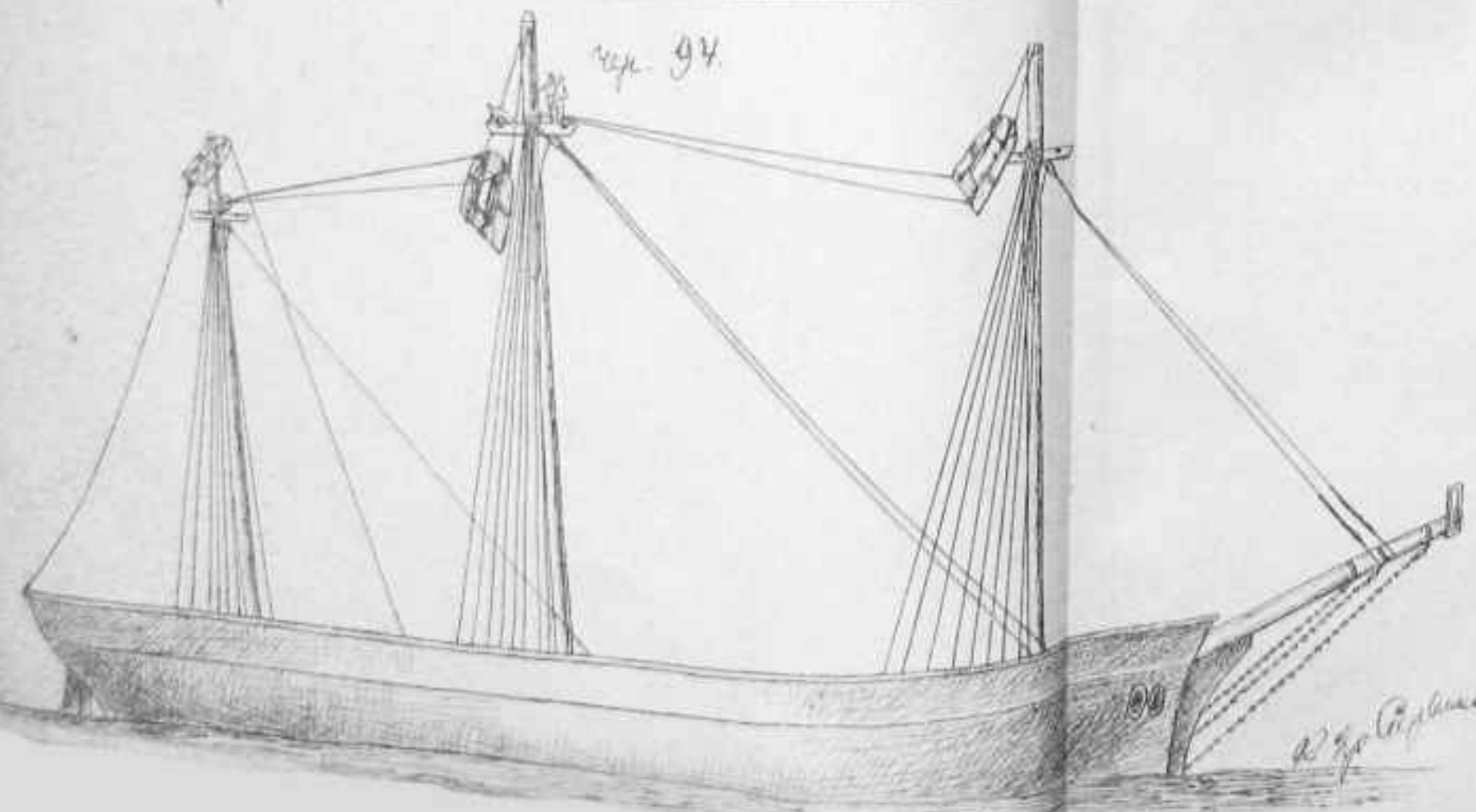
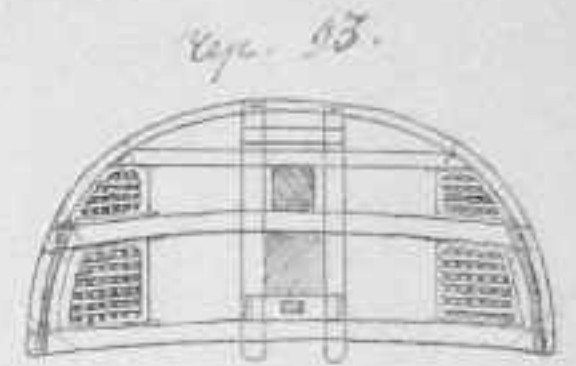
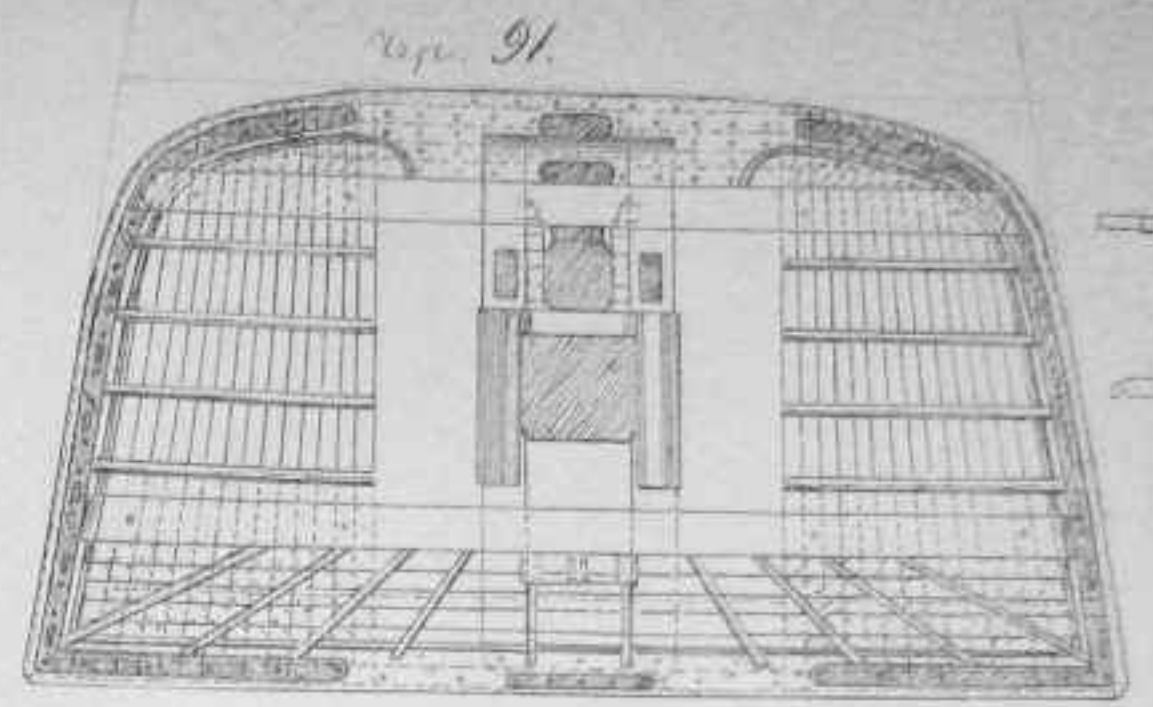
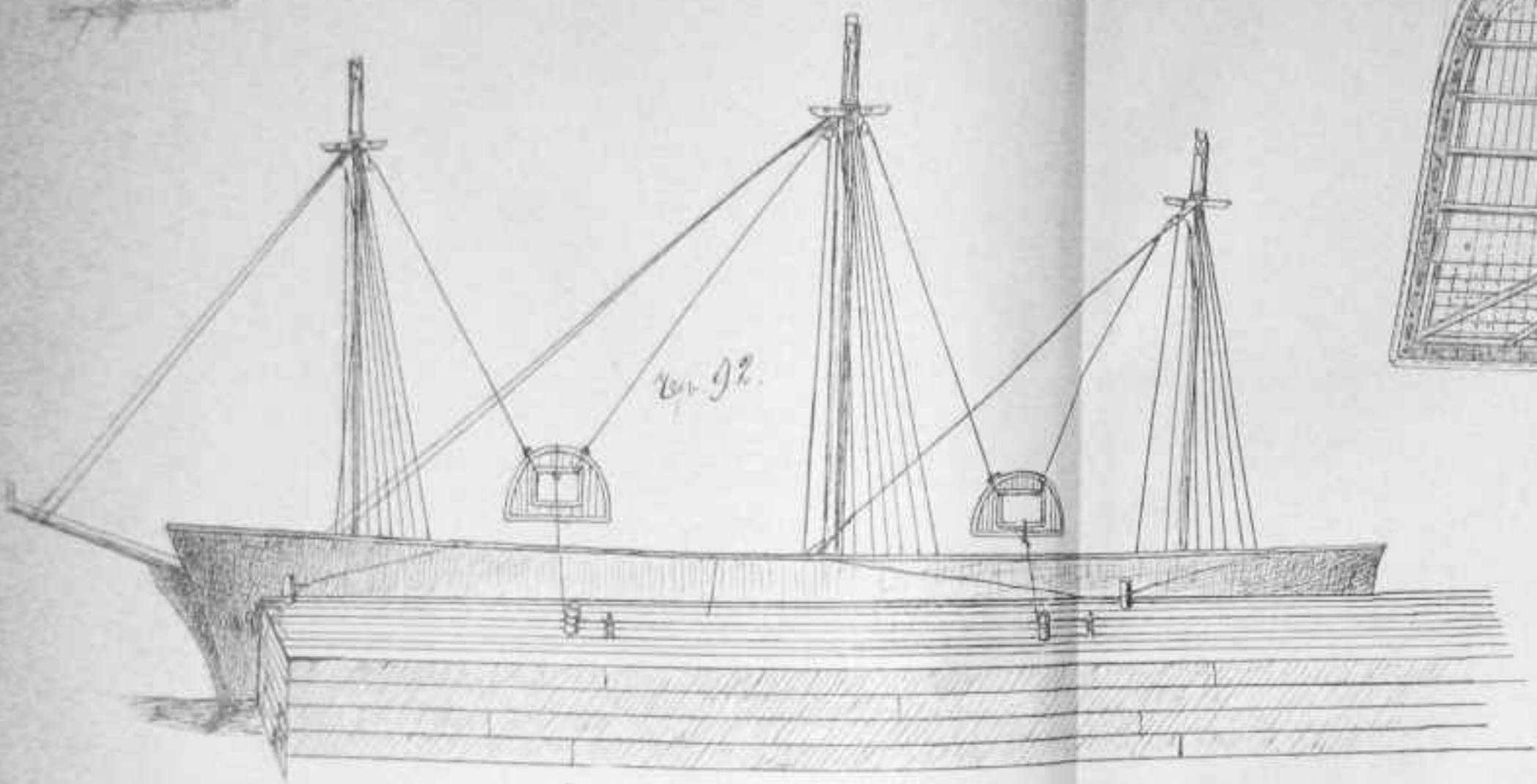

с. 101

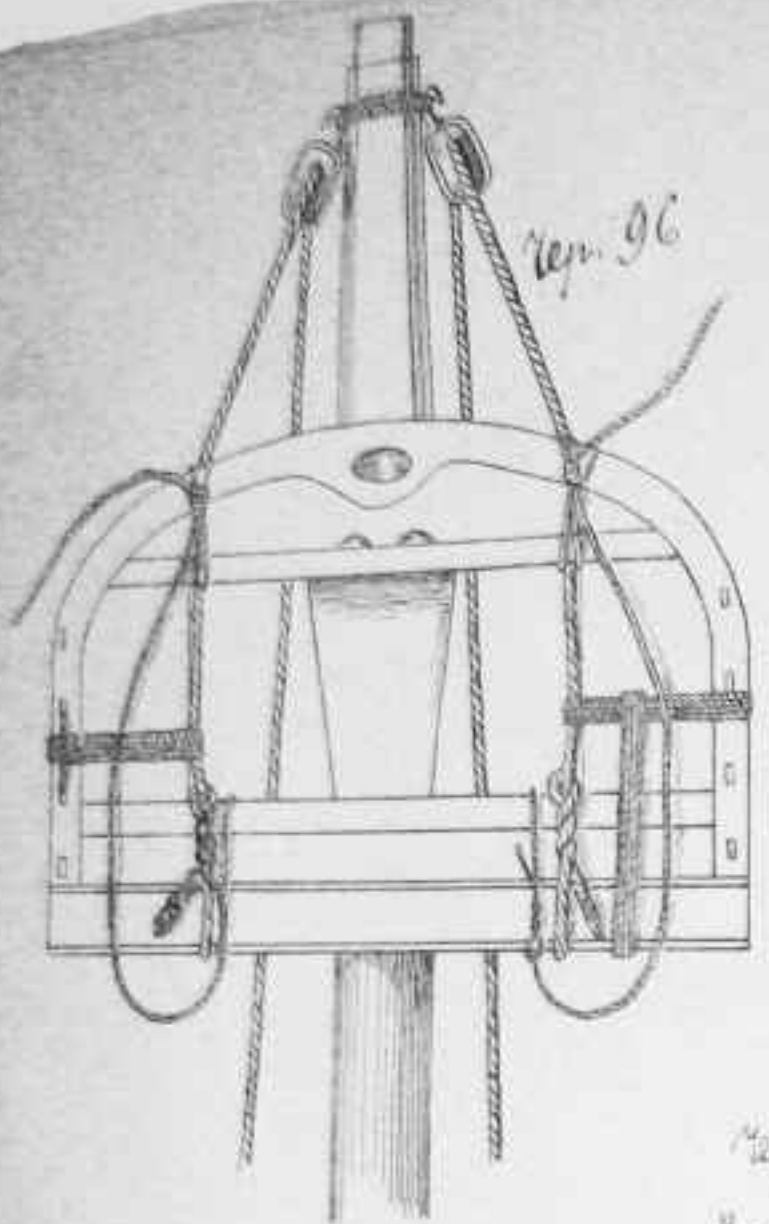

Fig. 96

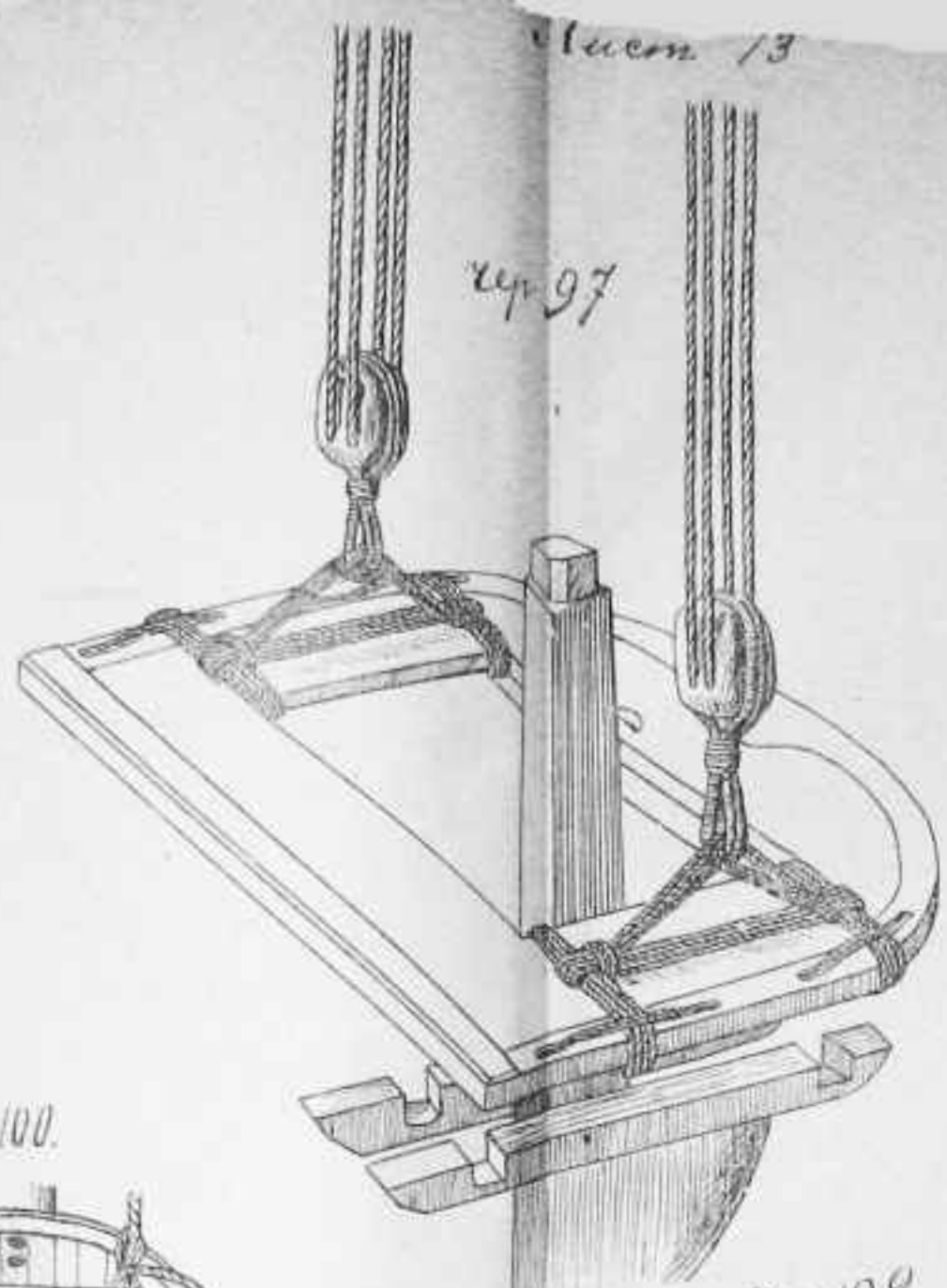

Fig. 97

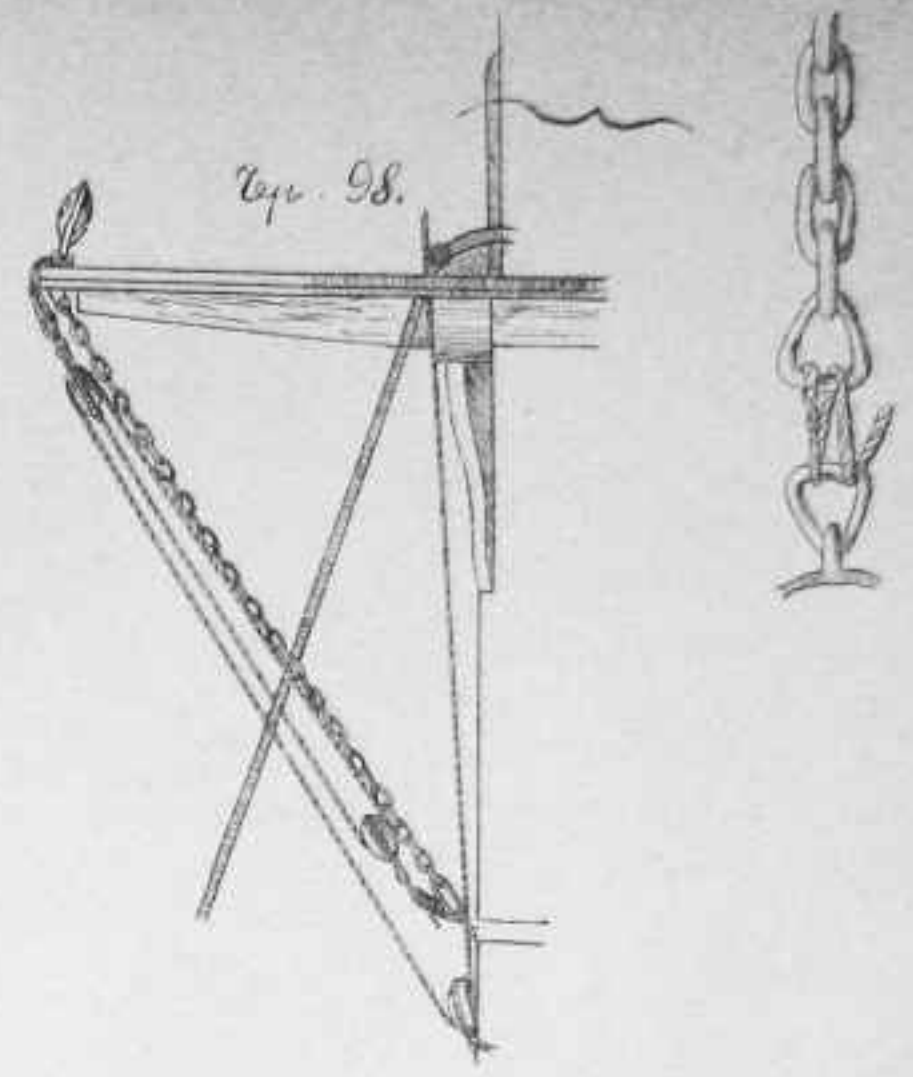

Fig. 98

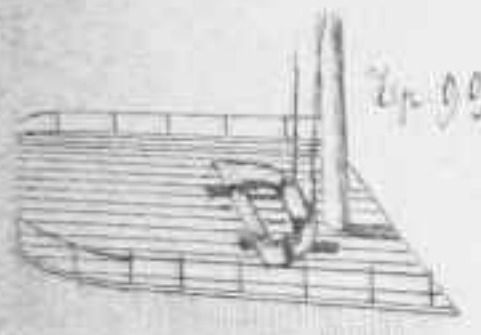

Fig. 99

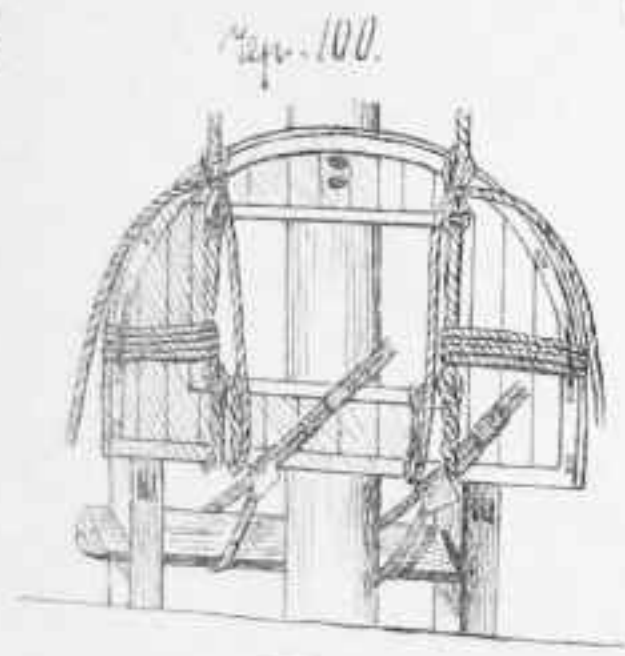

Fig. 100



Fig. 101



Fig. 102



Fig. 103

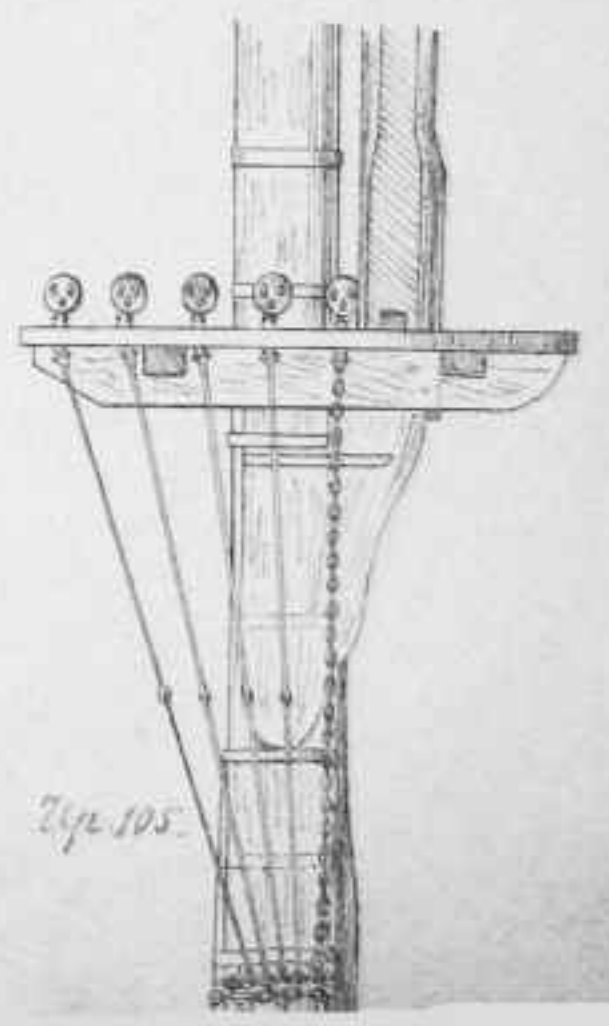
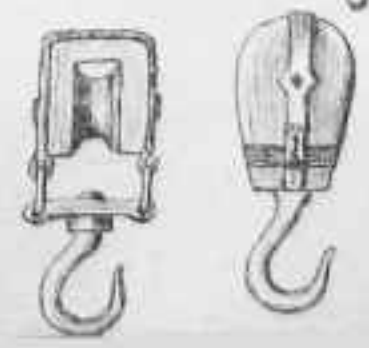
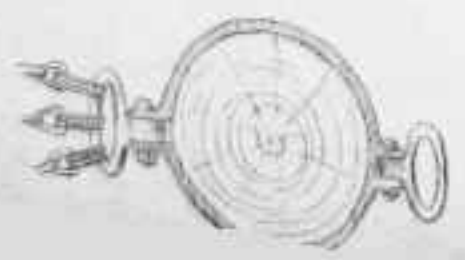
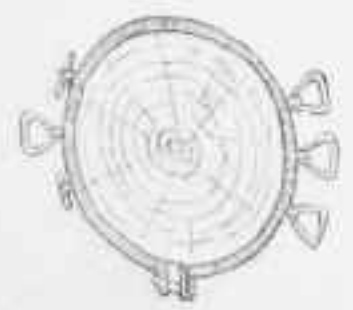

Fig. 105



Fig. 104



с люкром 14.



тип 106.

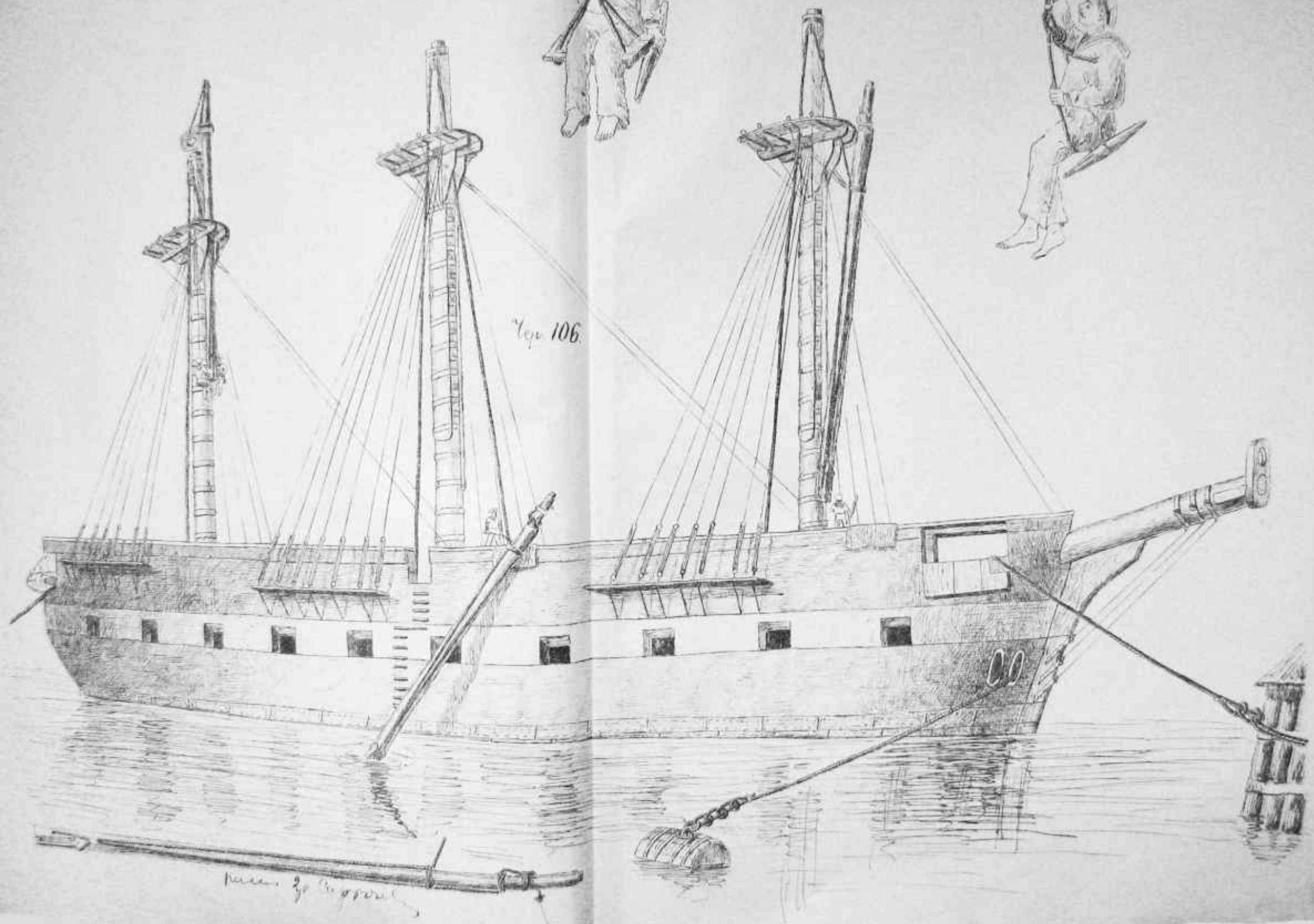

рус. 30 апреля

Invent. 15.

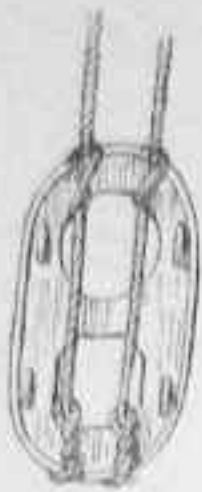
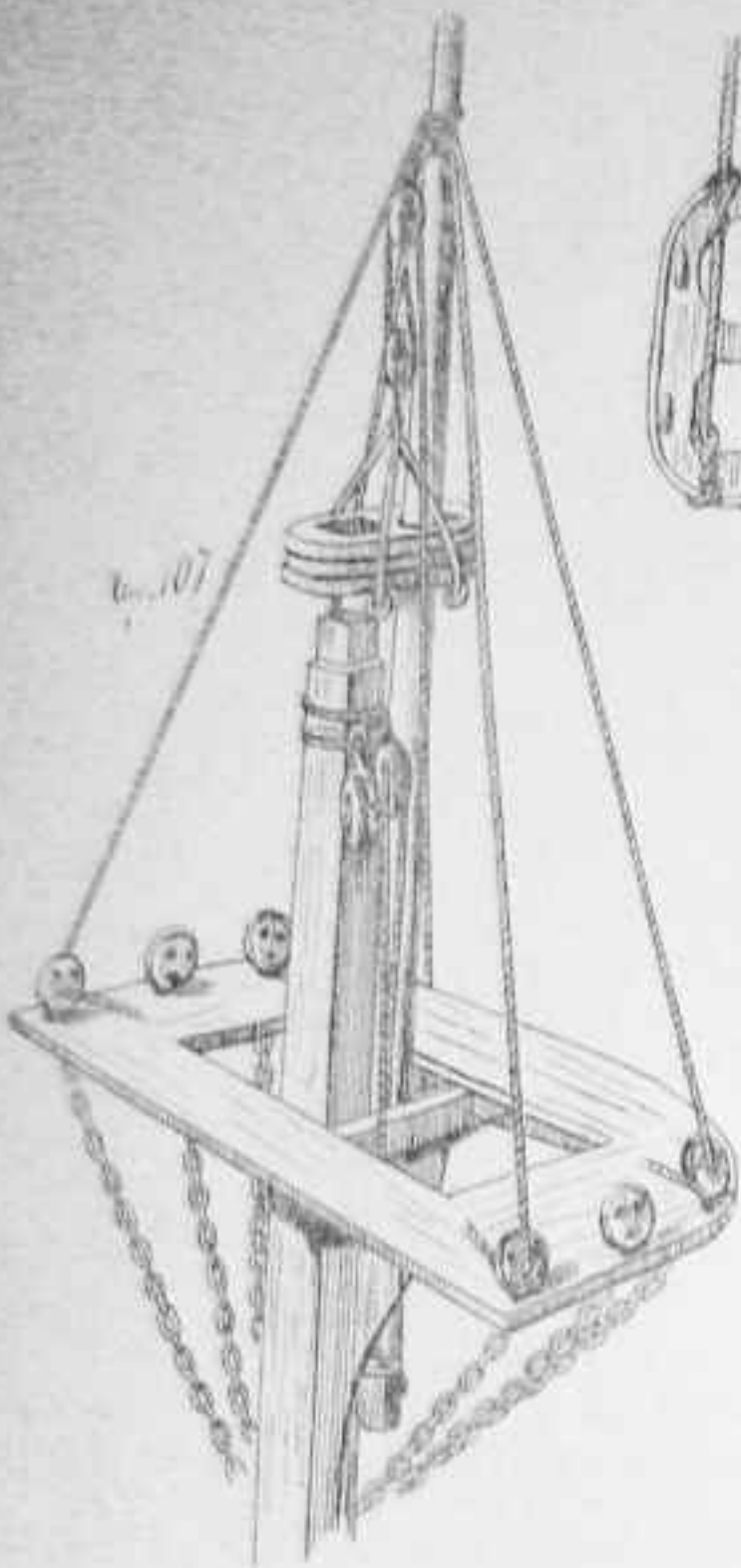

Fig. 108

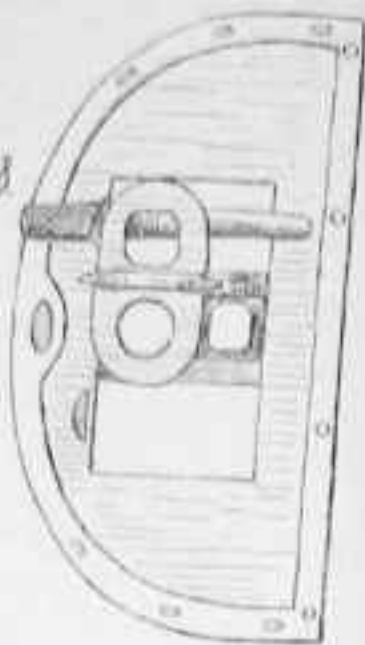

Fig. 109

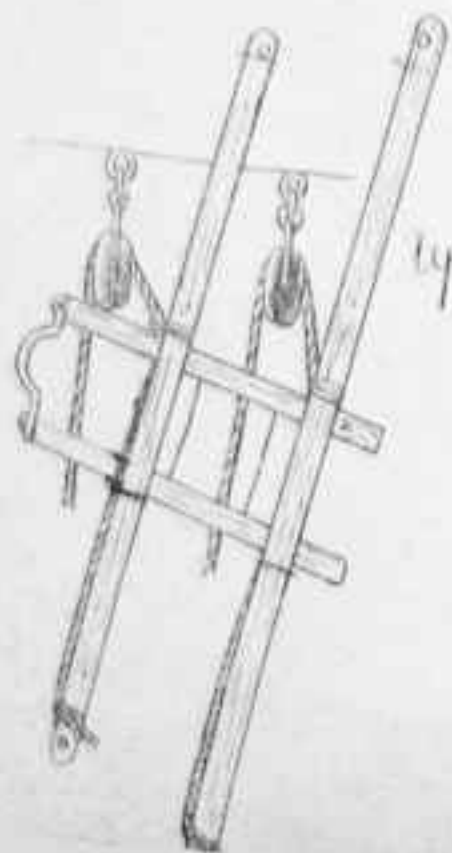
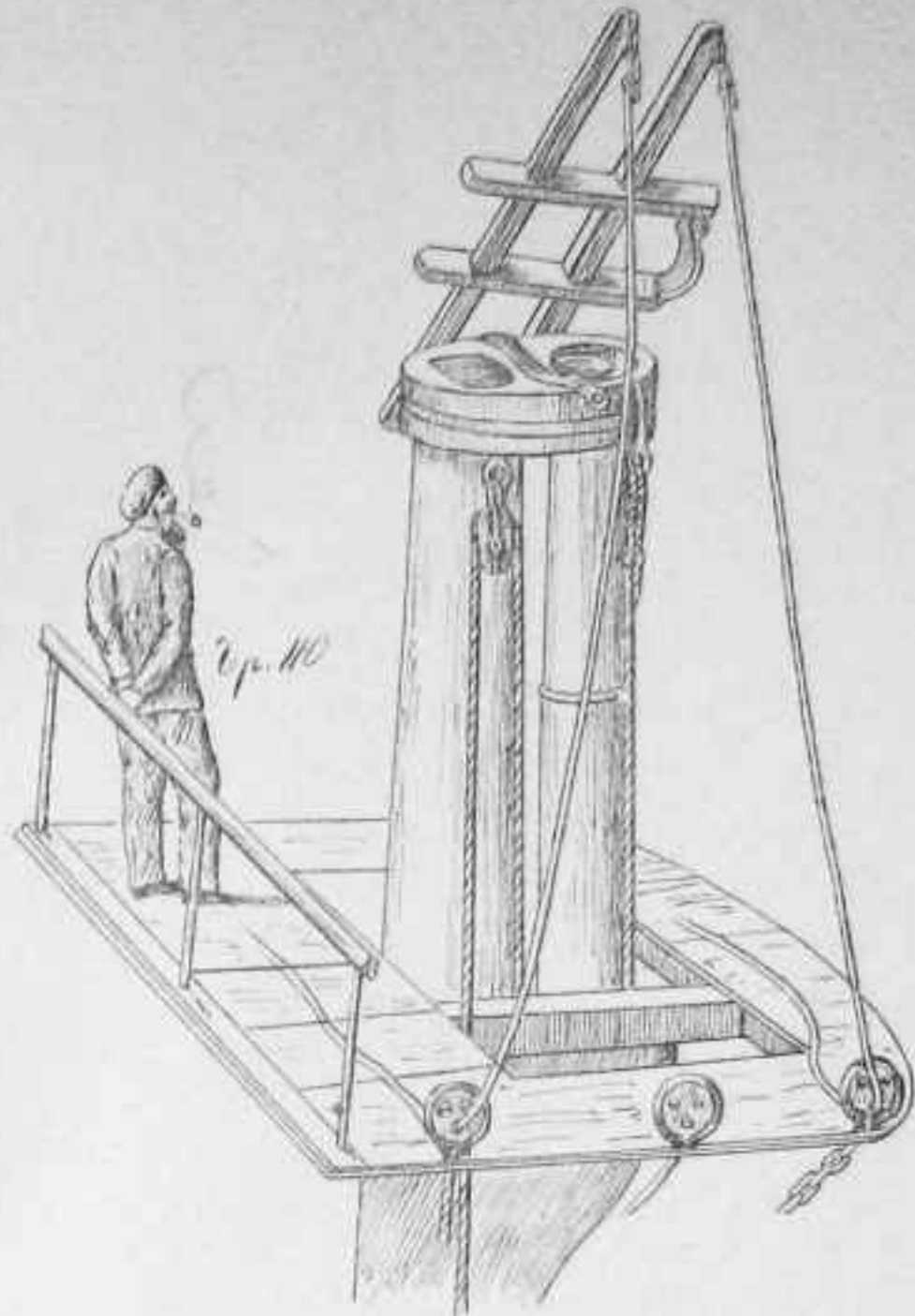
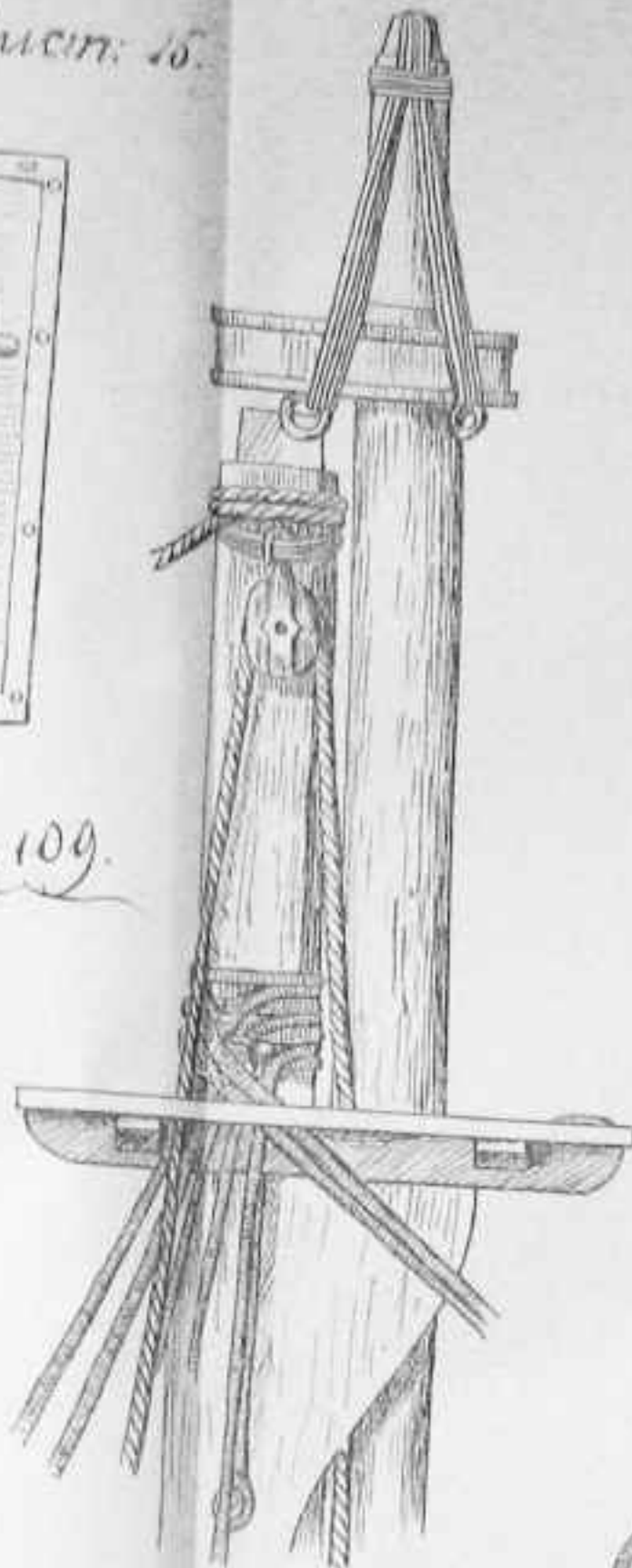

Fig. 111

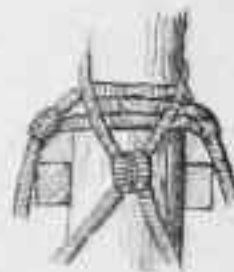

Fig. 112

Hand of the Inventor



Fig. 113



Stems 16.



Fig. 115

Fig. 114

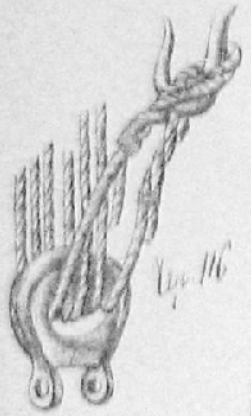
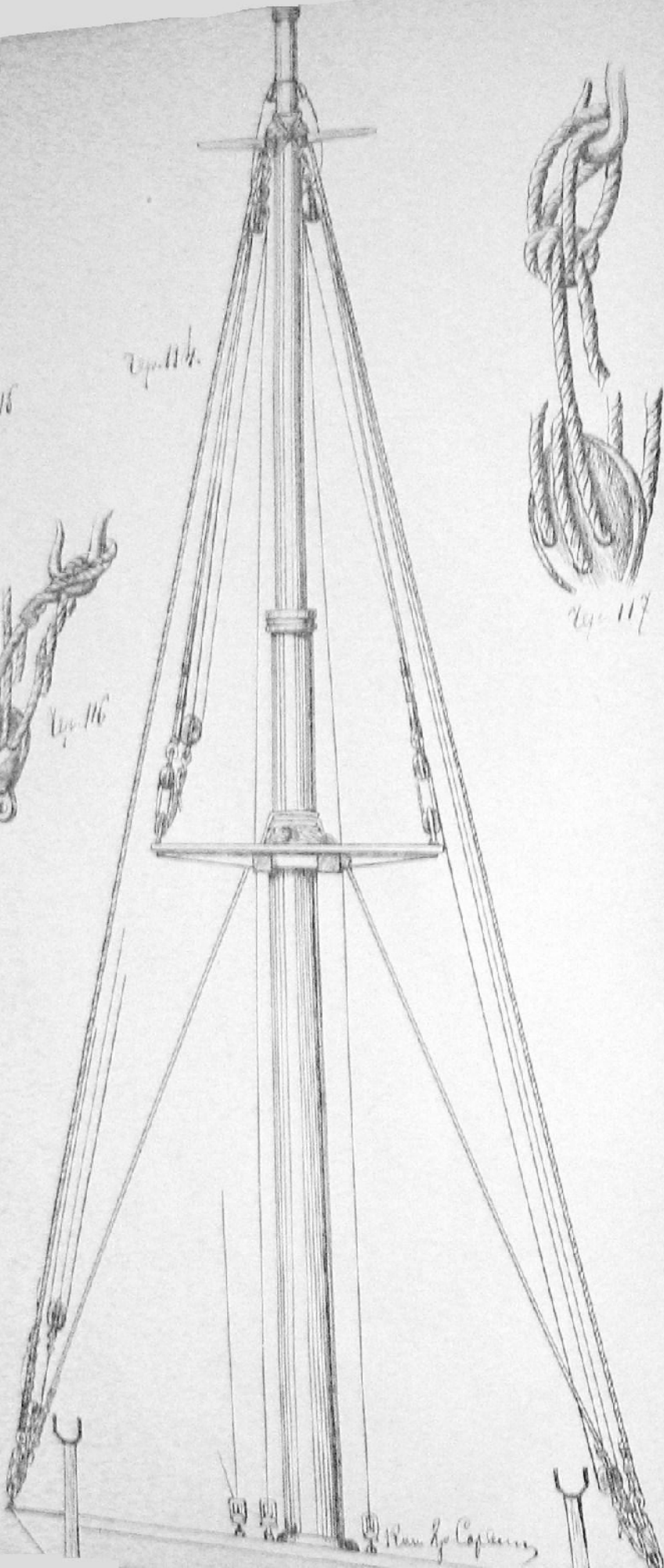

Fig. 116



Fig. 117



Wm. L. Capron

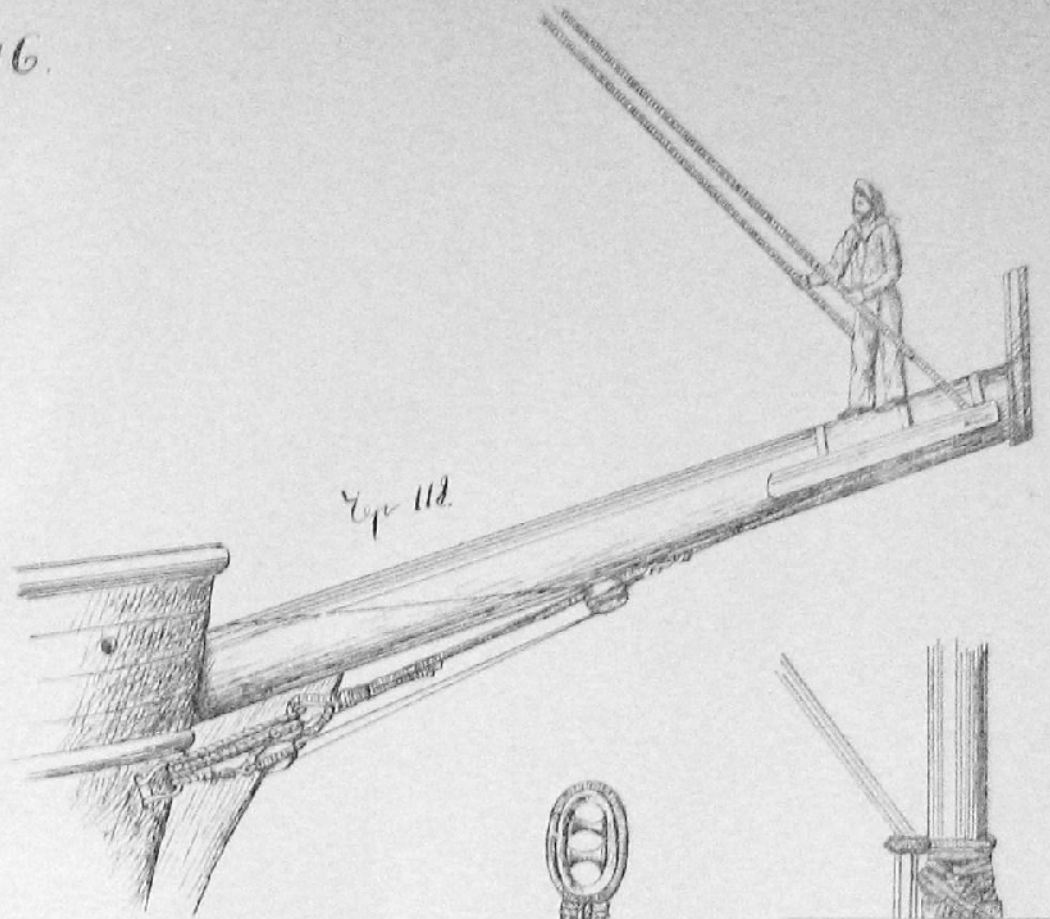

Fig. 118



Fig. 120

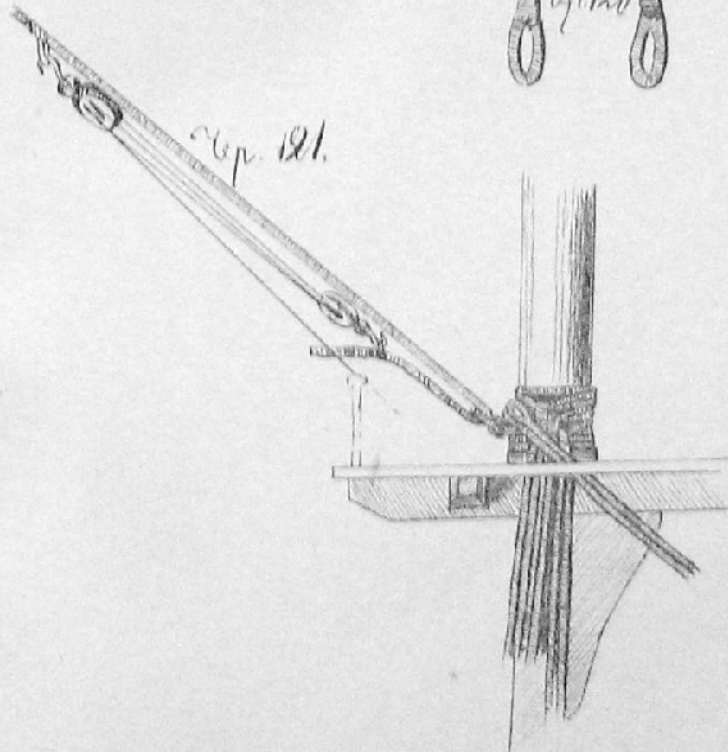

Fig. 121

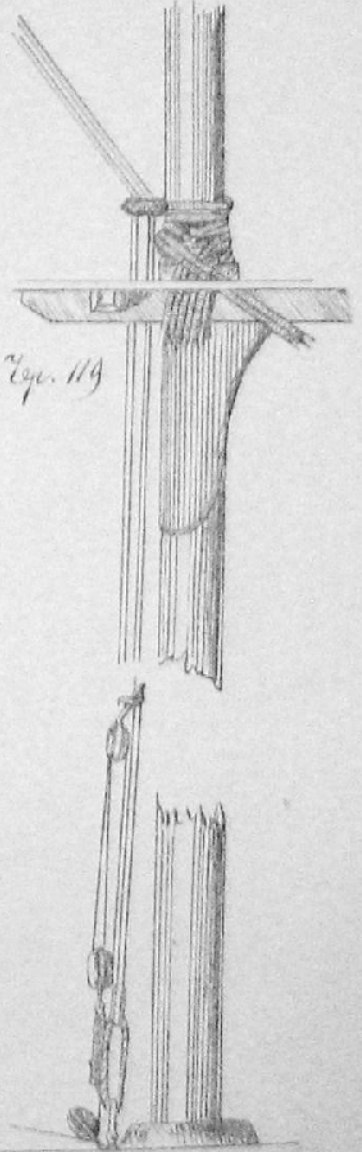
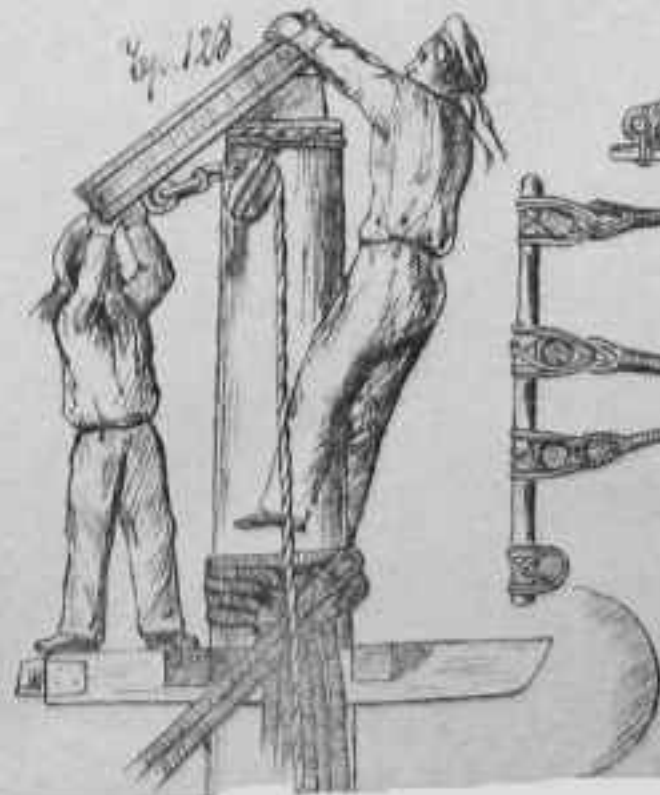
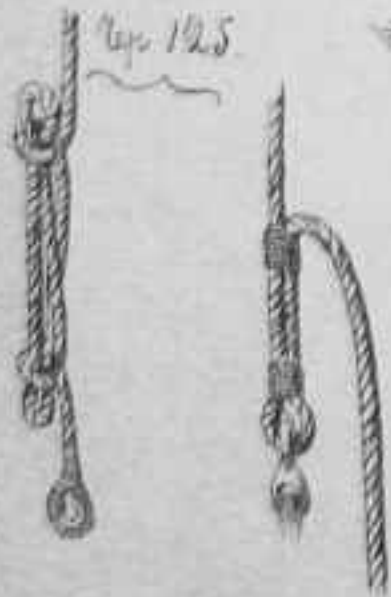
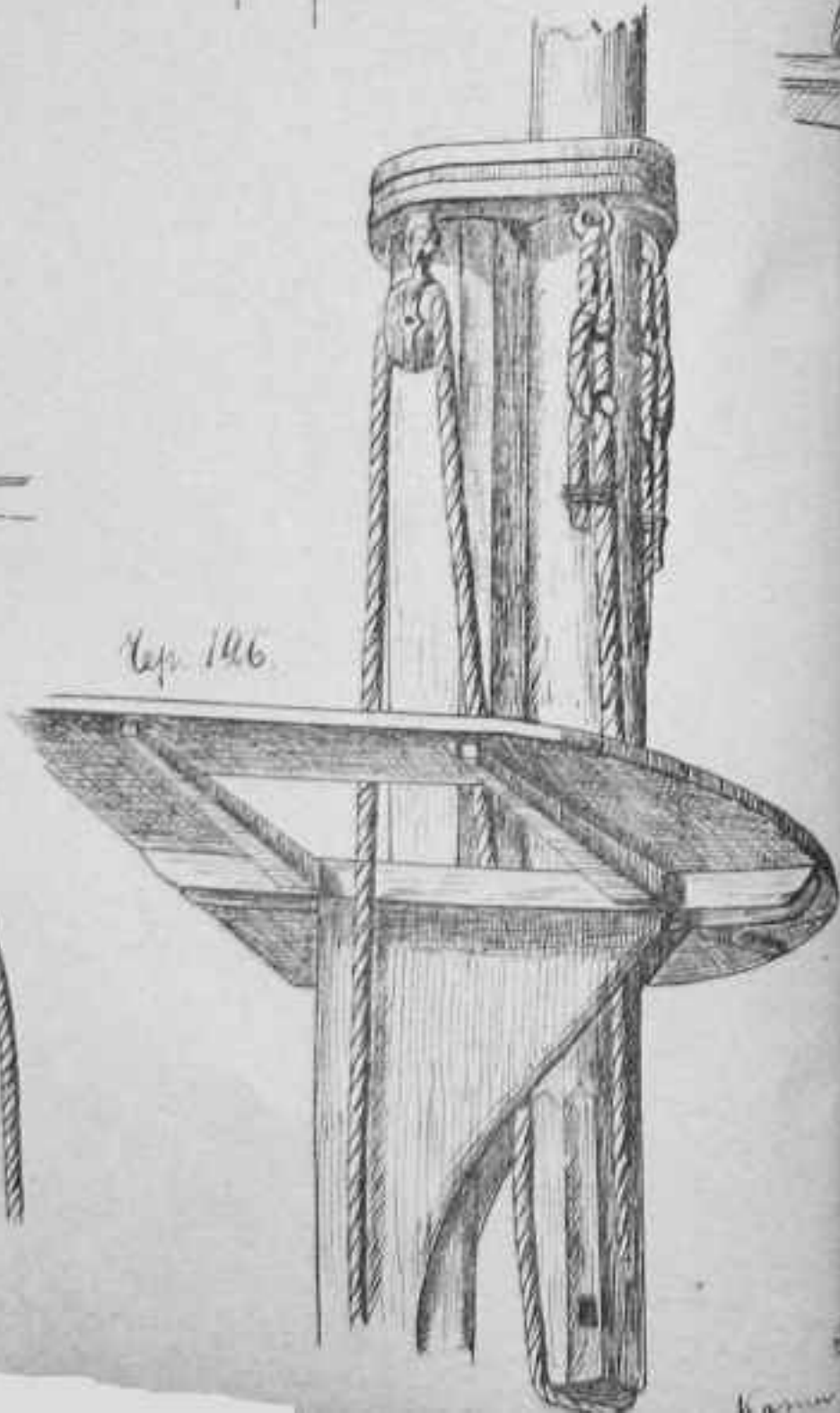
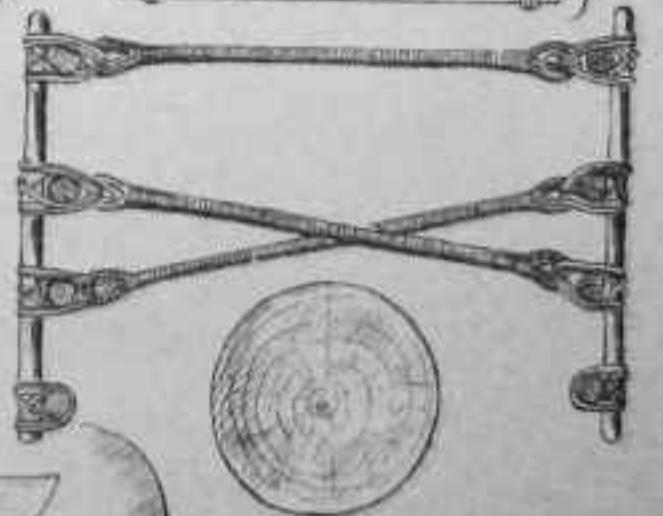
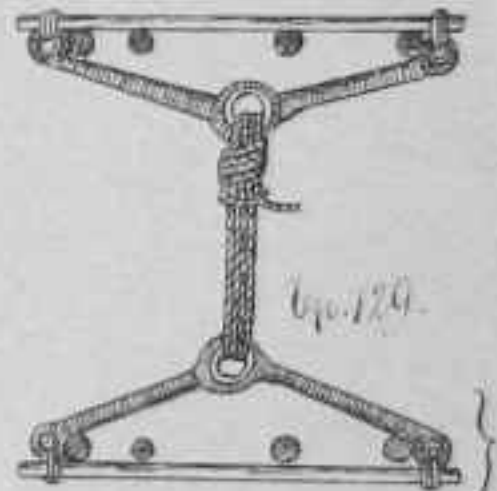
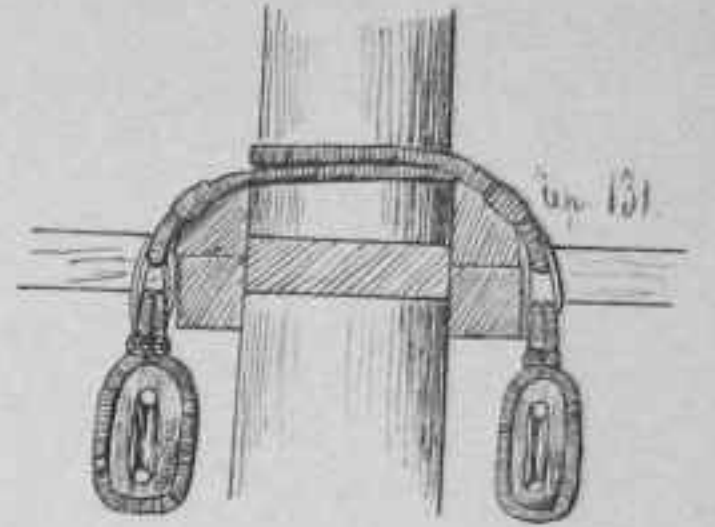
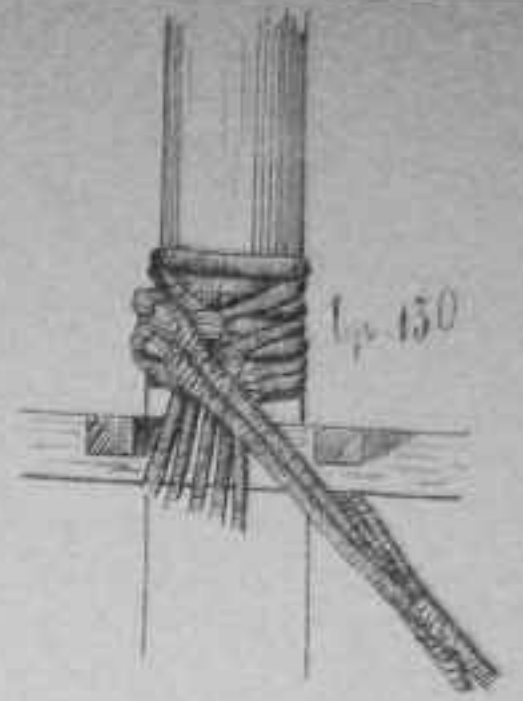
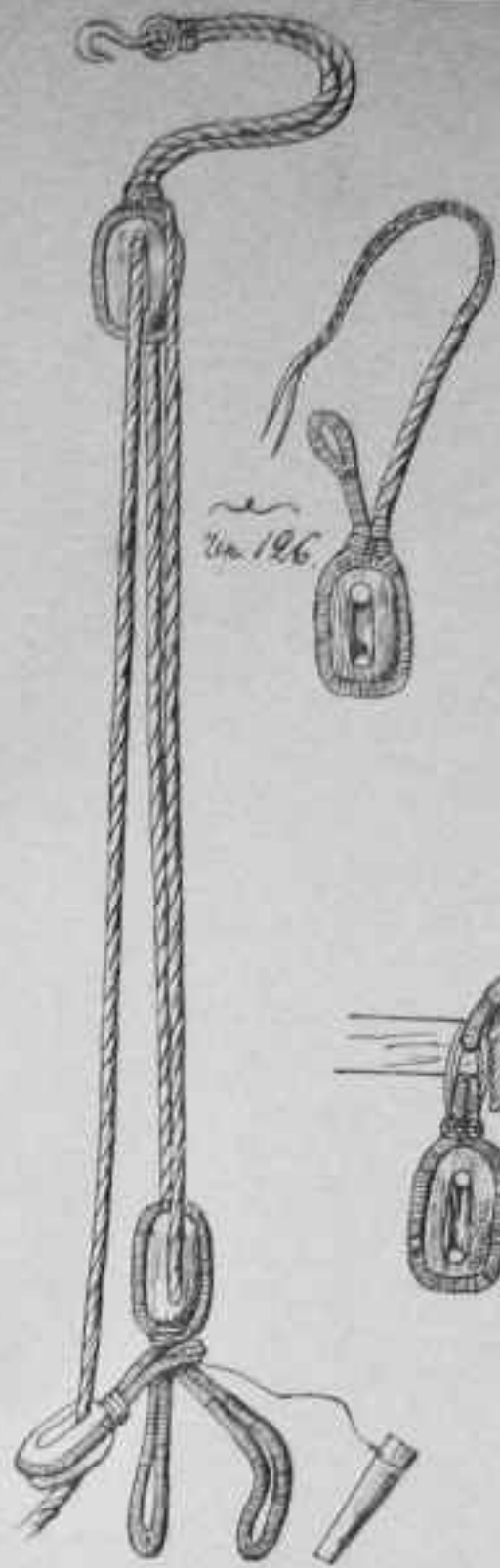
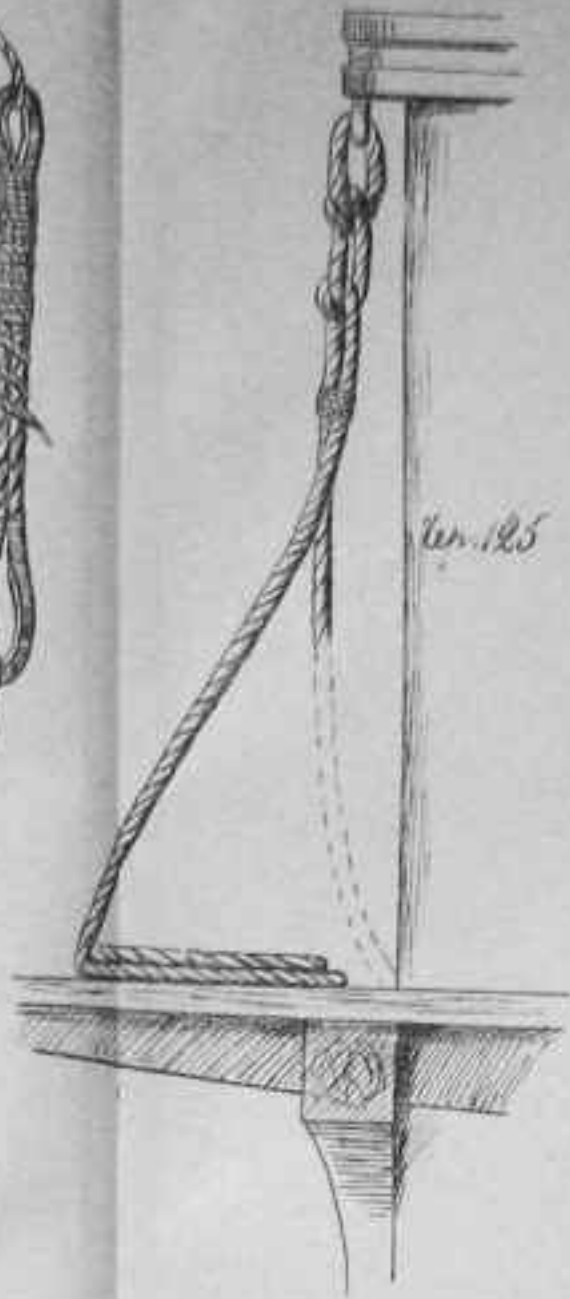
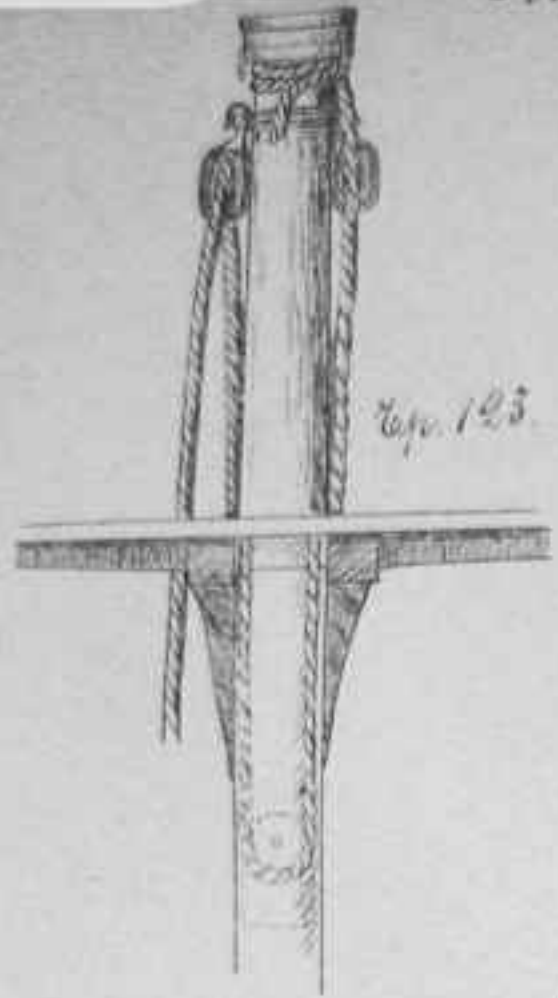
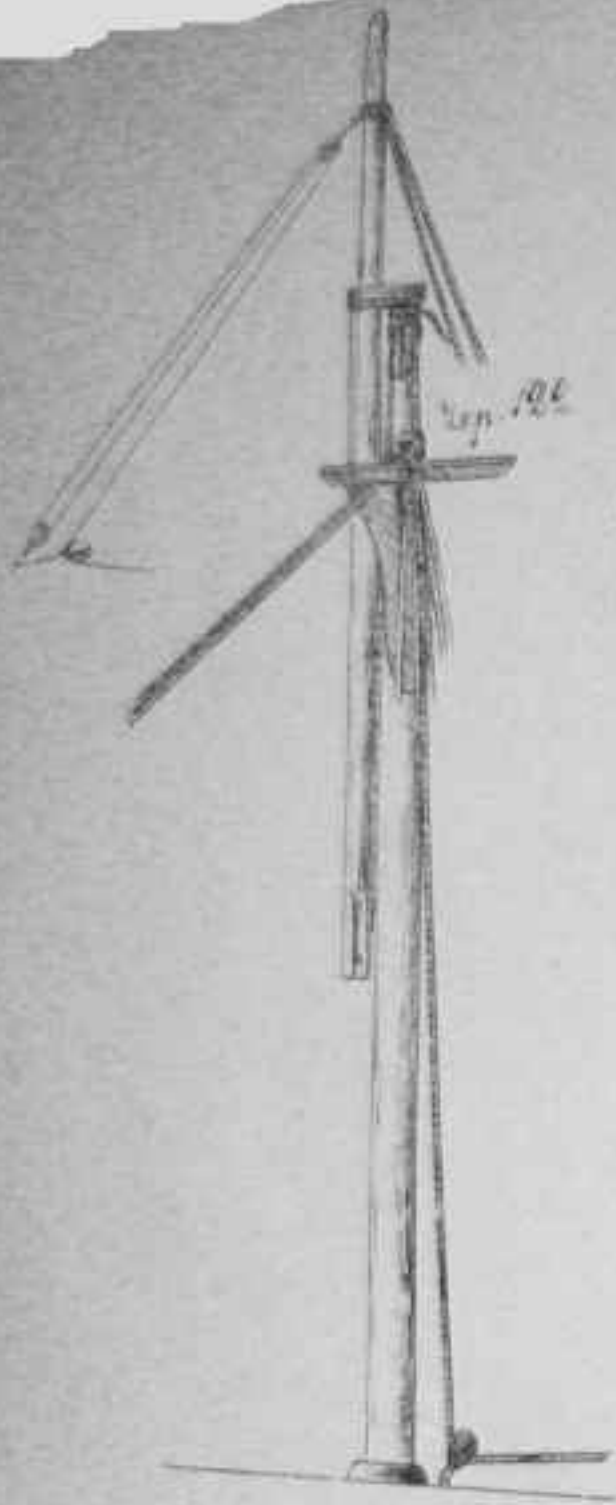
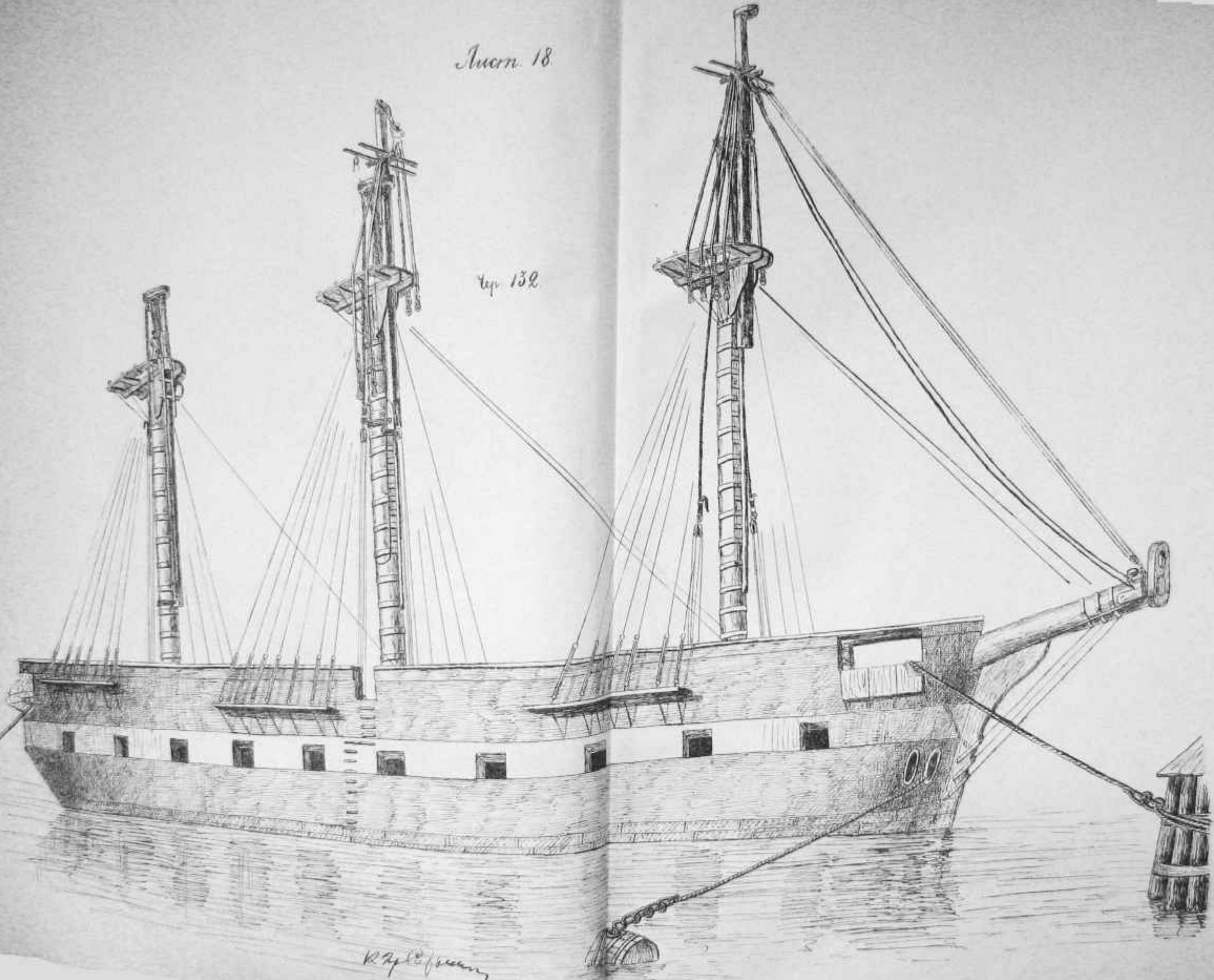

Fig. 119



Aug. 18.

Fig. 132.



W. H. P. Johnson

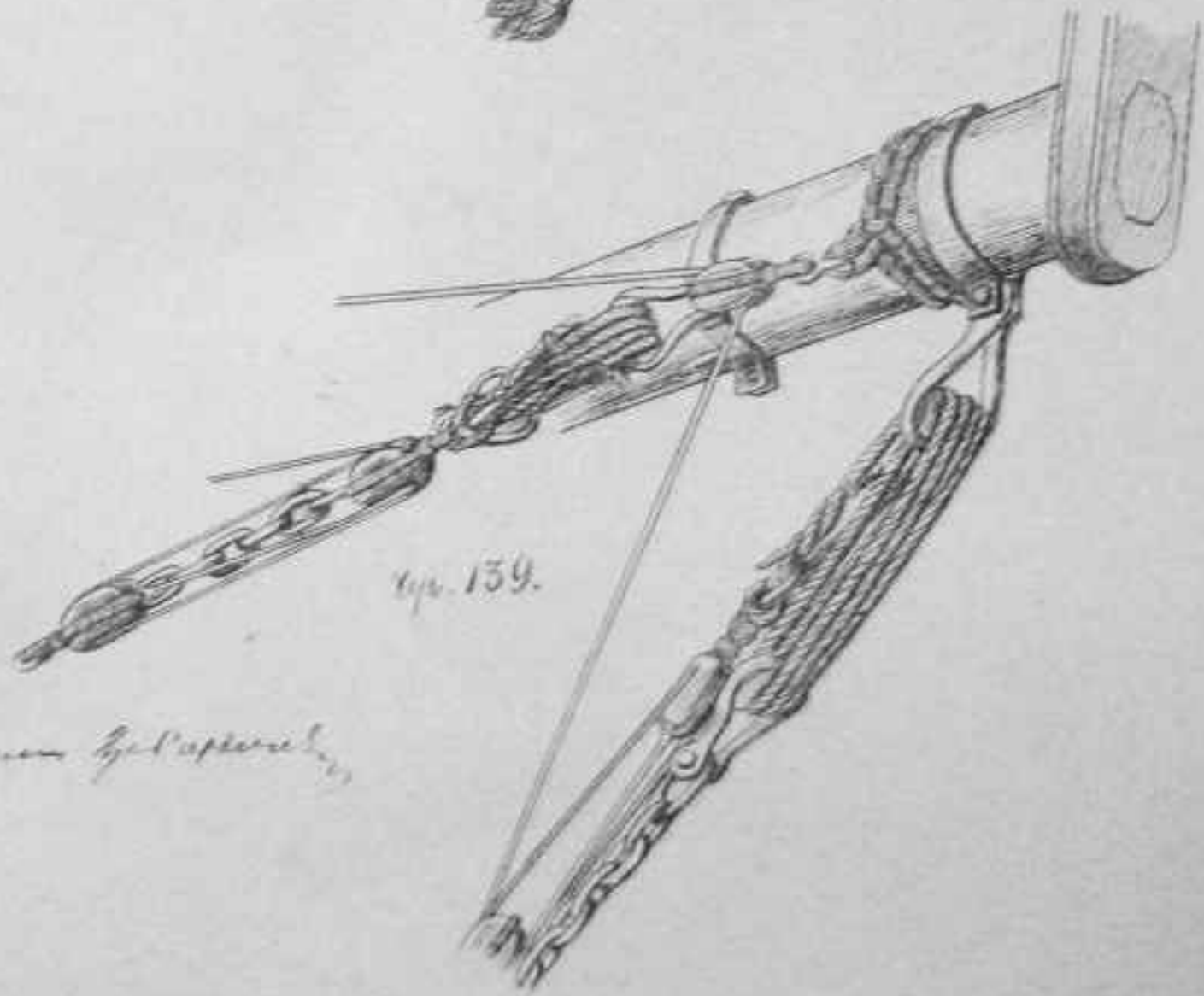
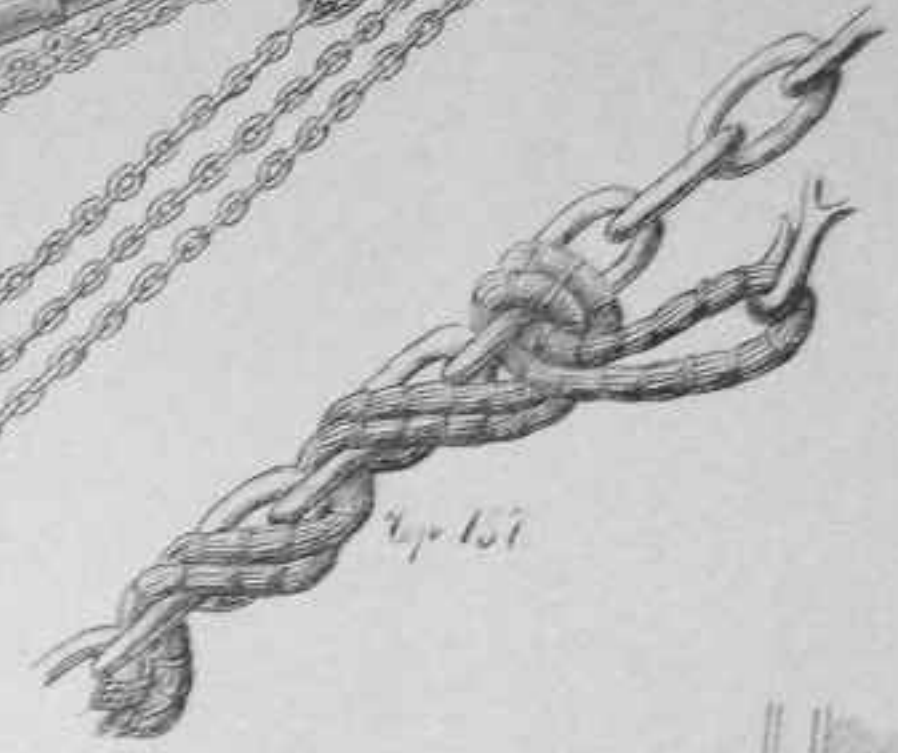
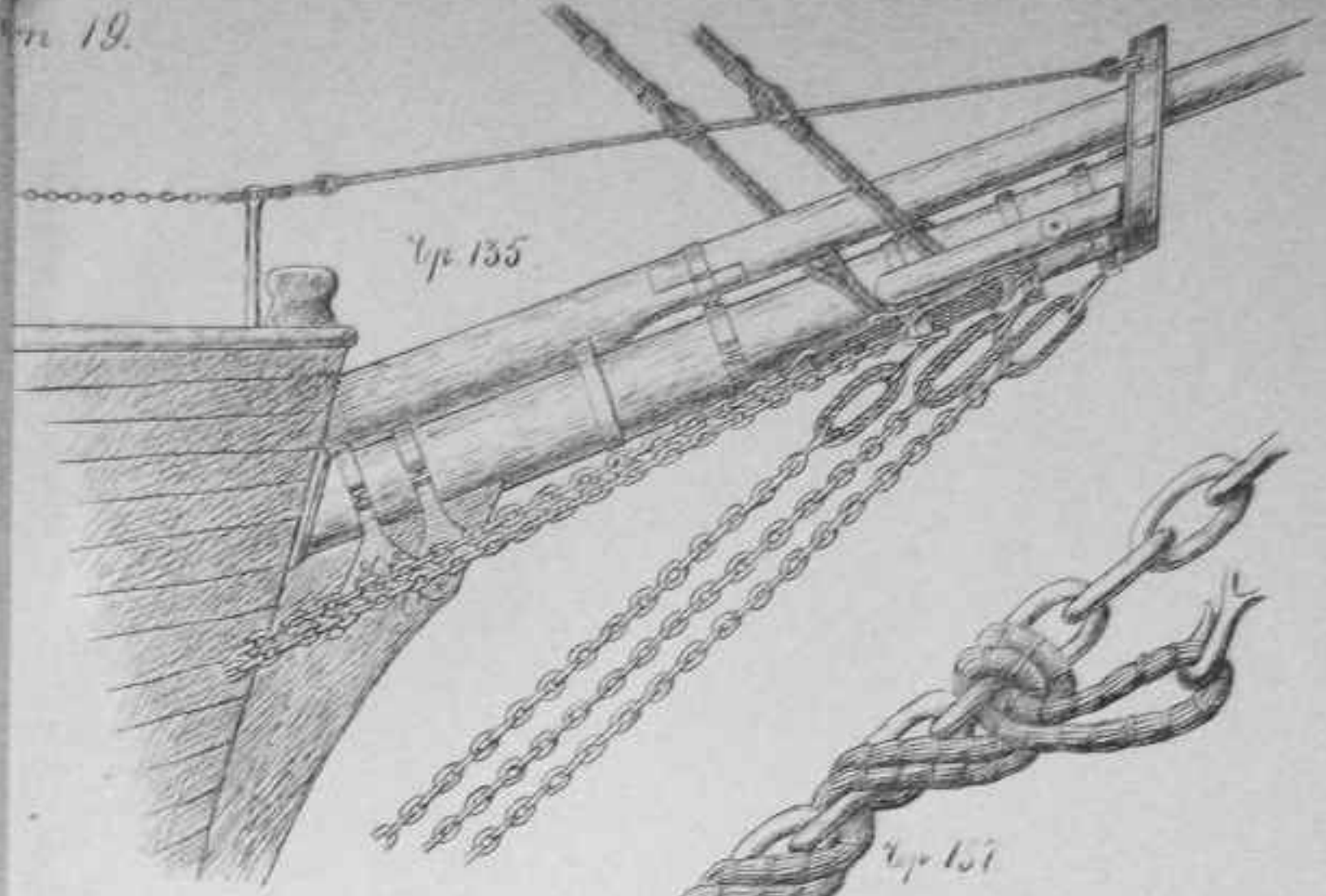
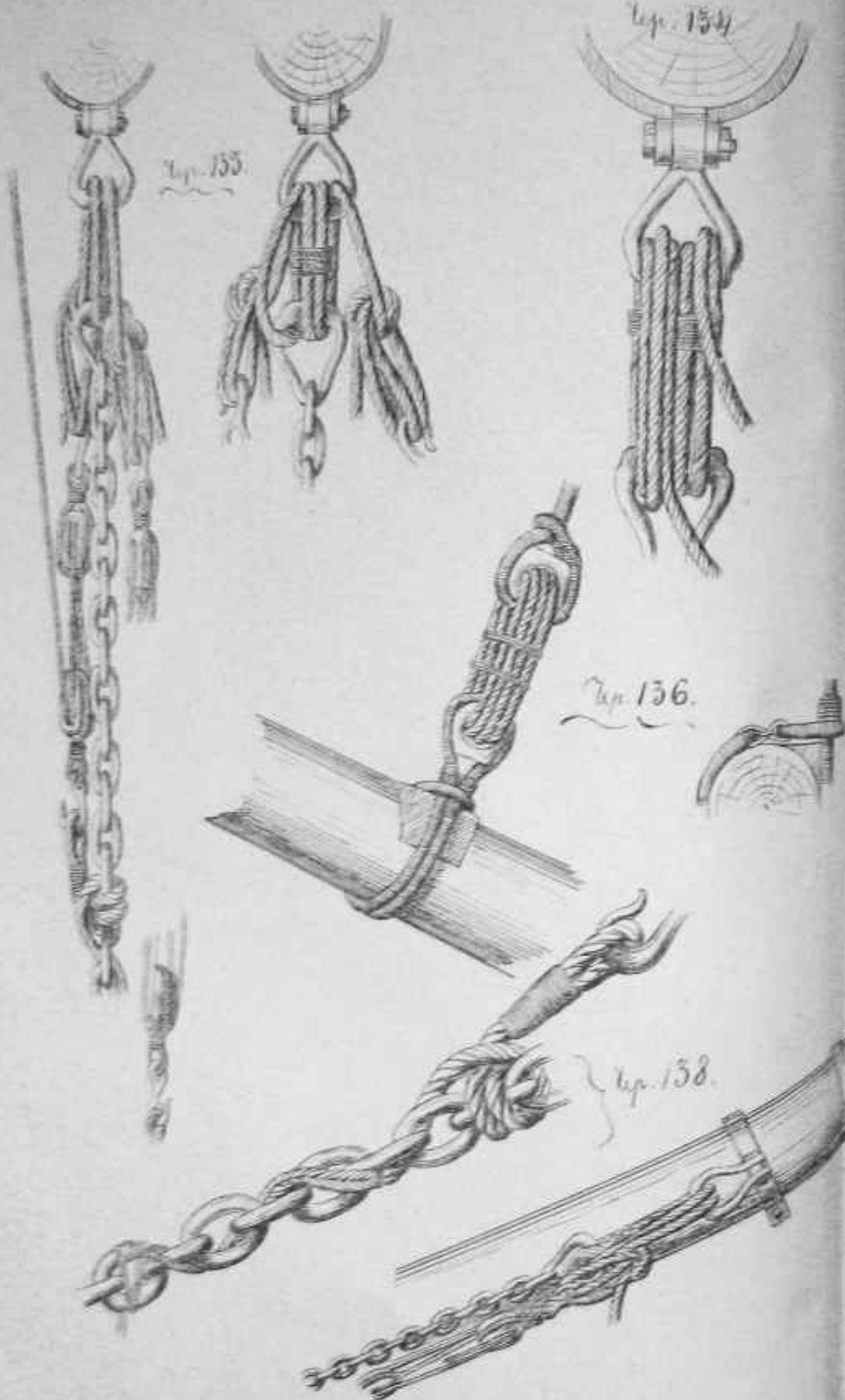

Canon by the stern

Aug. 20.

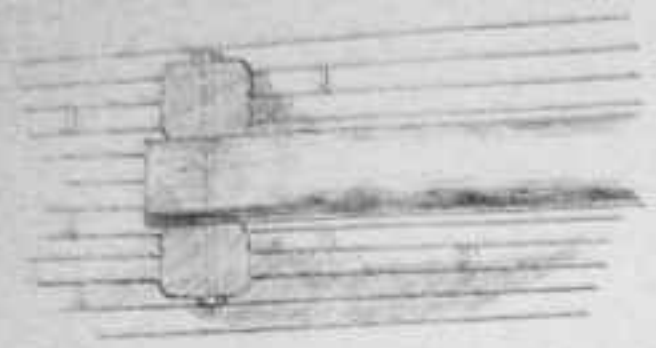

Fig. 140

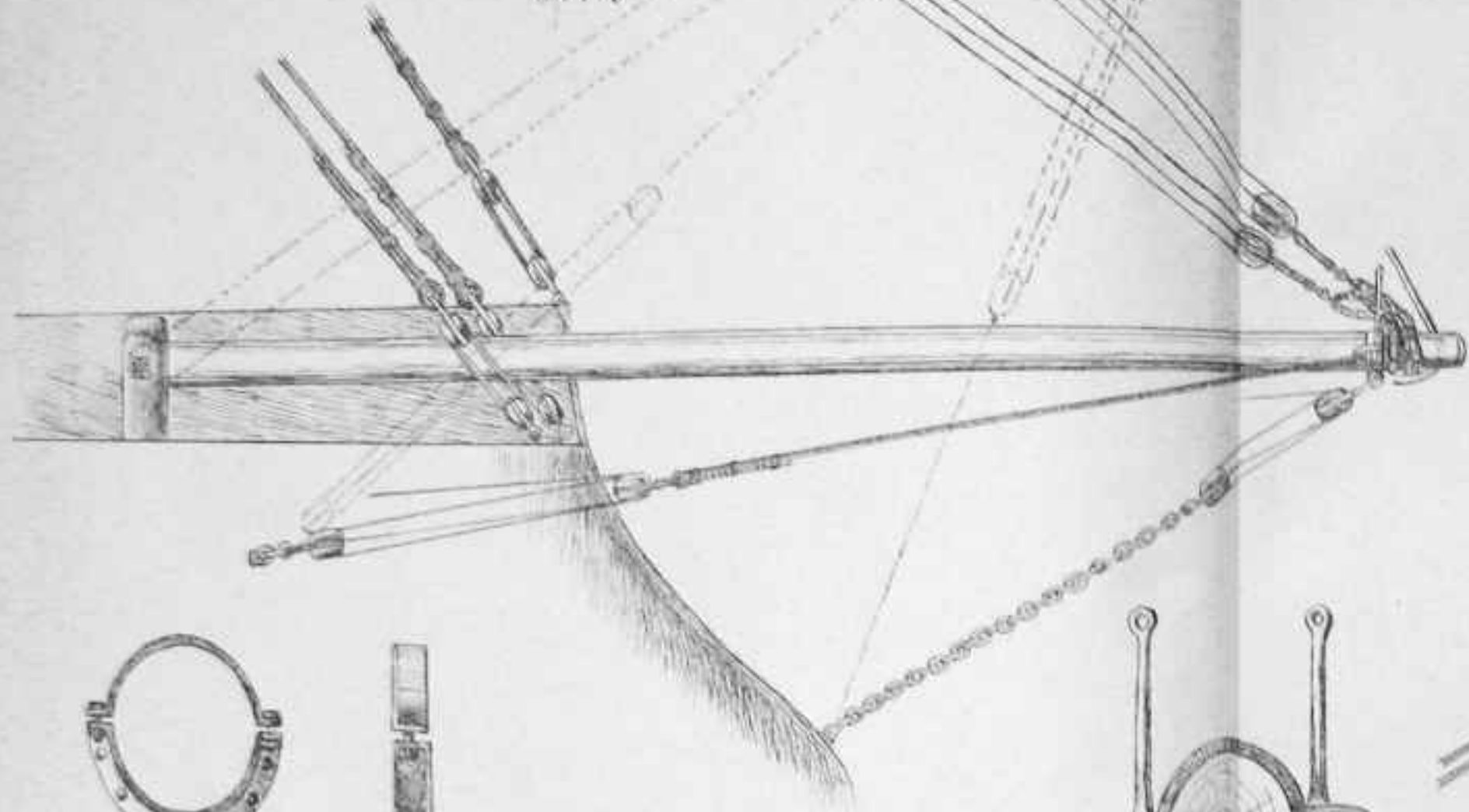

Fig. 141

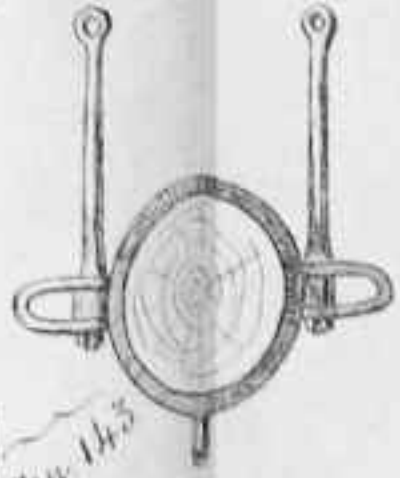

Fig. 143



Fig. 142

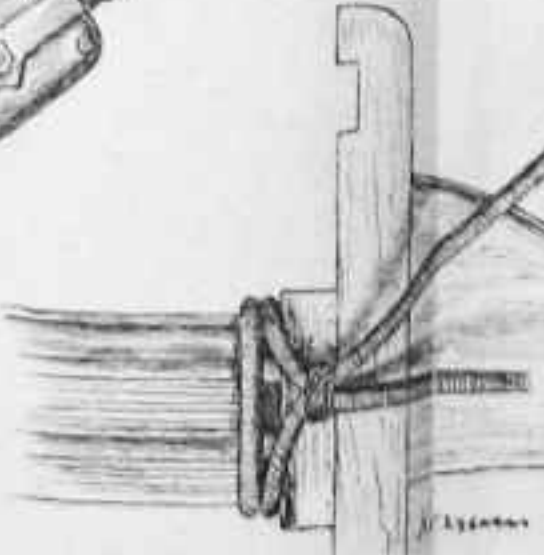
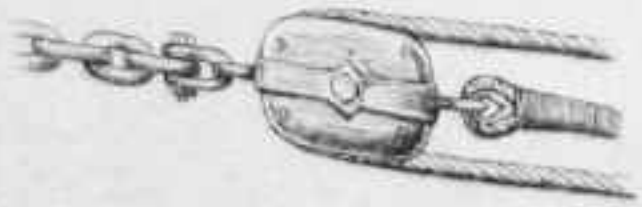

Fig. 144

Aug. 20. Capt. R.

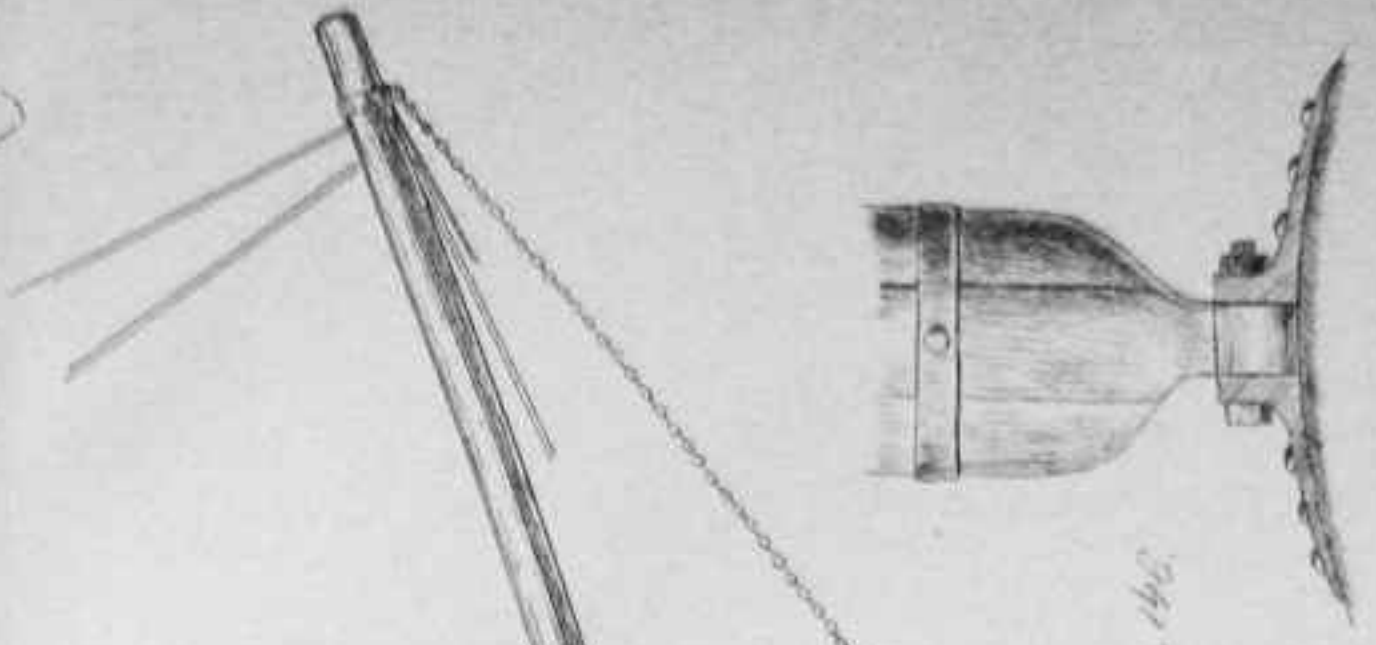

Fig. 145

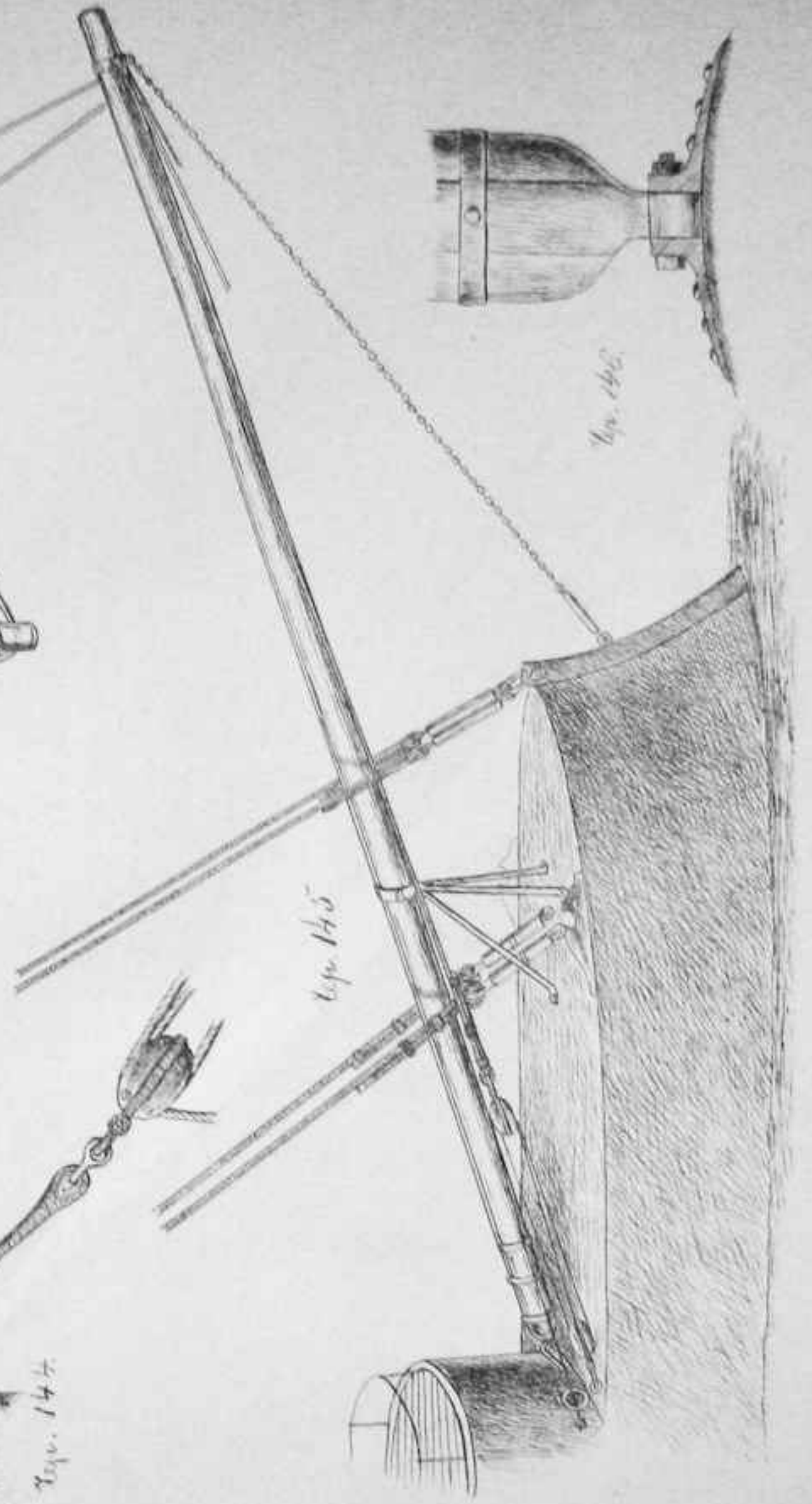

Fig. 145

Fig. 21.

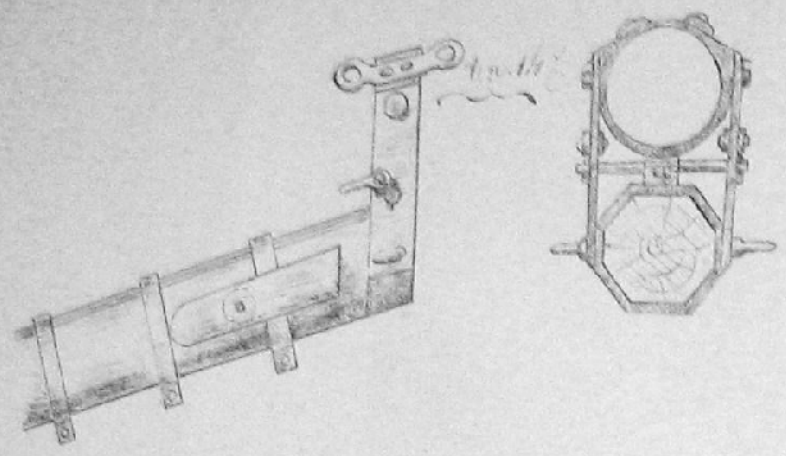

Fig. 147.

Fig. 148.

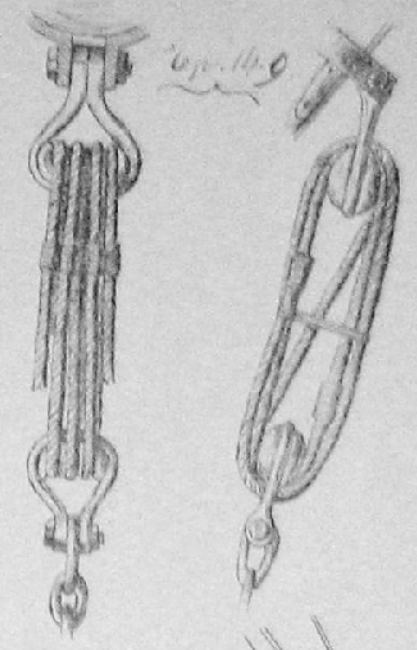
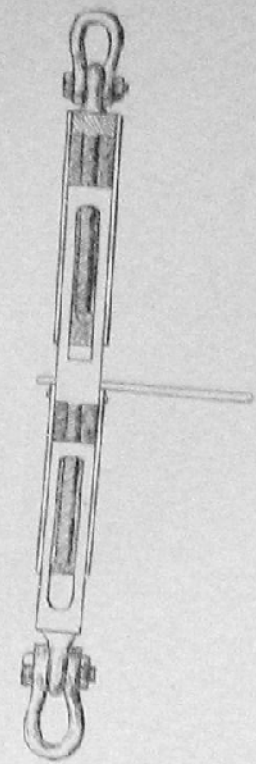
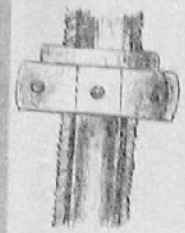
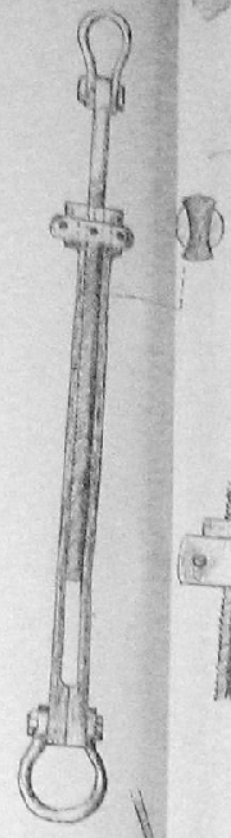

Fig. 149.

Fig. 151.

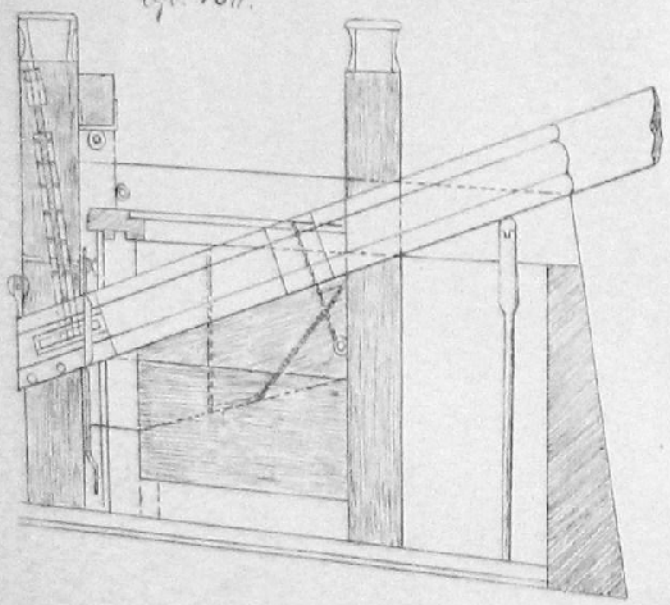

Fig. 152.

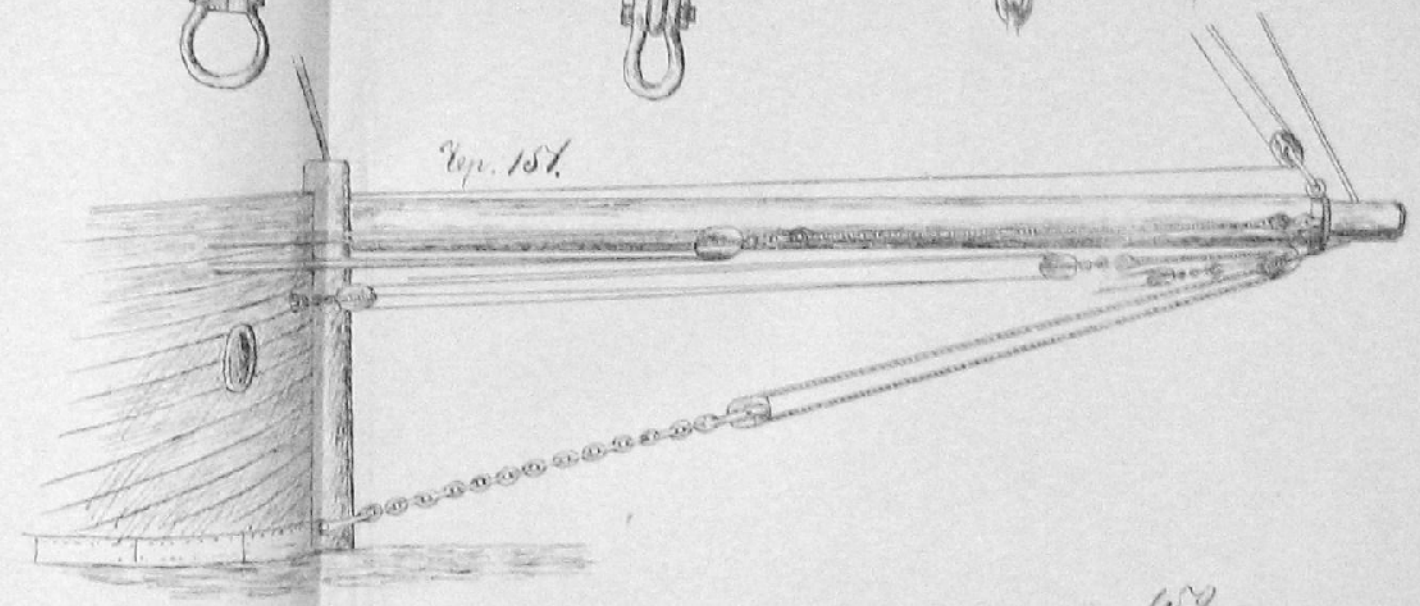
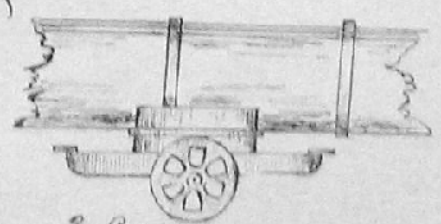
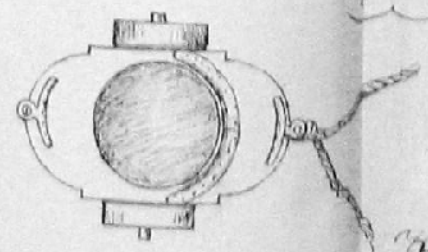
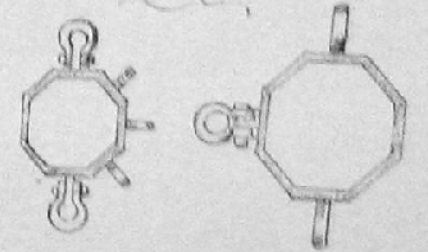

Fig. 153.



Wagon for Captains

Fig. 154.



Jan. 22.

Fig. 157.

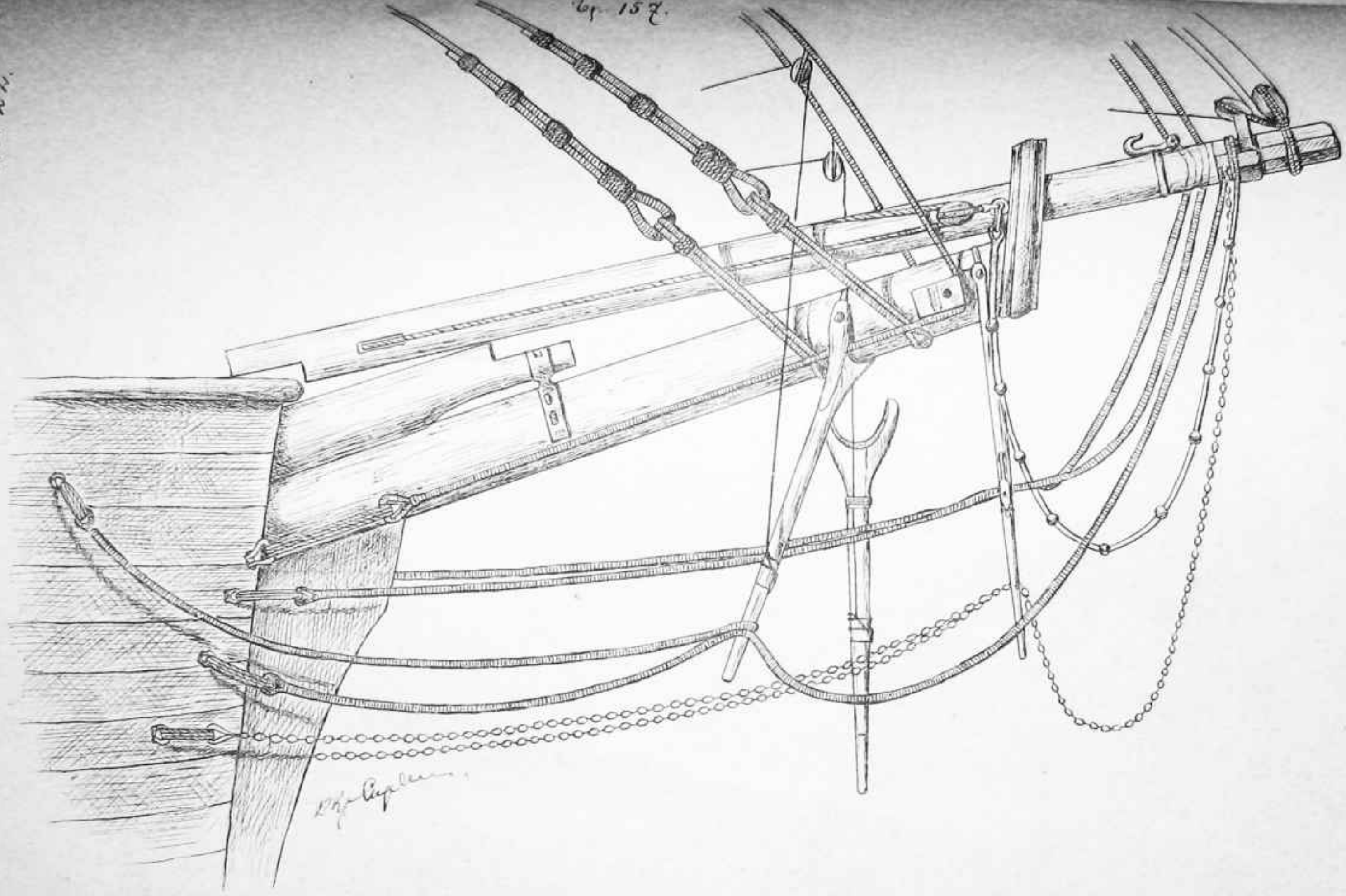

Wm. Beaman

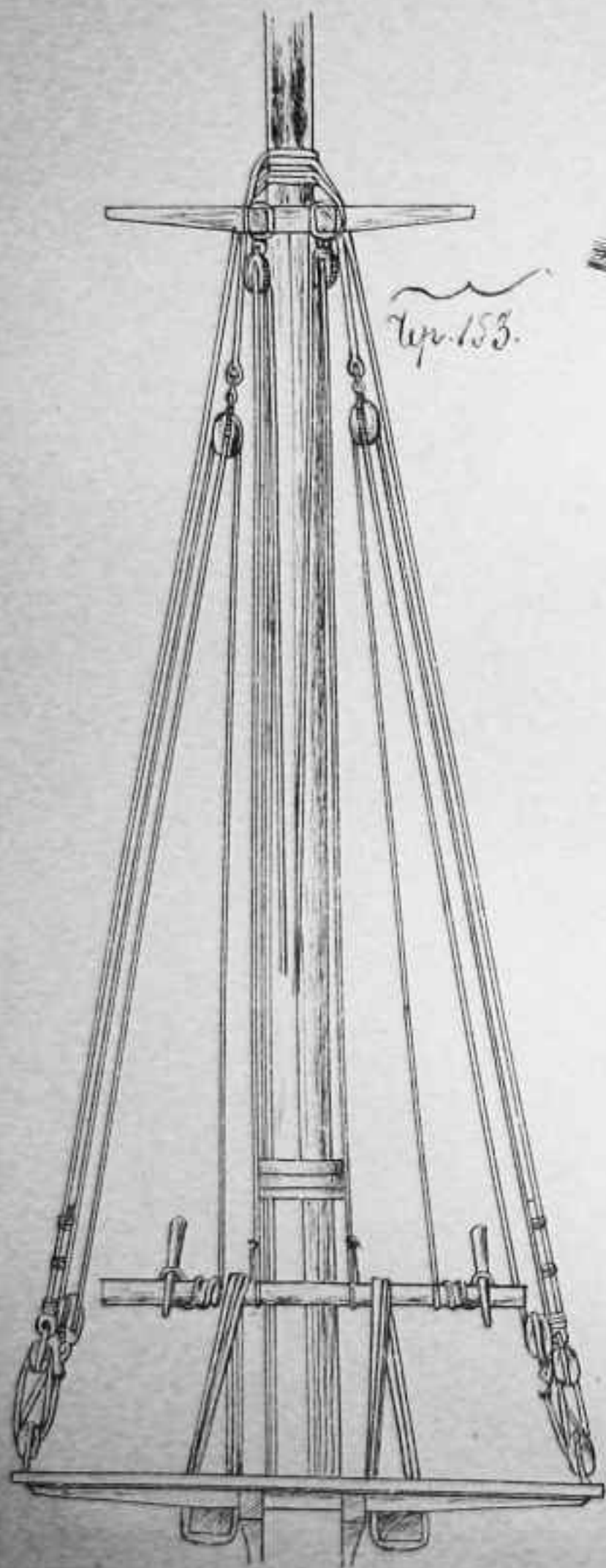

Fig. 153.



Fig. 154.

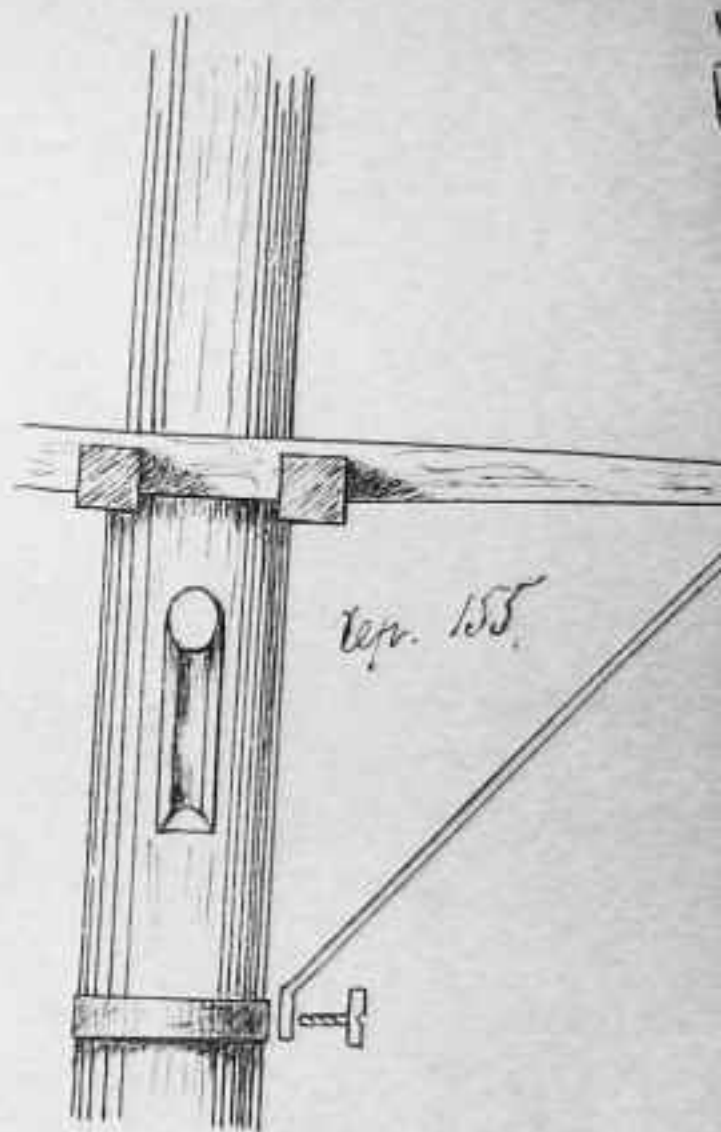
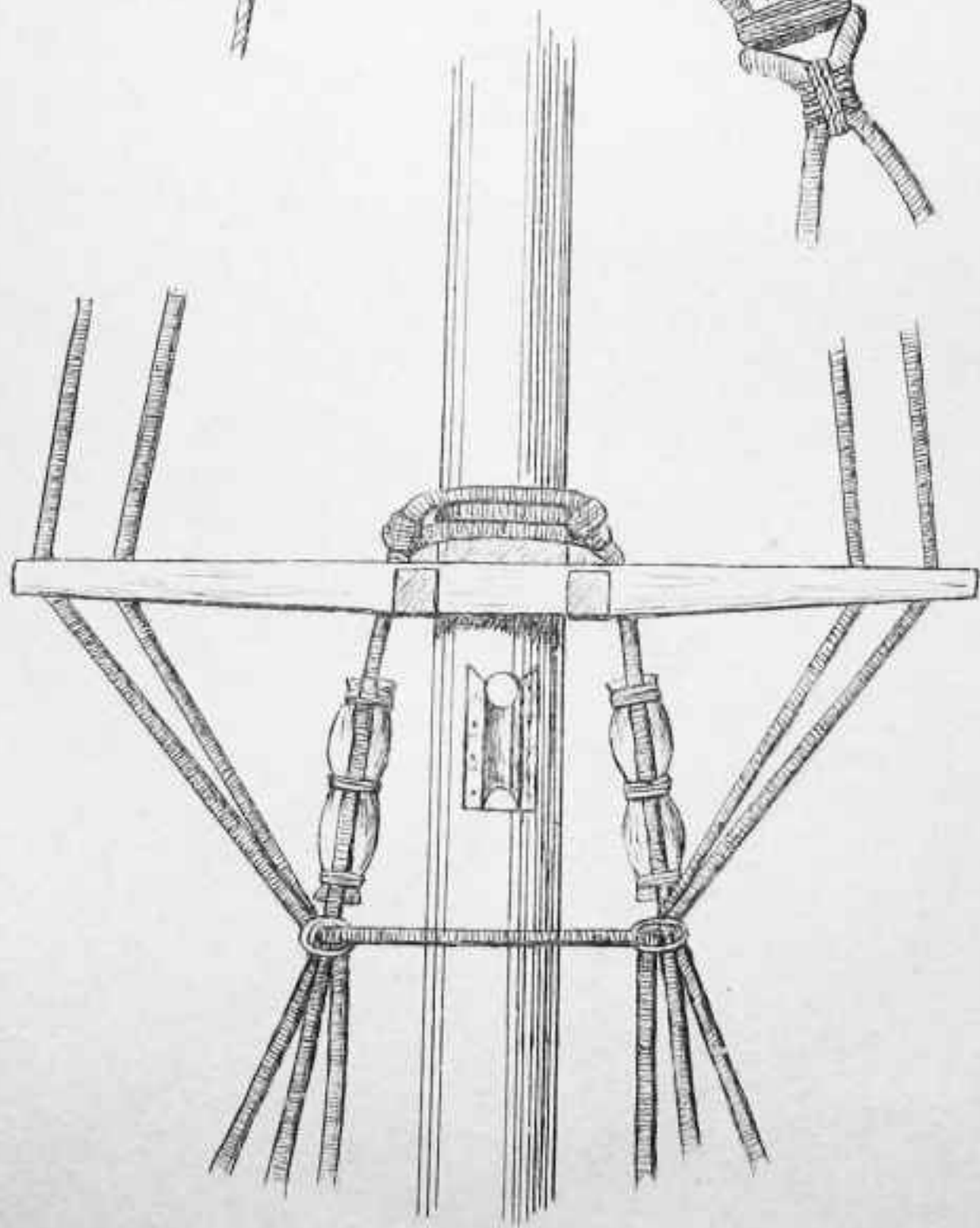
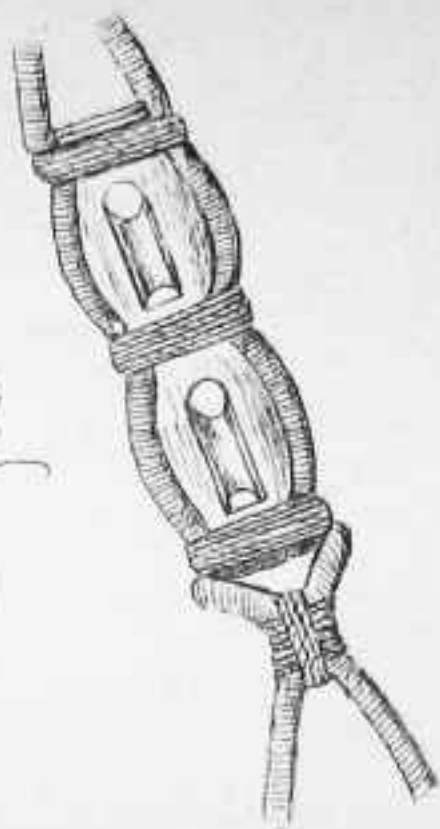

Fig. 155.

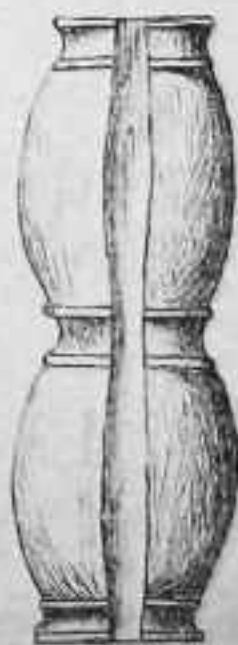

Fig. 156.



Aug. 23.

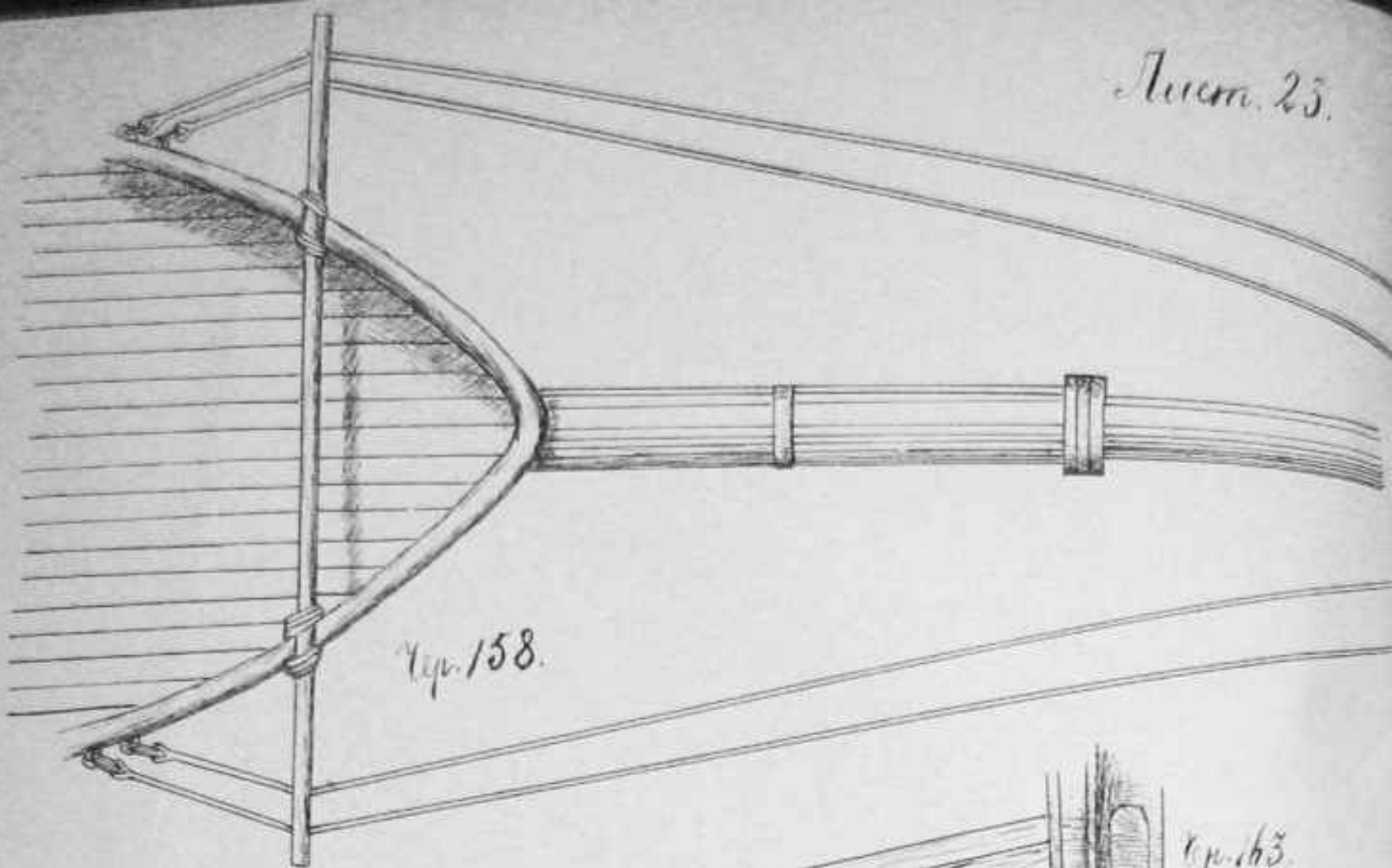

Fig. 158.

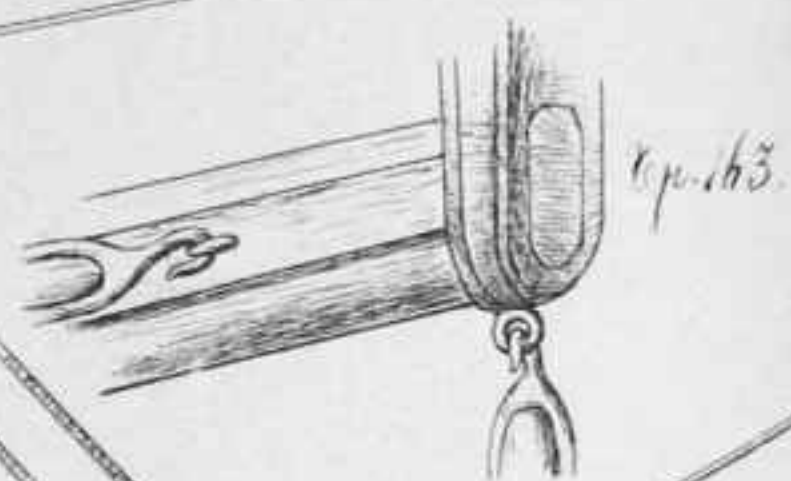

Fig. 163.

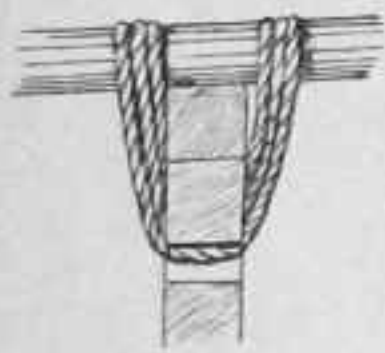

Fig. 170.

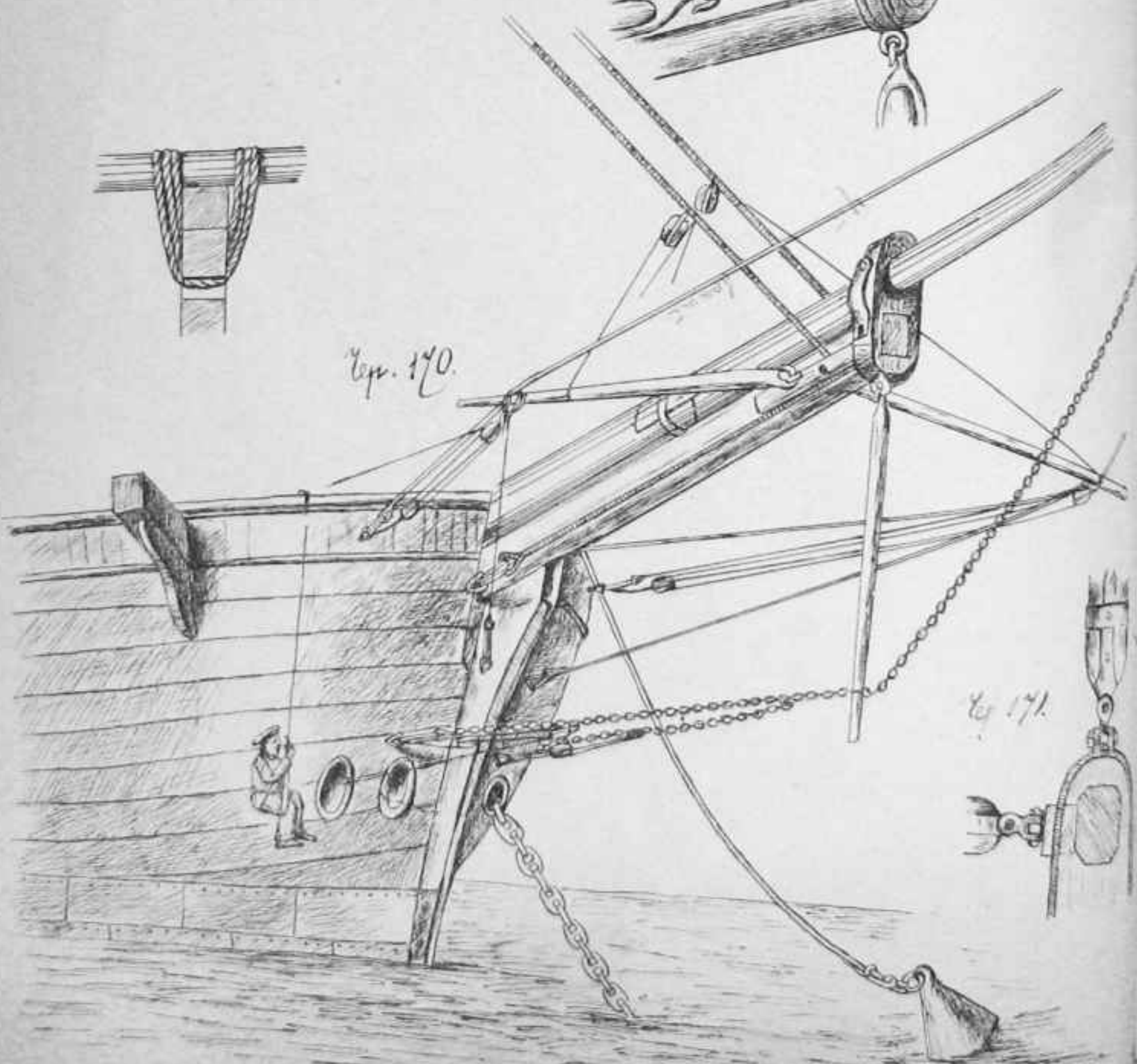

Fig. 171.





Fig. 159.

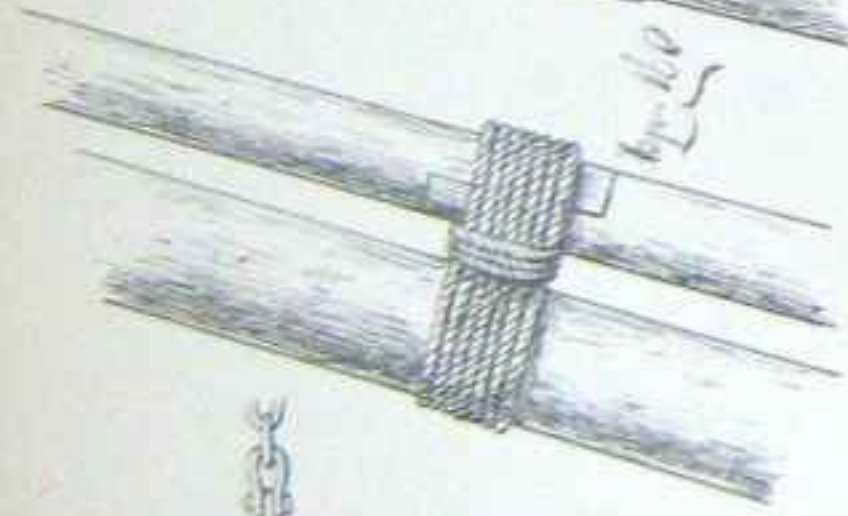

Fig. 160.

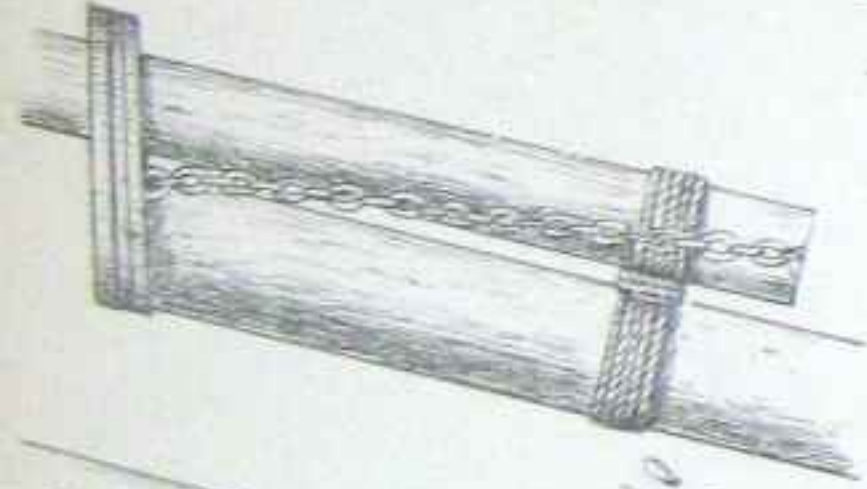

Fig. 161.

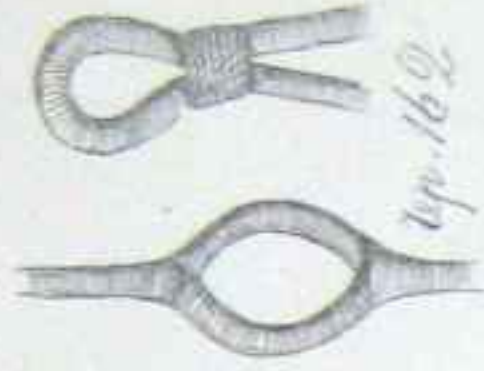
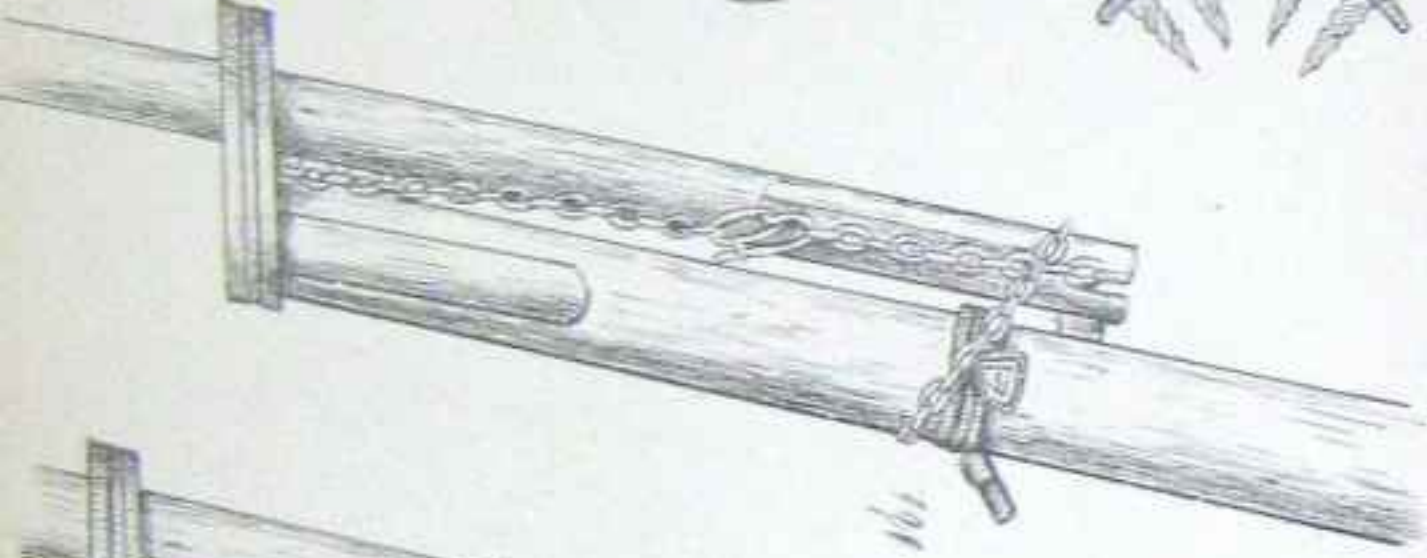

Fig. 162.



Fig. 163.



Fig. 169.



Fig. 165.

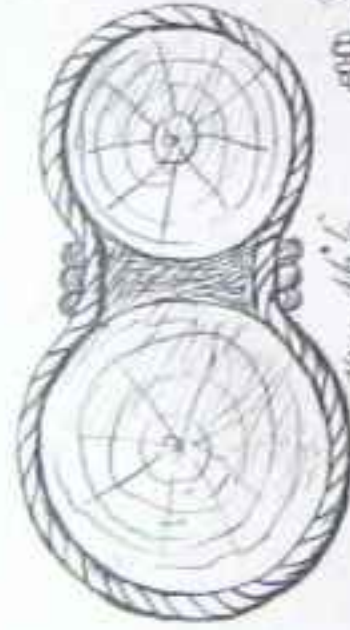

Fig. 166.



Fig. 167.

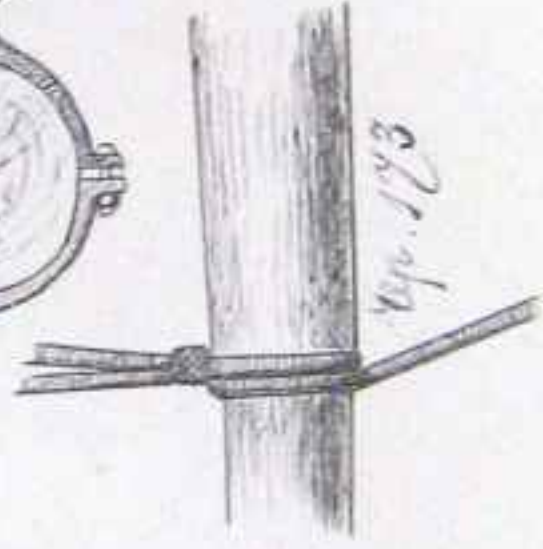

Fig. 173.

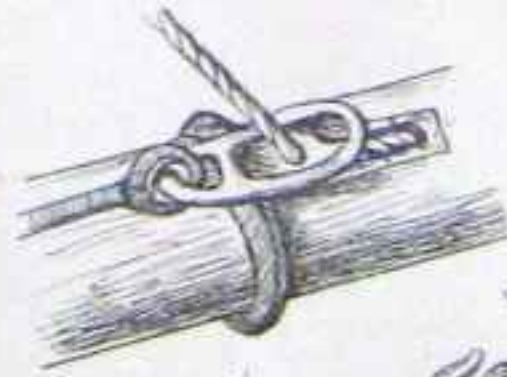

Fig. 172.

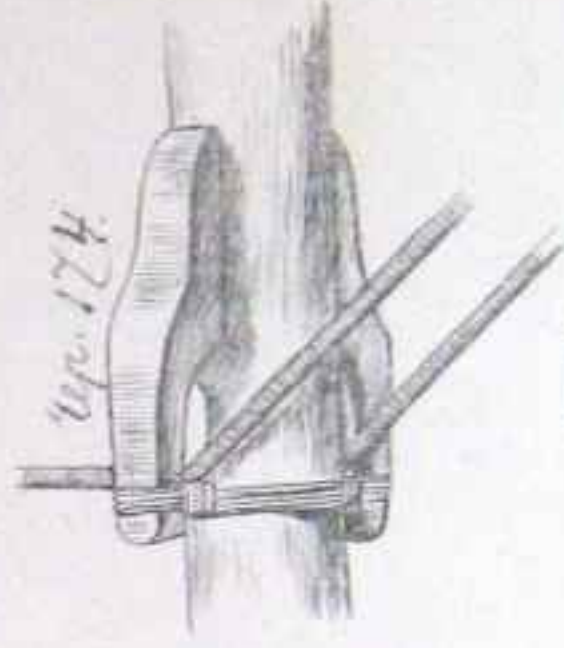

Fig. 174.

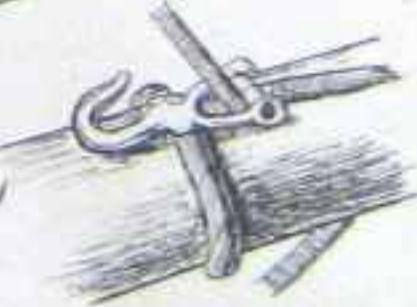

Fig. 176.

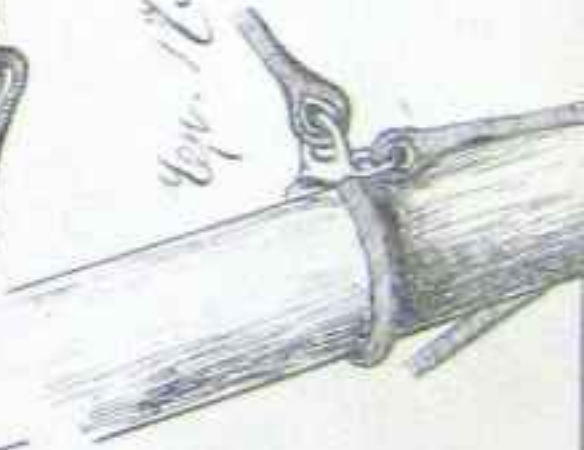

Fig. 175.

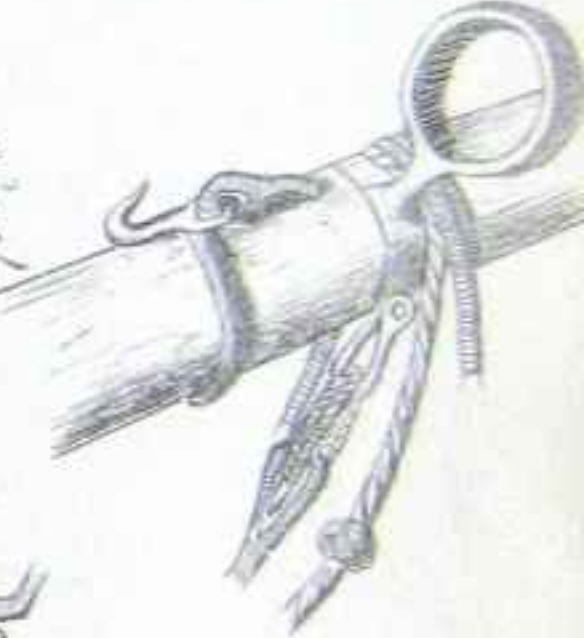
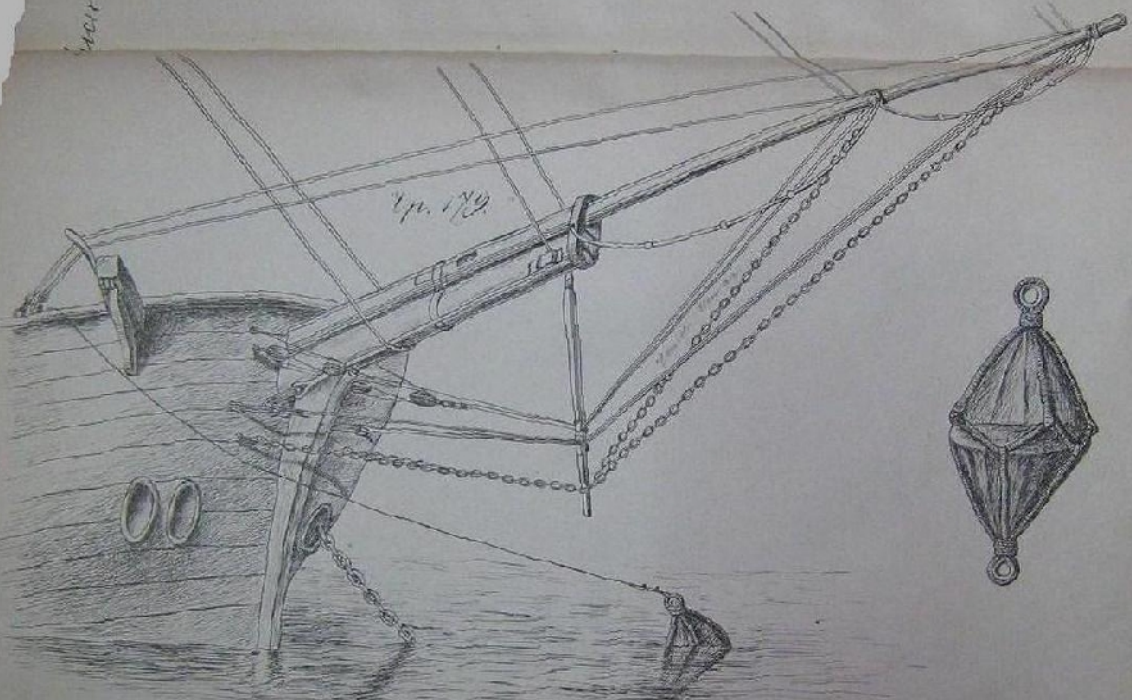

Fig. 177.

1401. 24

Fig. 179



View of the stern

For the
rigging
of the
masts
of the
ship

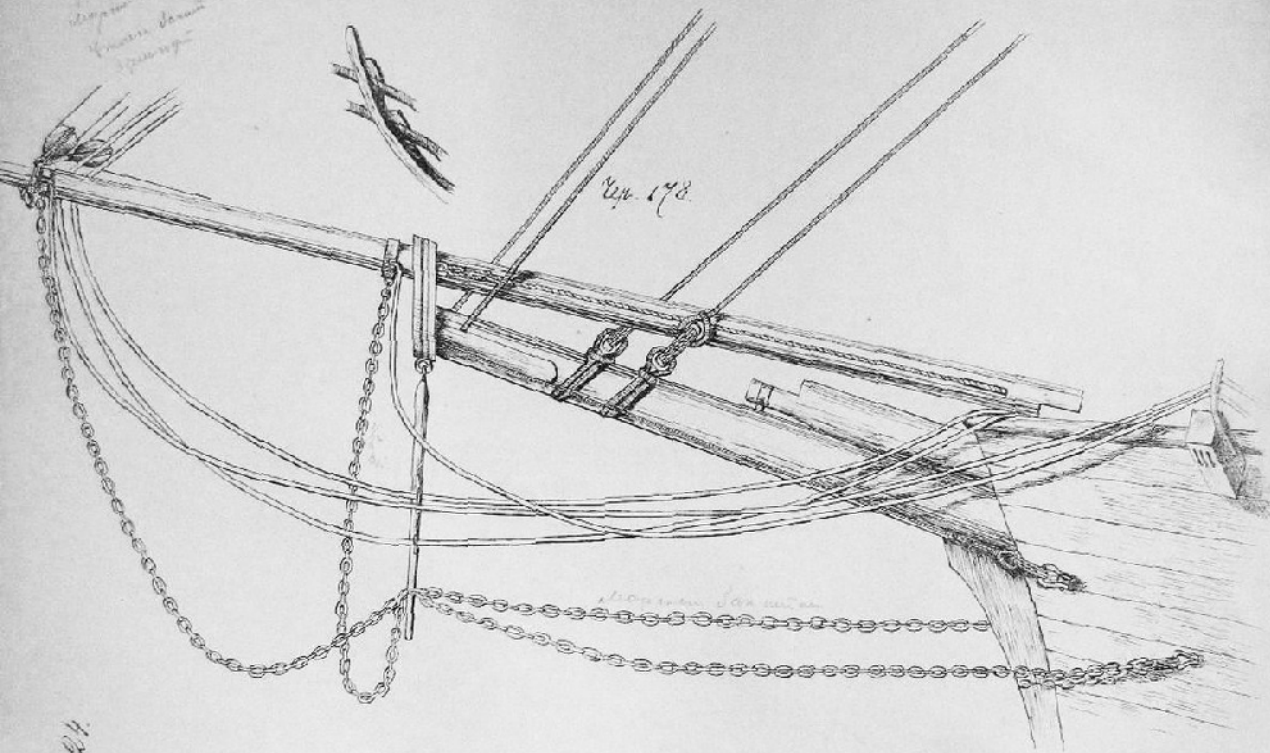

24 178

for the
masts

1. 24

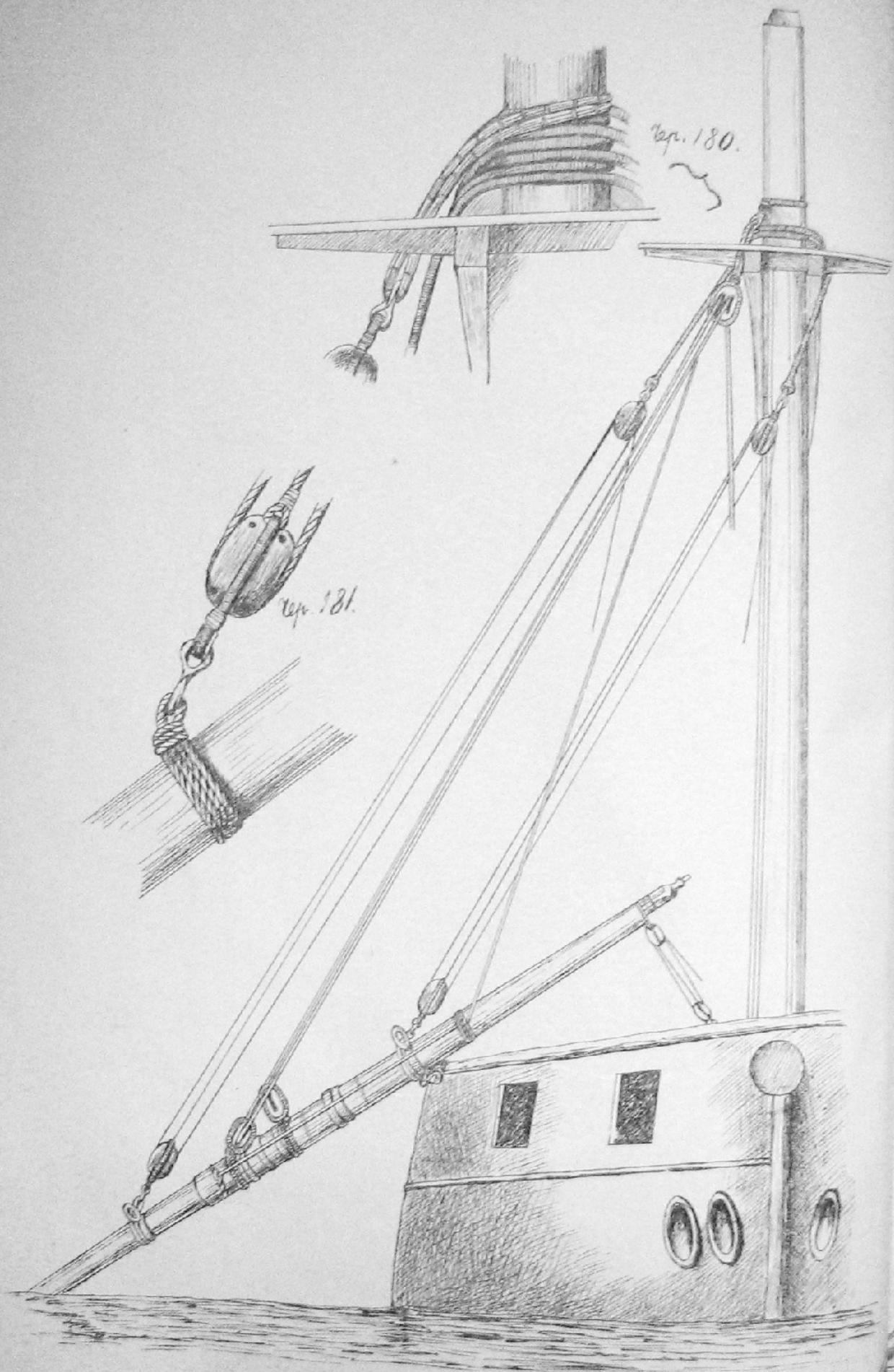

Fig. 180.

Fig. 181.

Kau G. L. G.

Aug. 25.

Fig. 163.

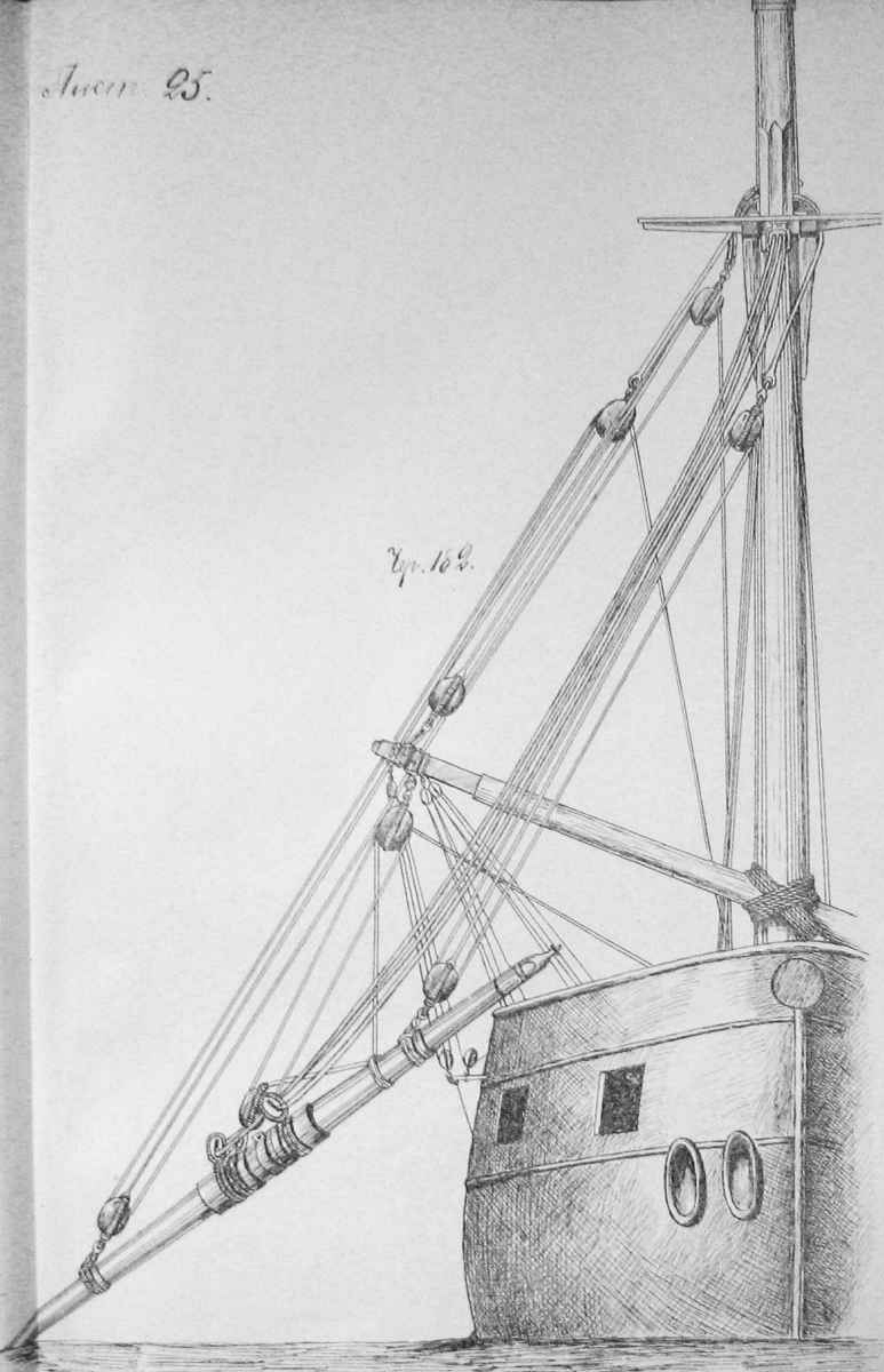
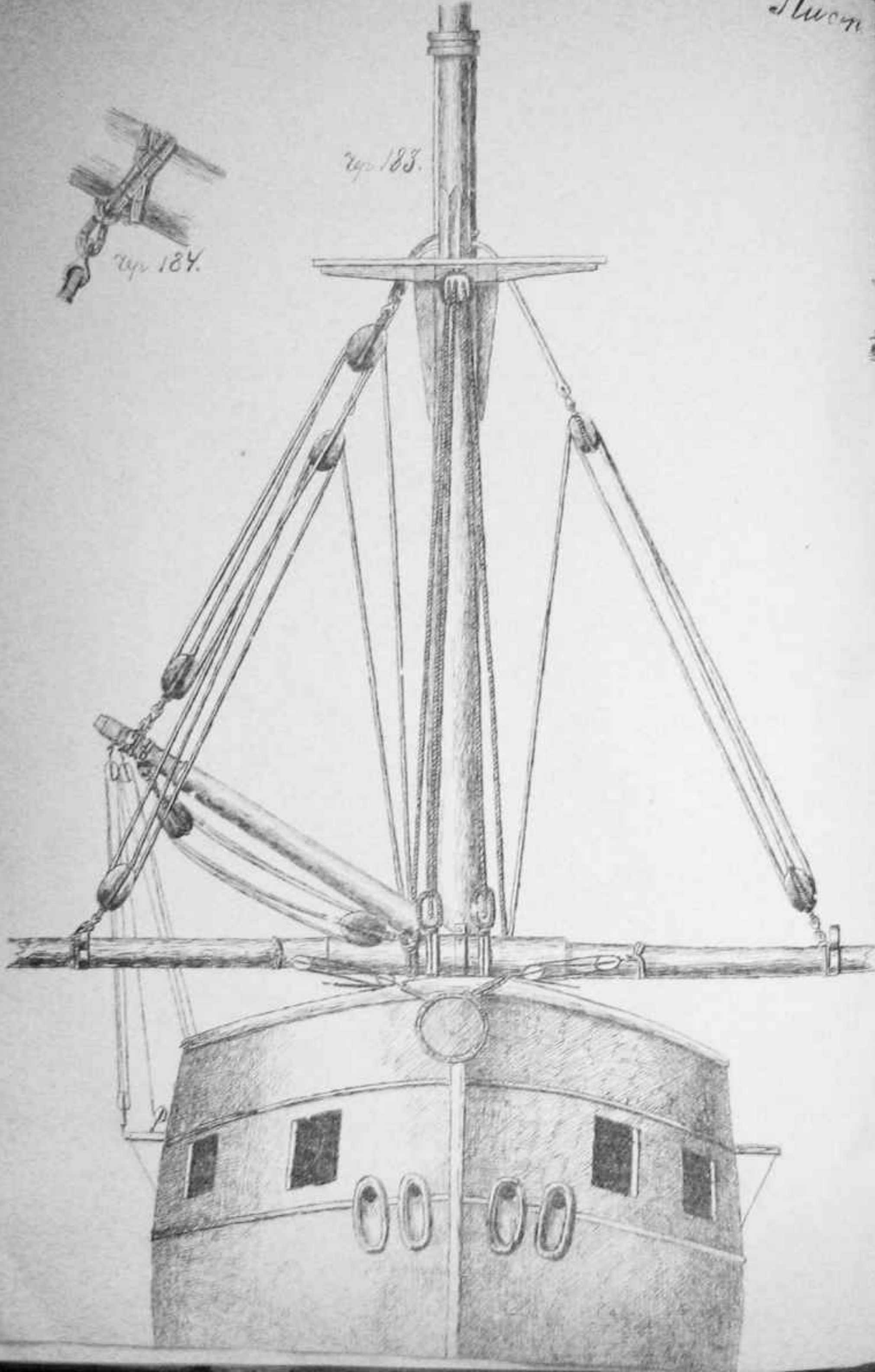

Fig 183.

Fig 184.



Armen. 27.

Fig. 188

Fig. 189

Fig. 190



Fig. 191

Fig. 192

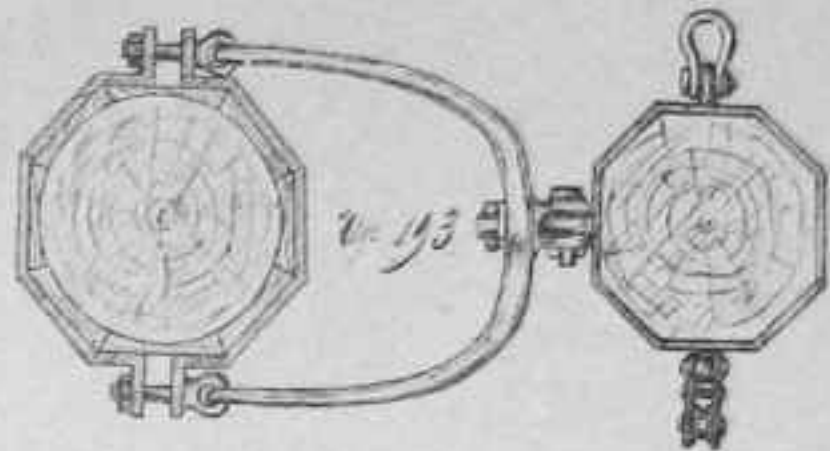
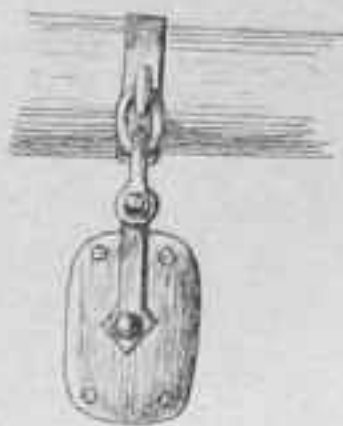
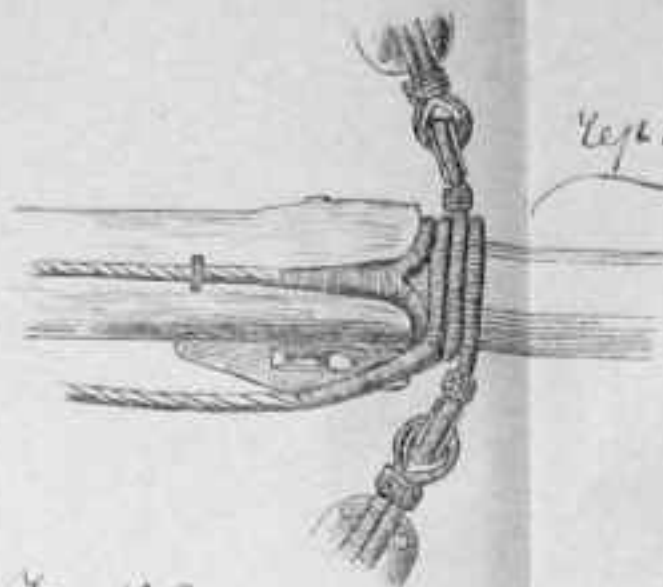
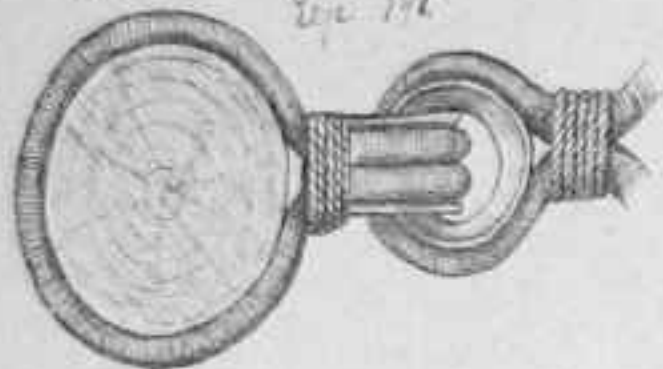

Fig. 195

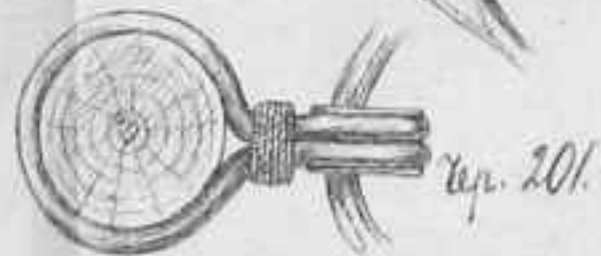
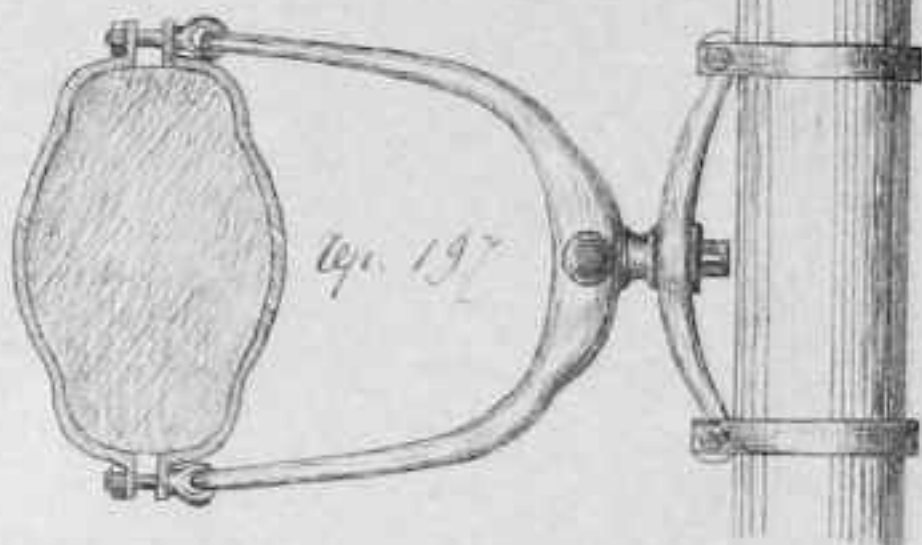
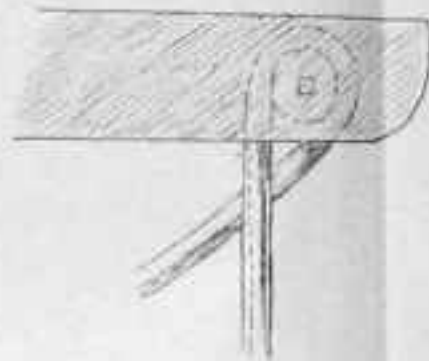
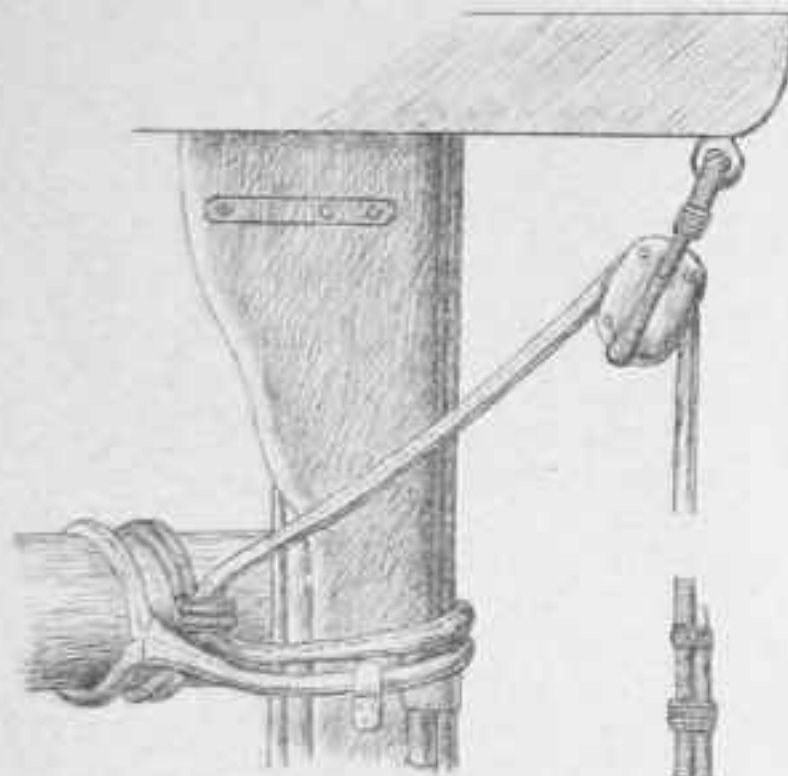

Fig. 201

Fig. 202



Fig. 200

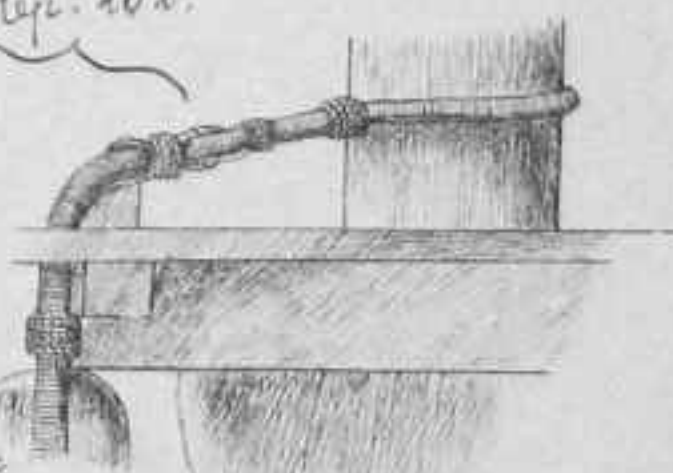
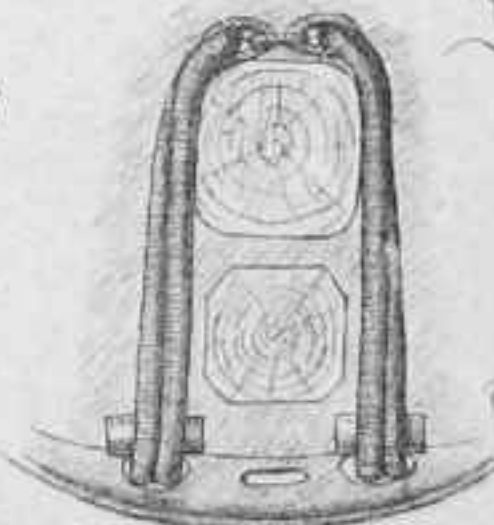

Fig. 199

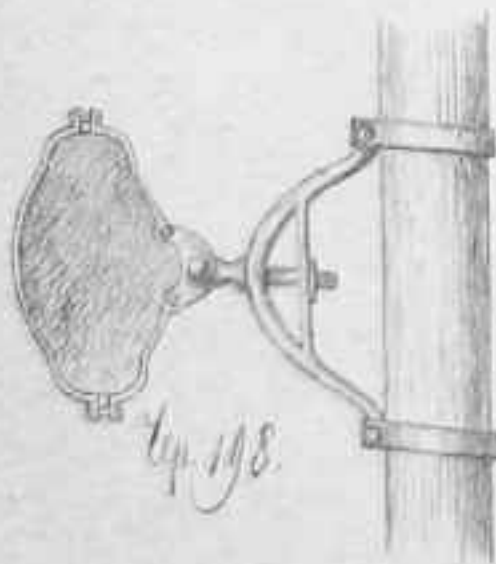
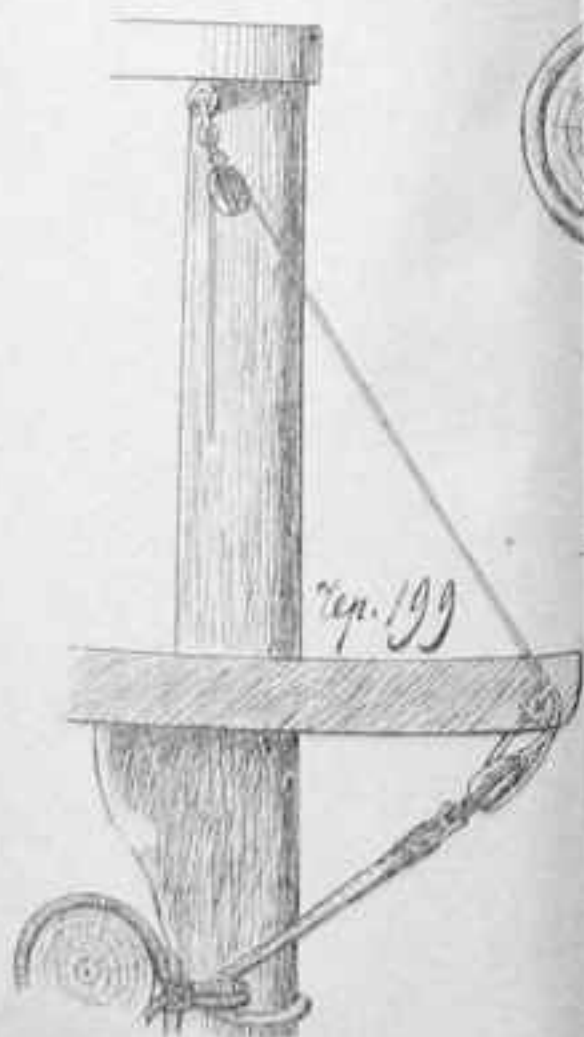

Fig. 198



Fig. 203



Van der Capellen

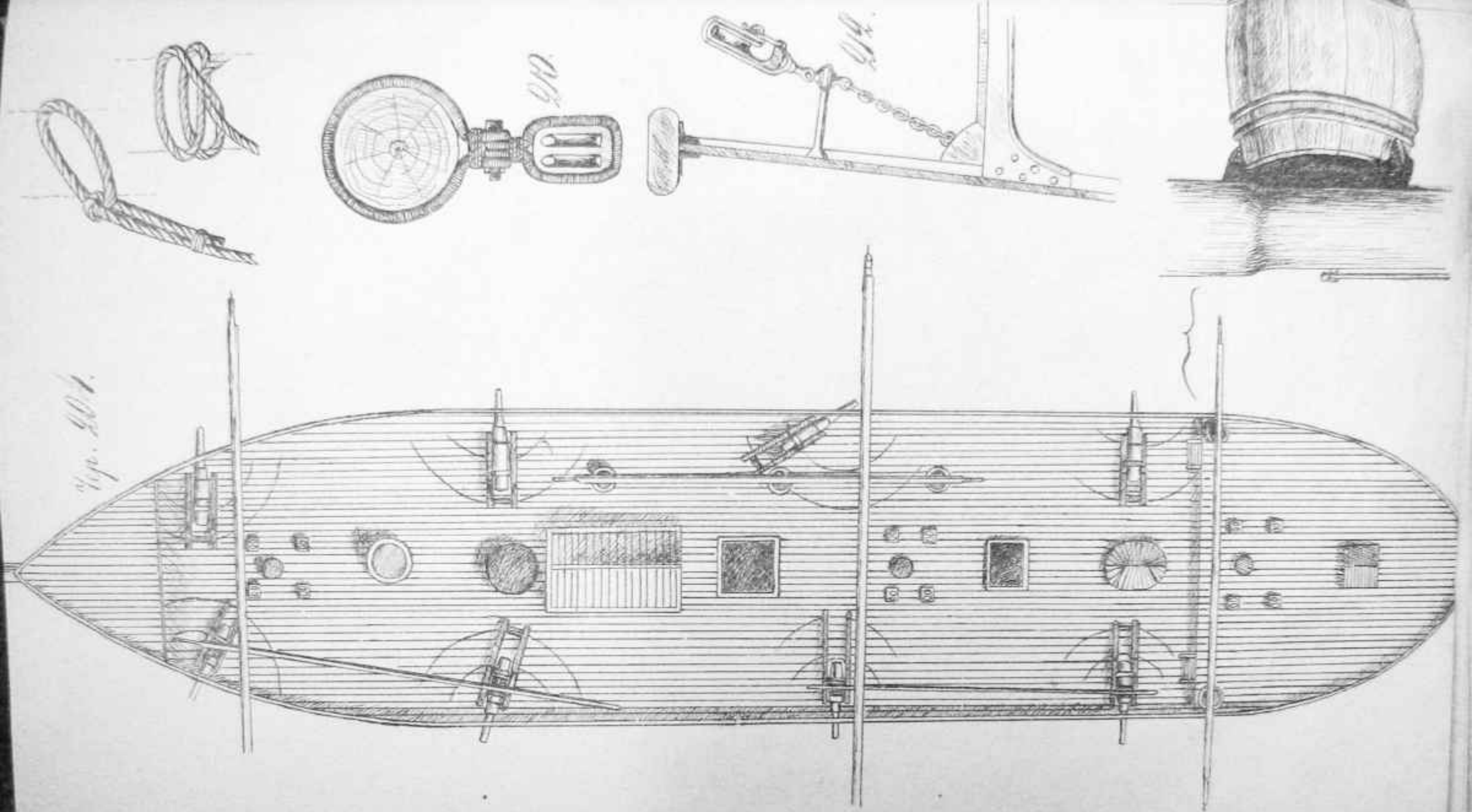

404

405

406

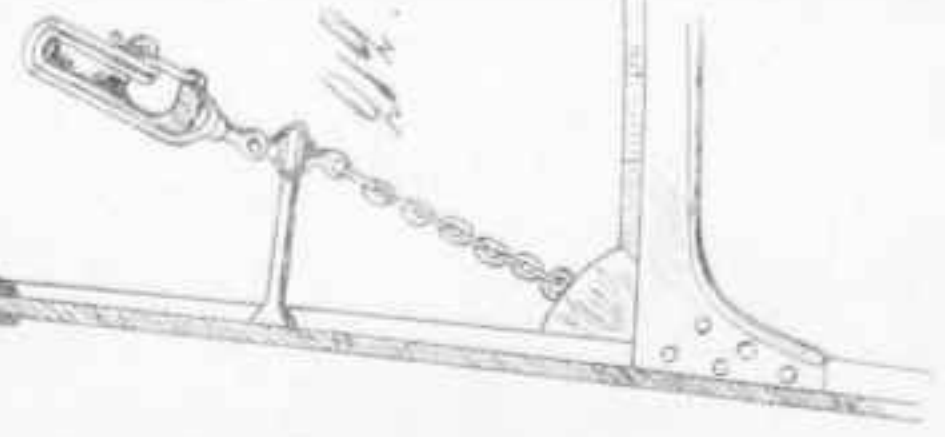
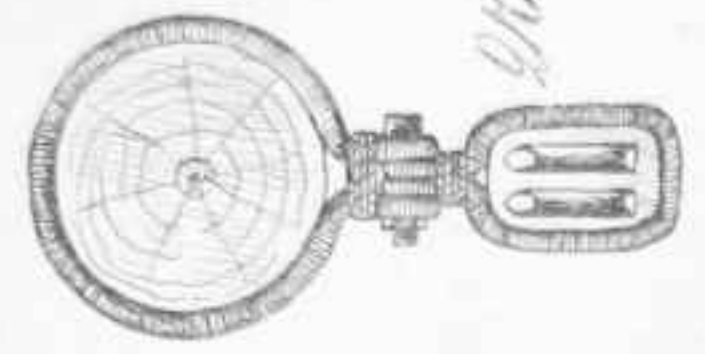
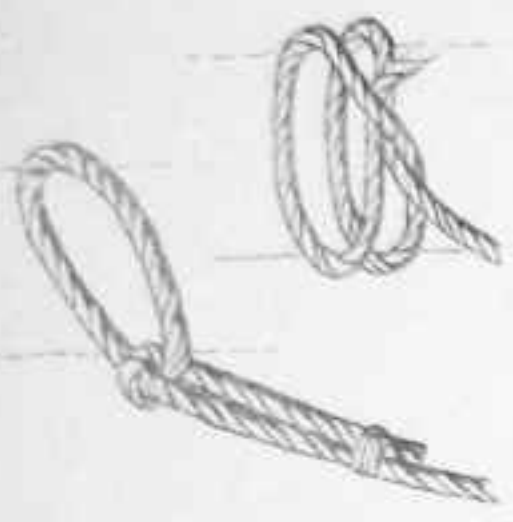

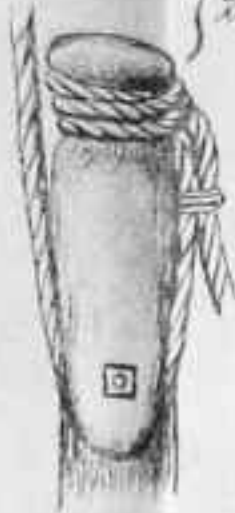
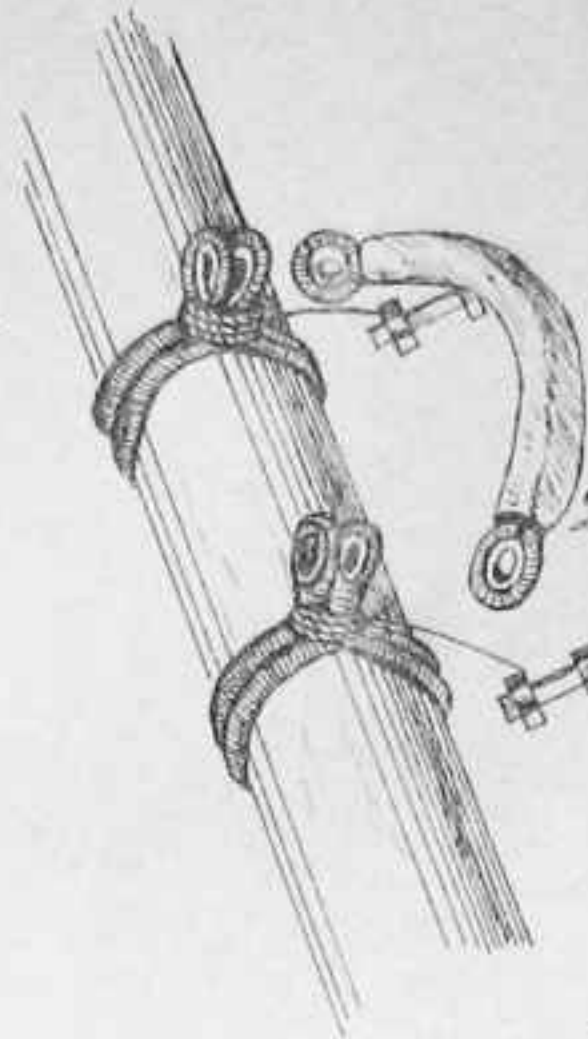
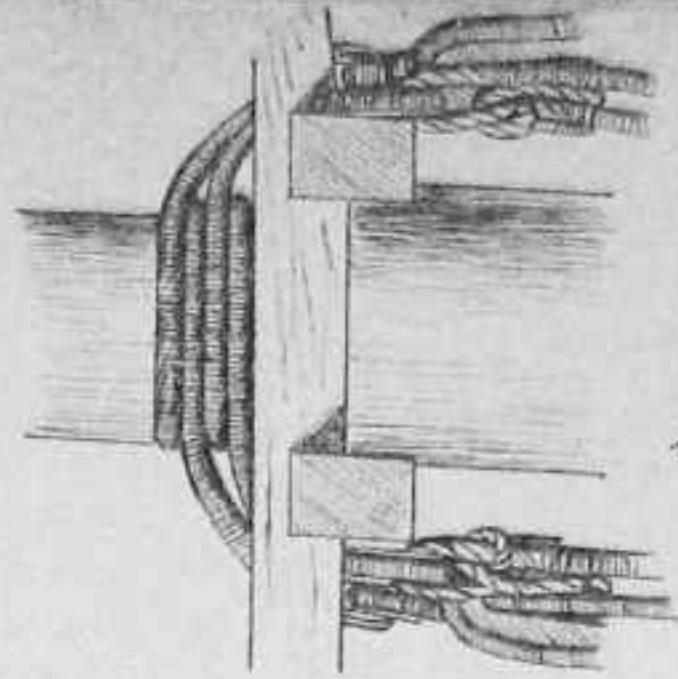

Fig. 205



206



207



210

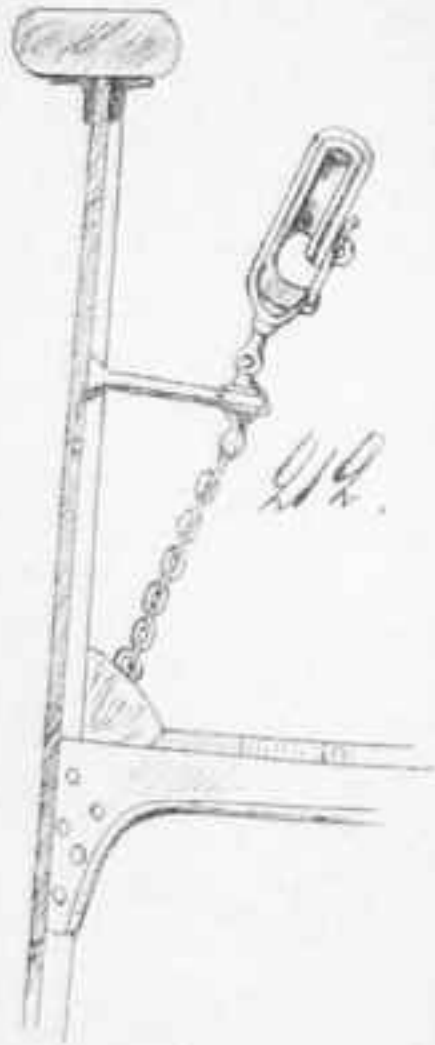

212

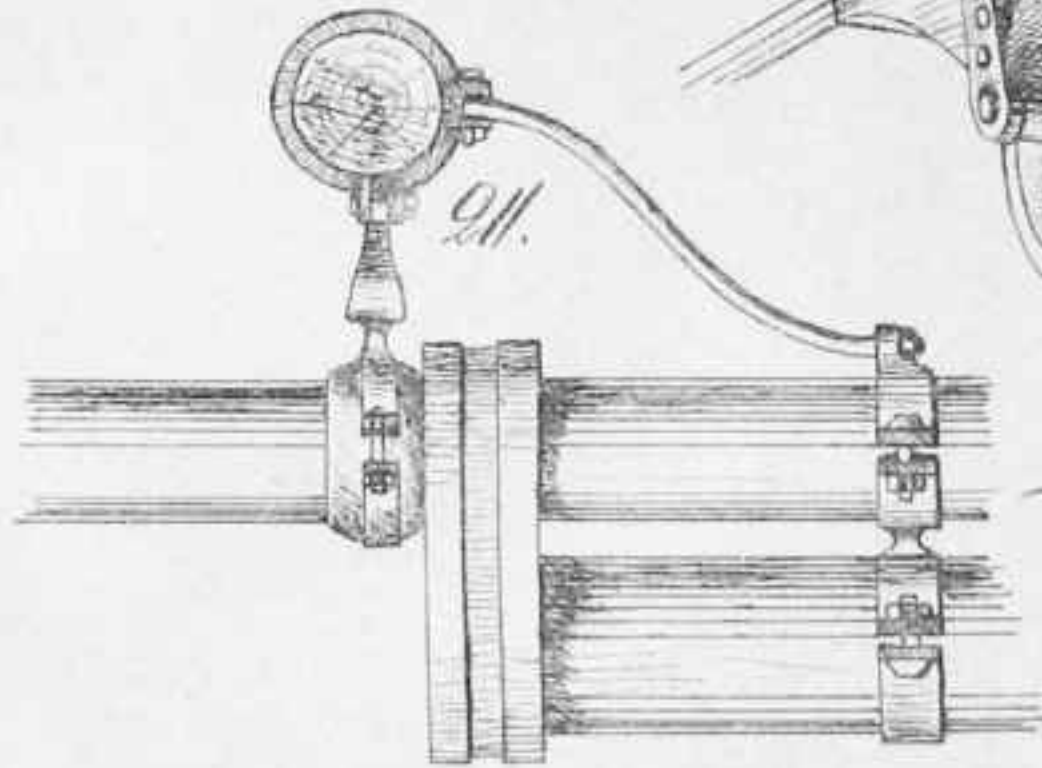

211

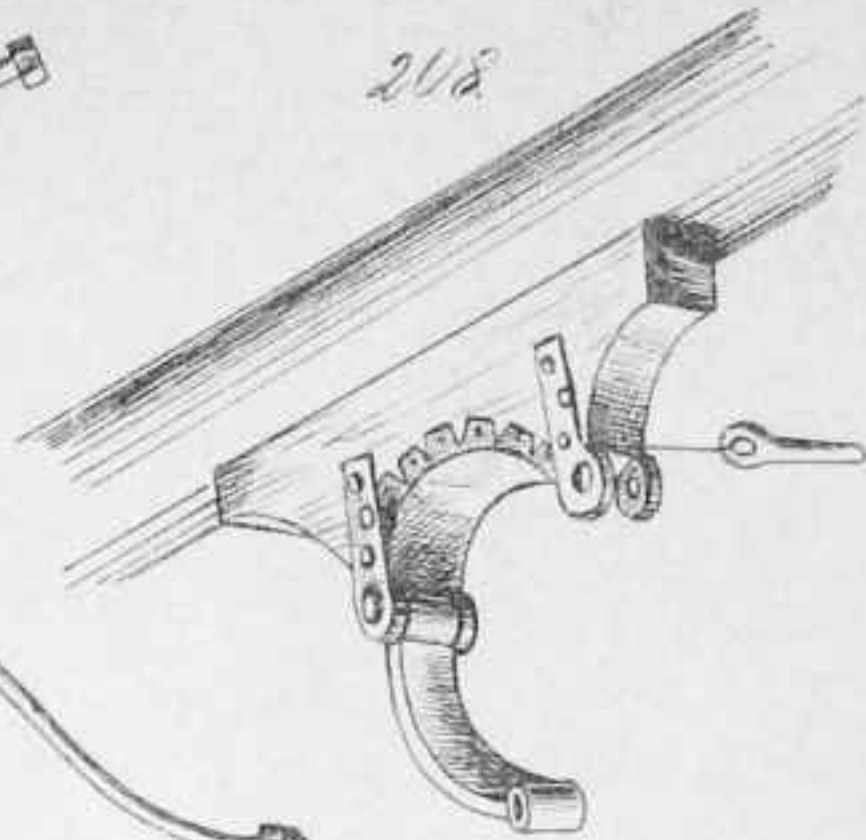

218



209

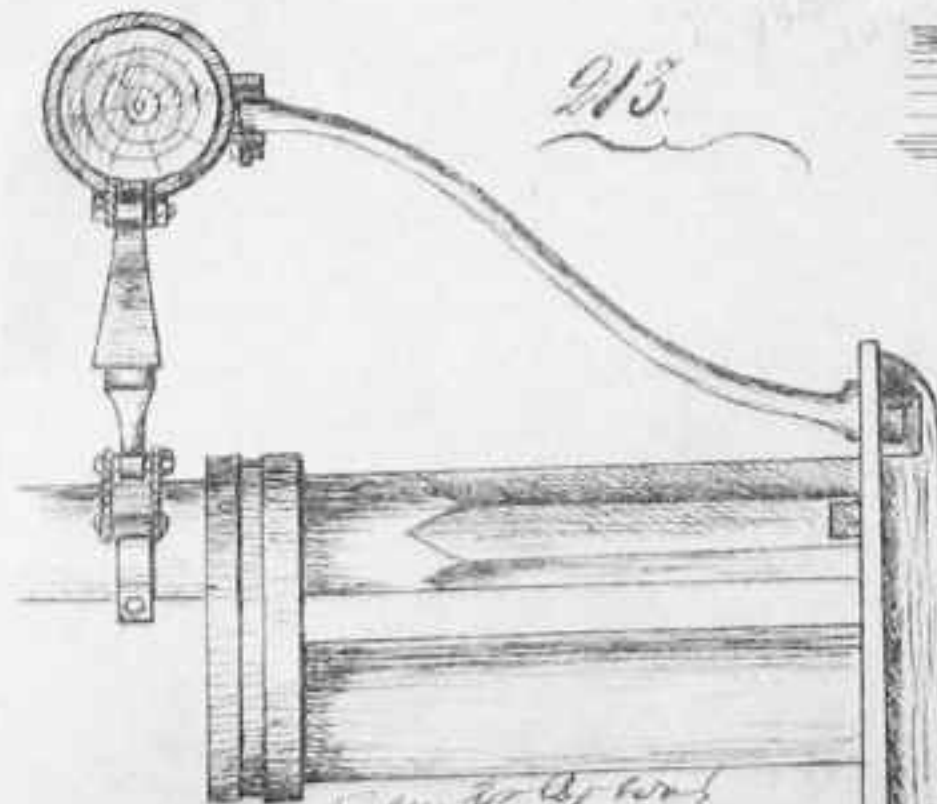
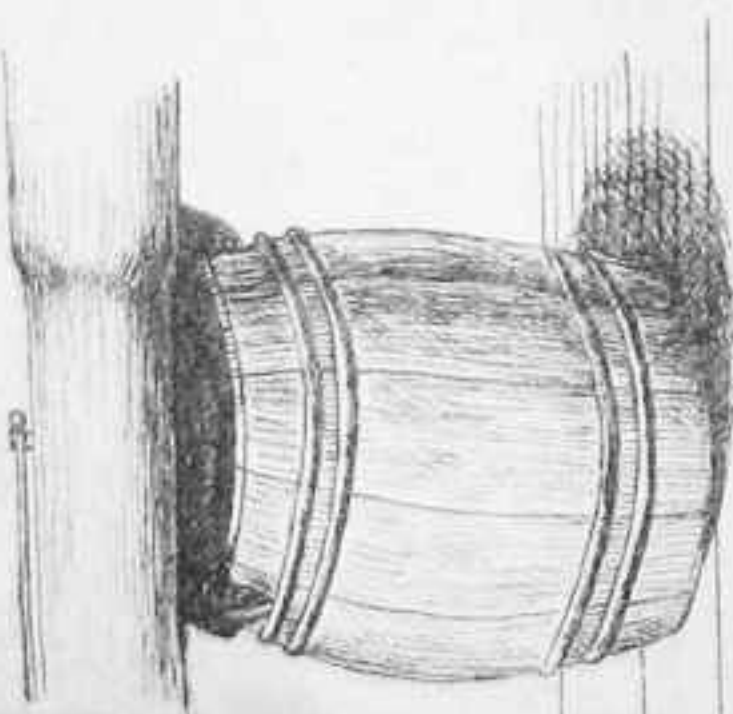

213

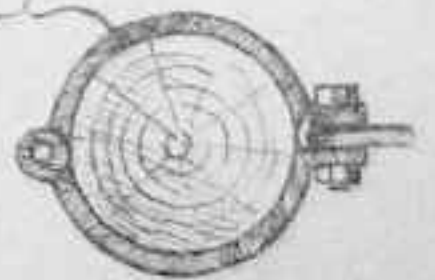
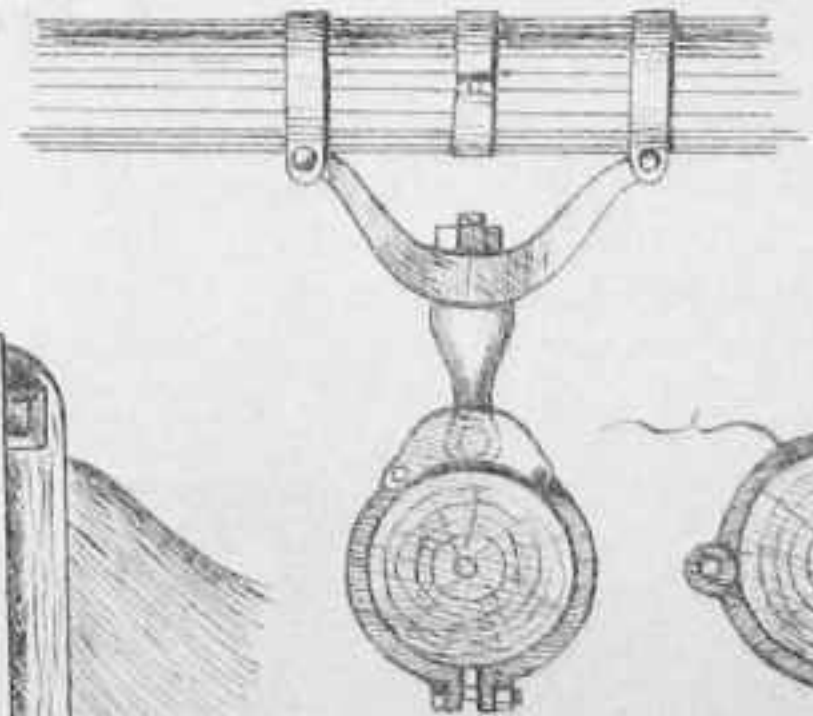

Can. by hand

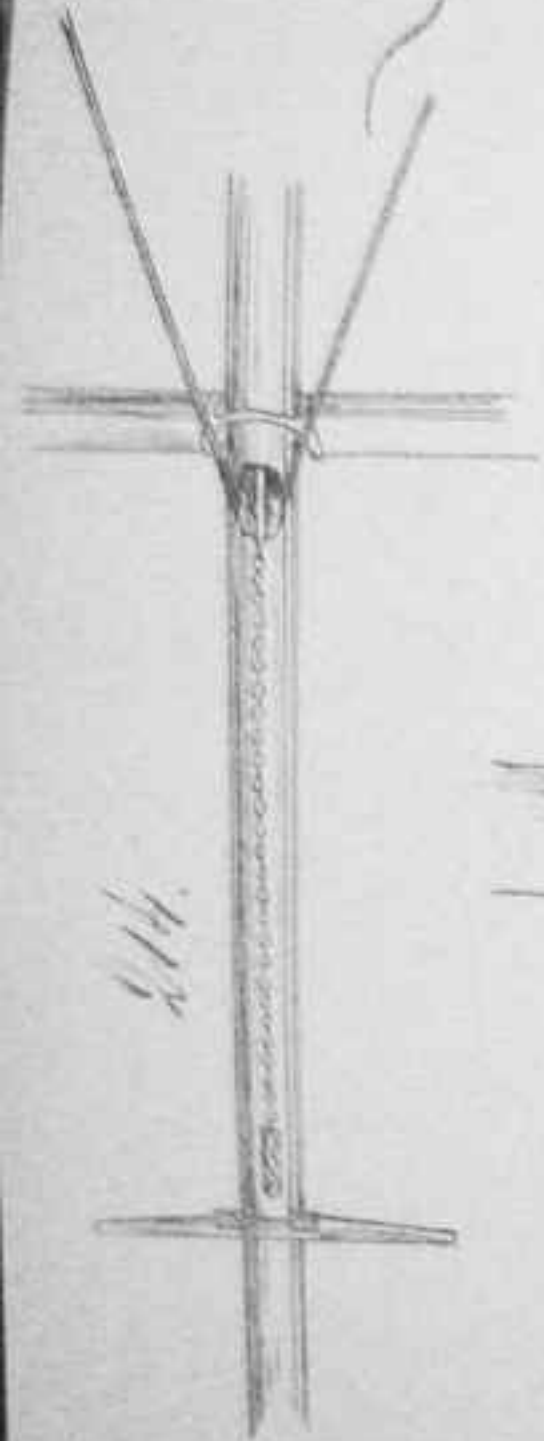

214.

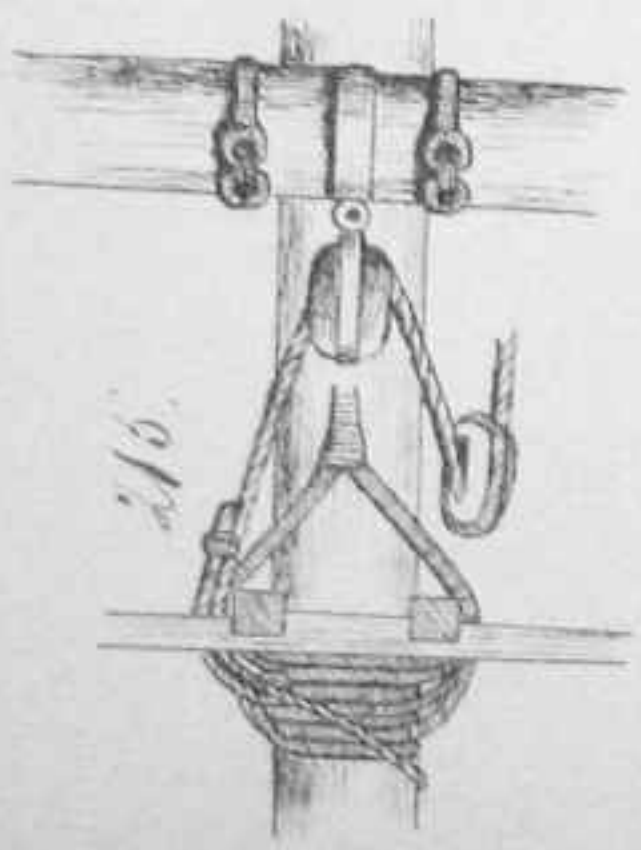

215.

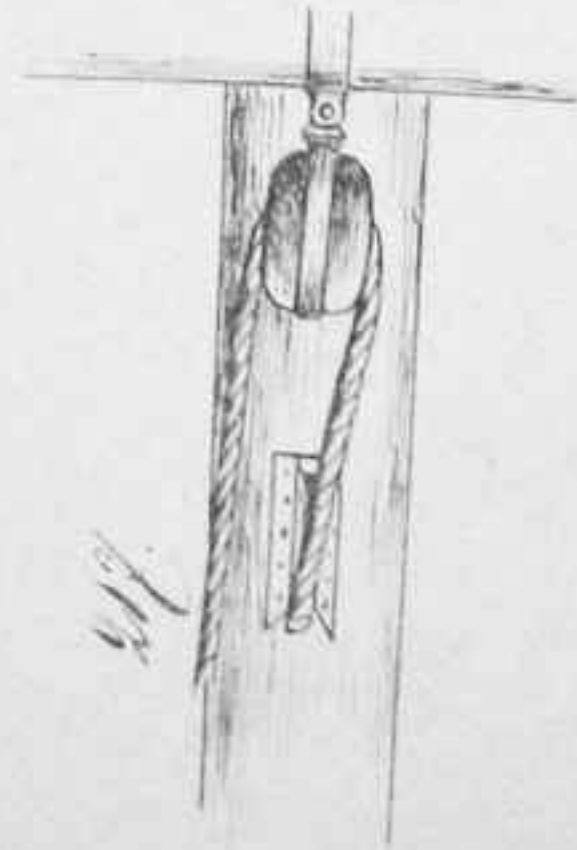

217.



218.



219.

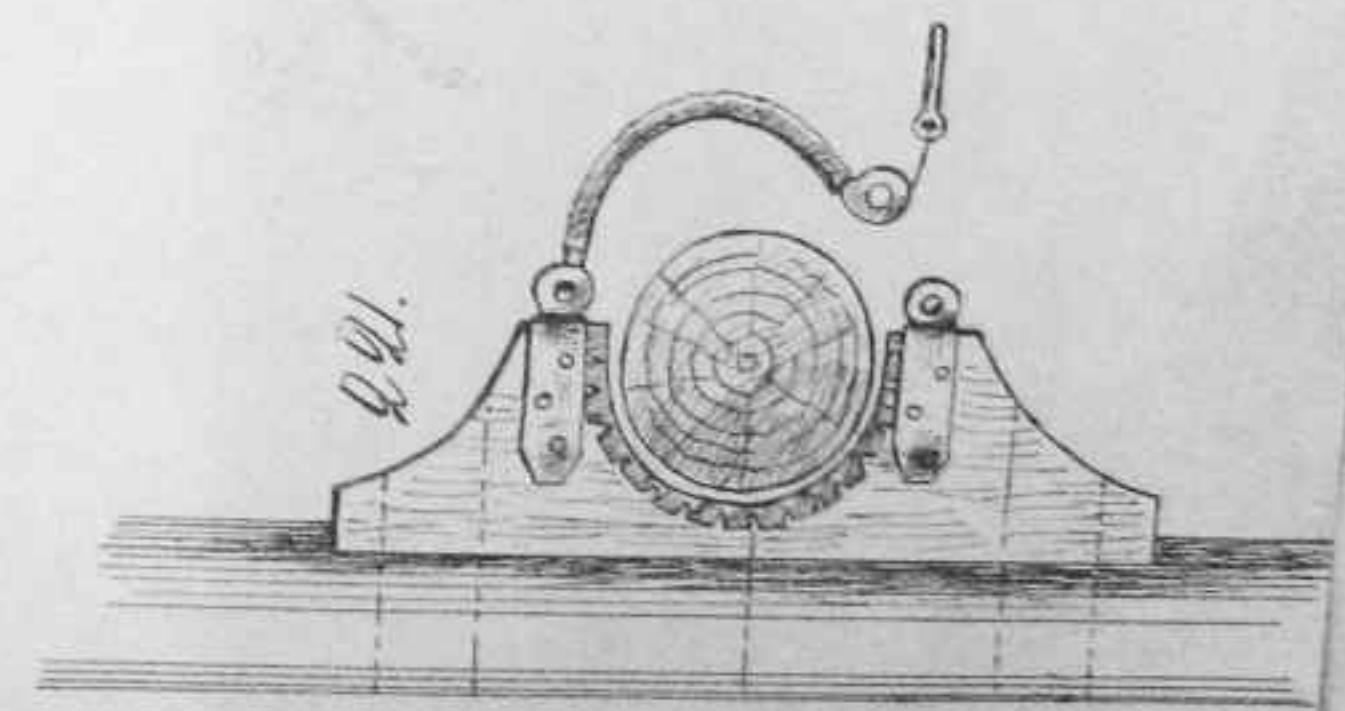
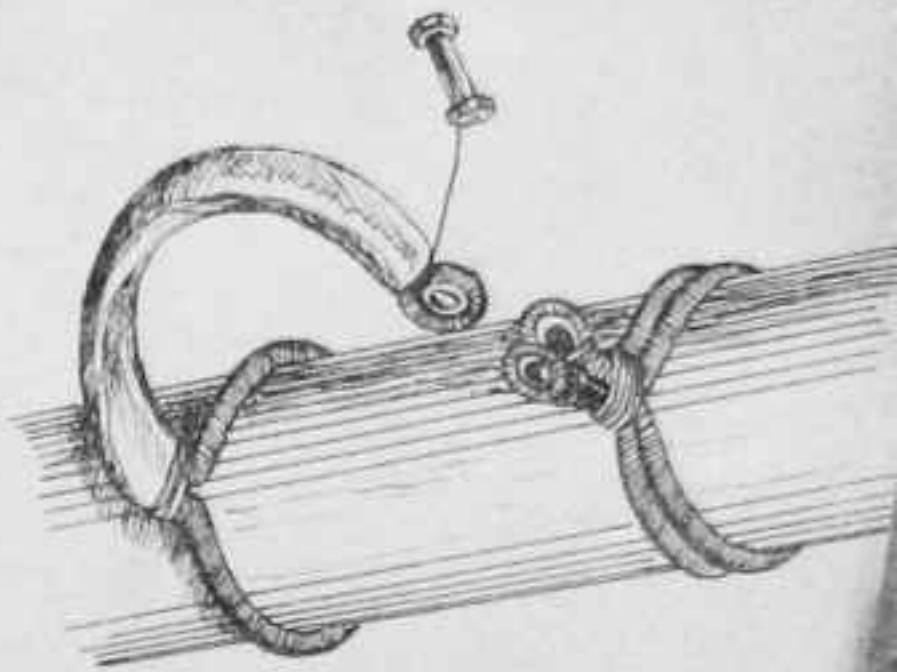

221.

From 20.

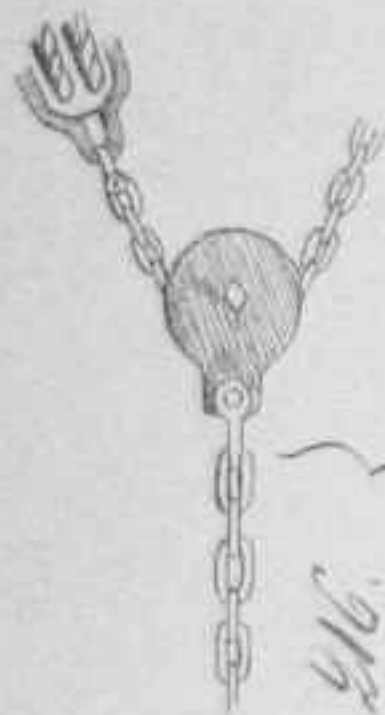

416.

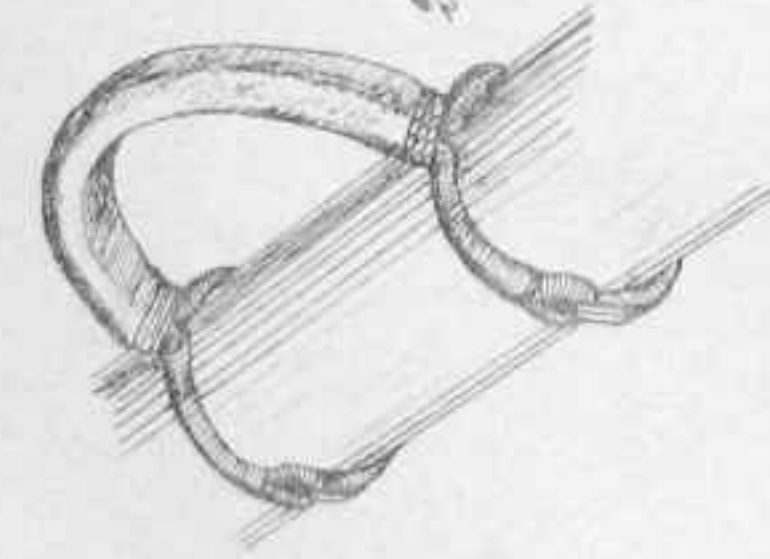
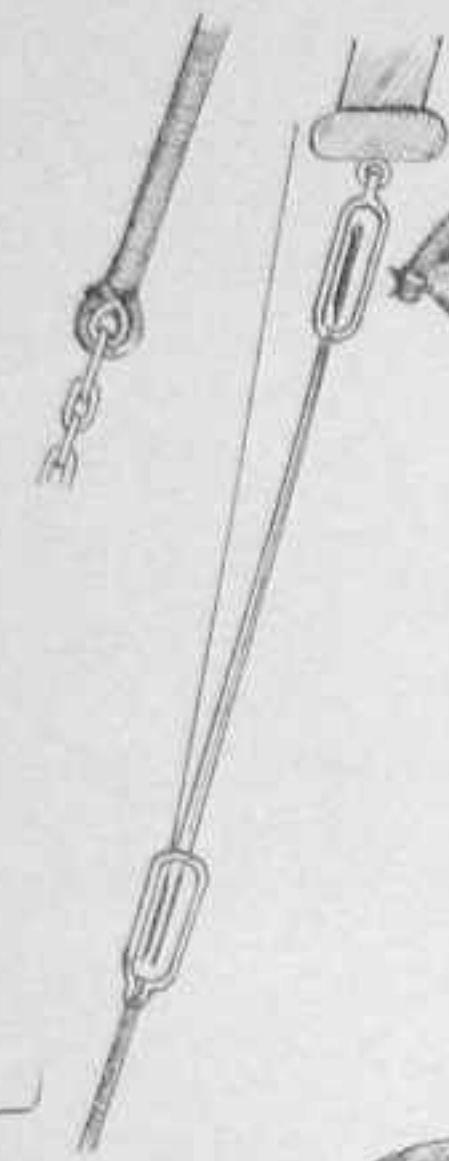

419.

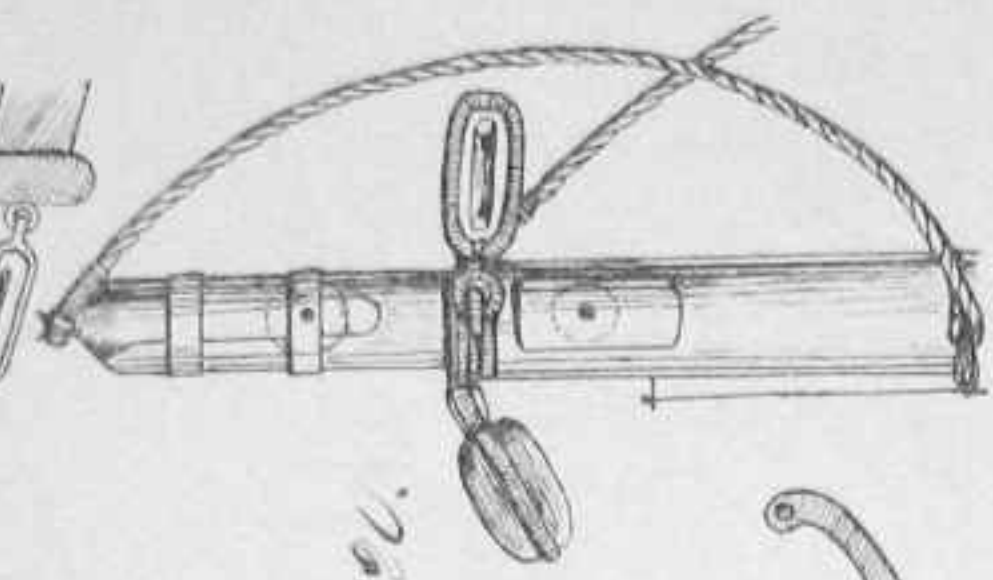

420.

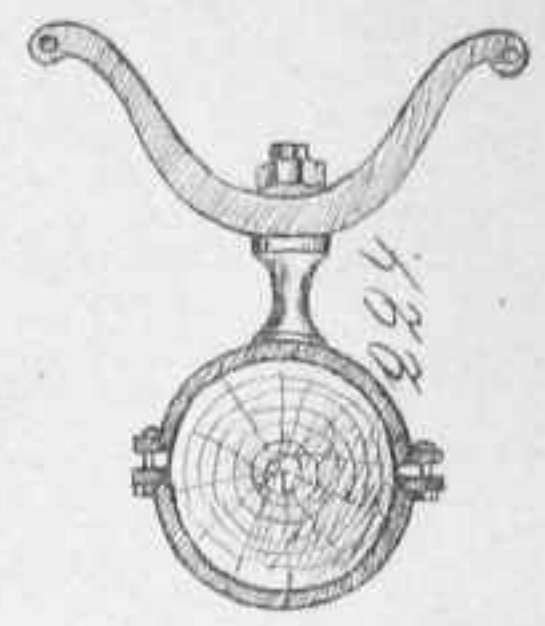

423.

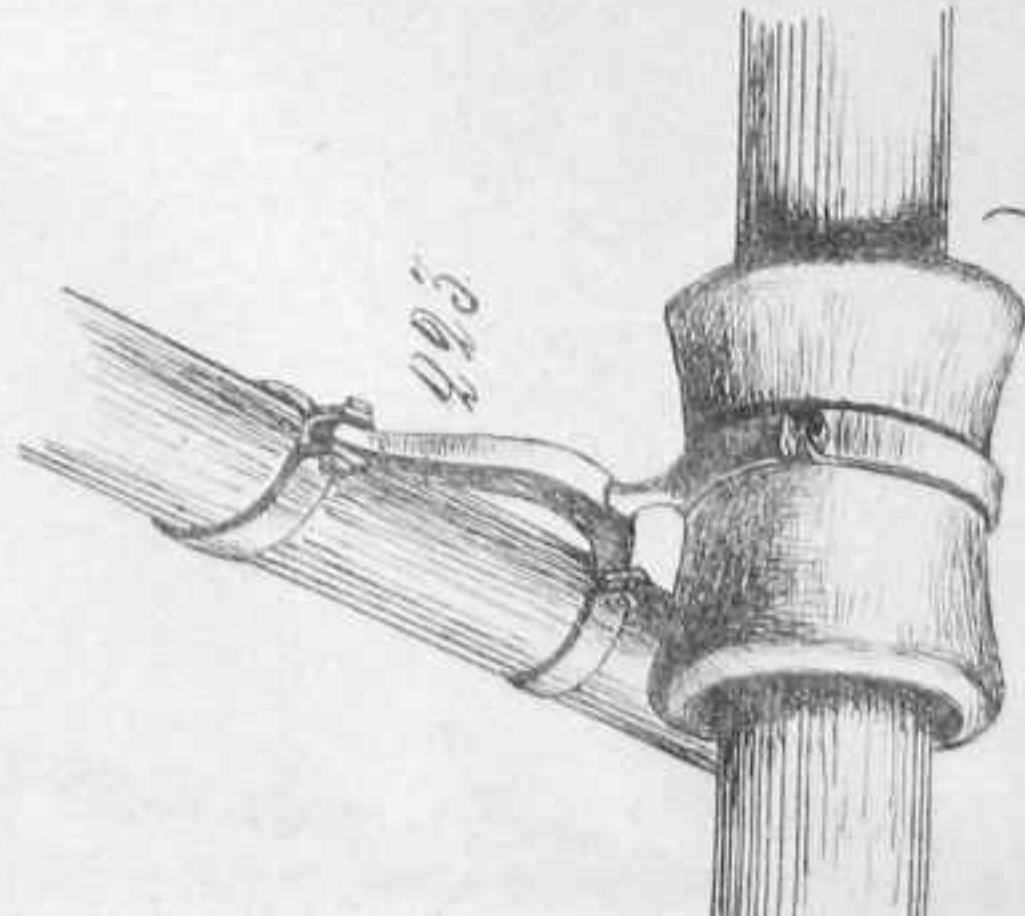

425.

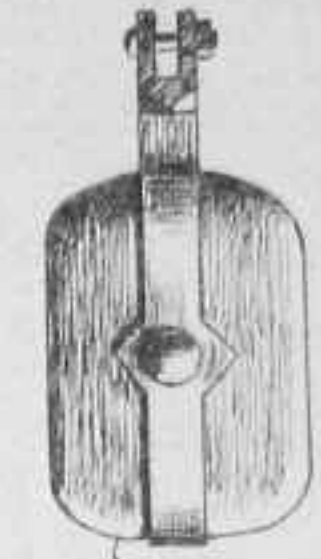

427.

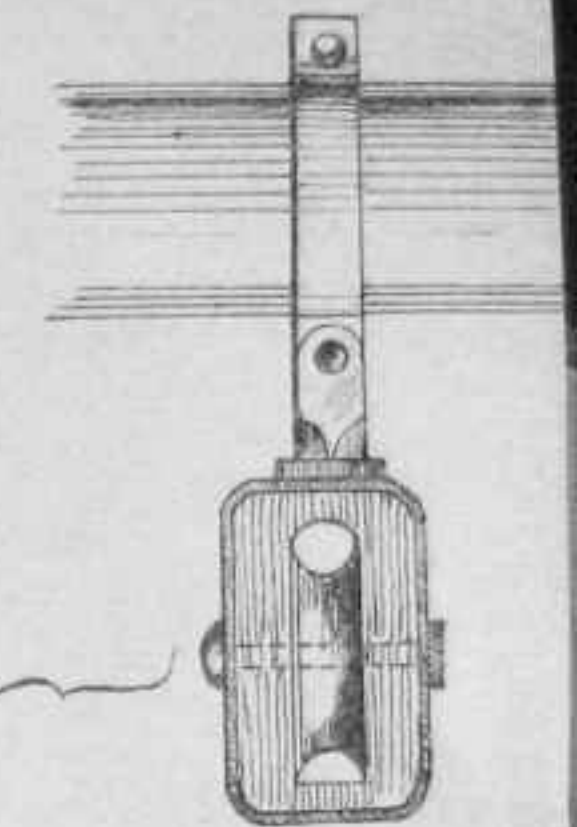

From 20-leaf...



228

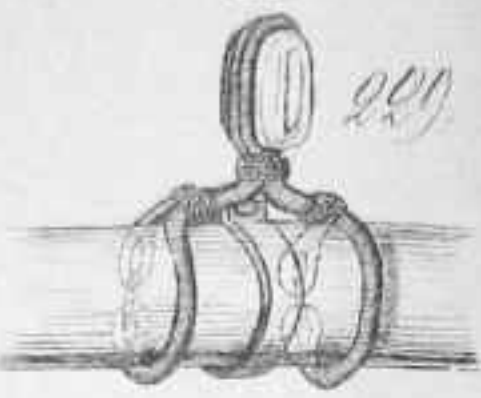

229



232



230

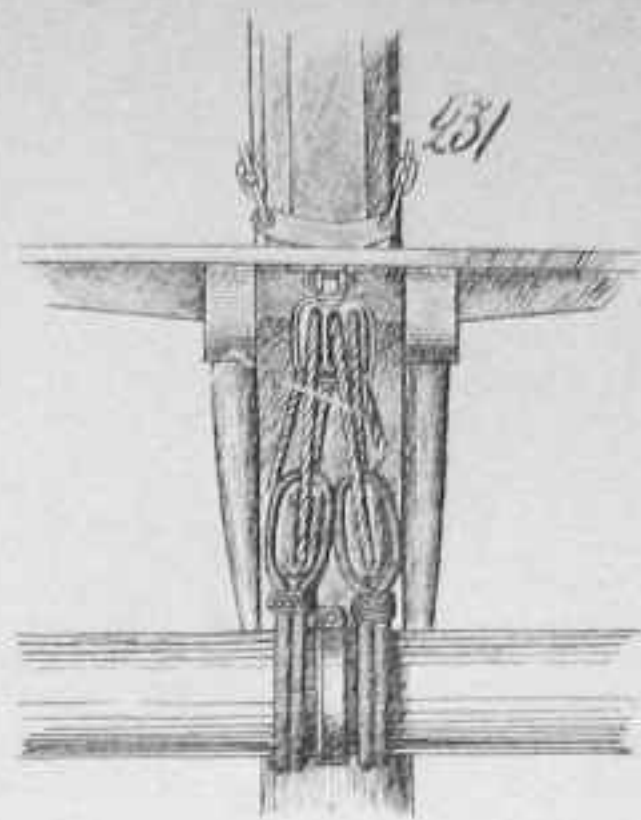

231



233

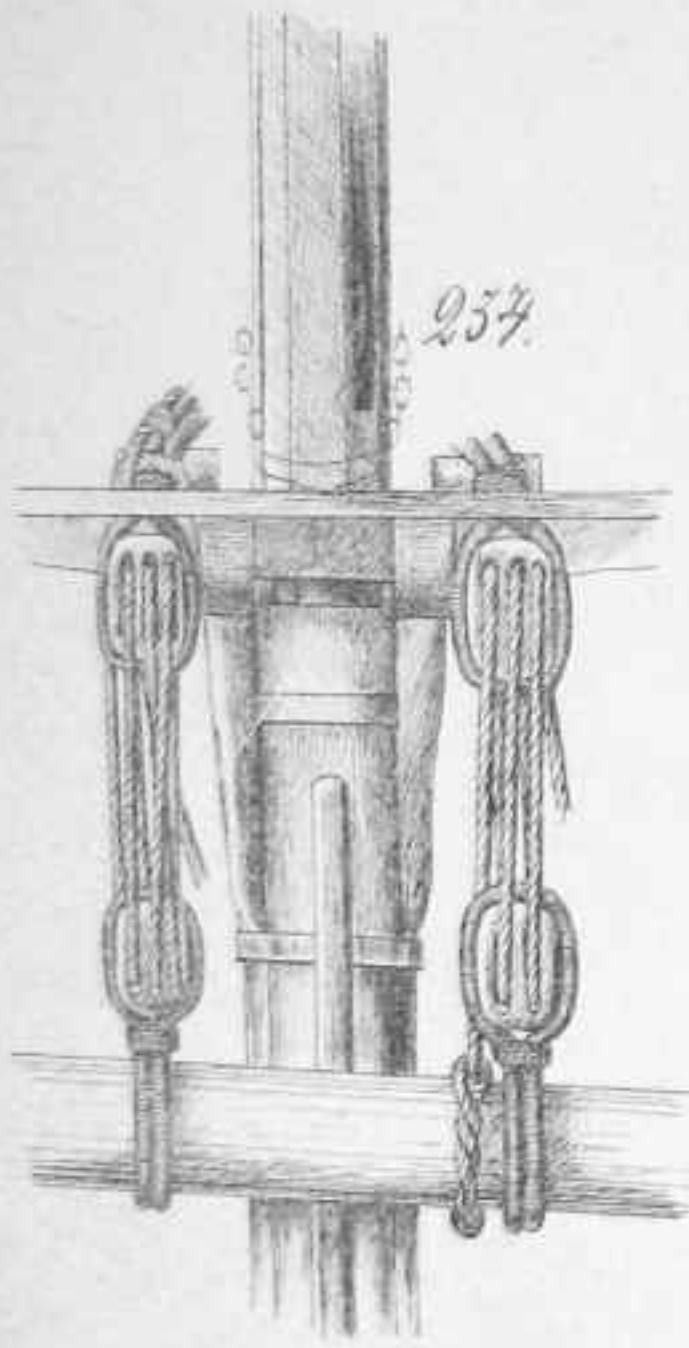

234

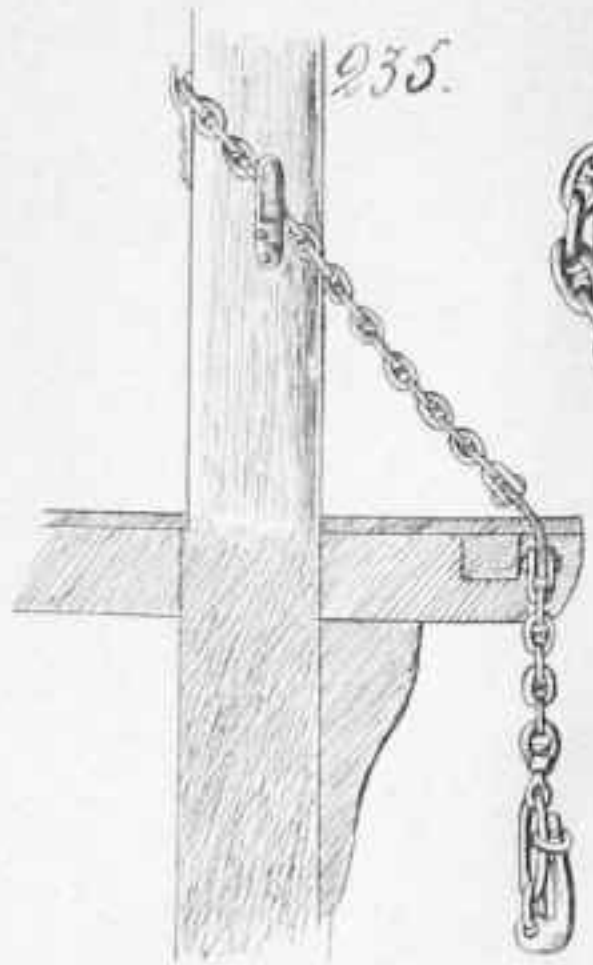

235



236

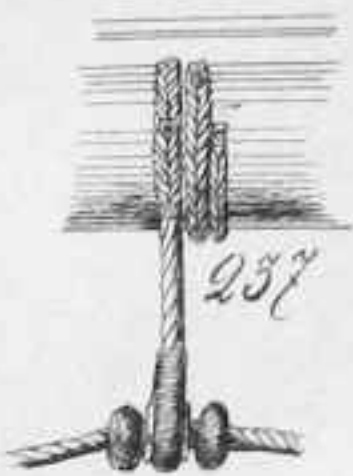

237

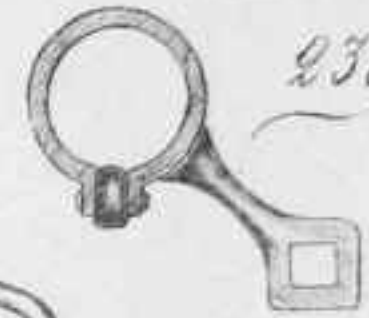

238

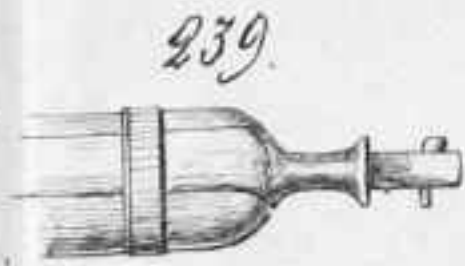

239



240

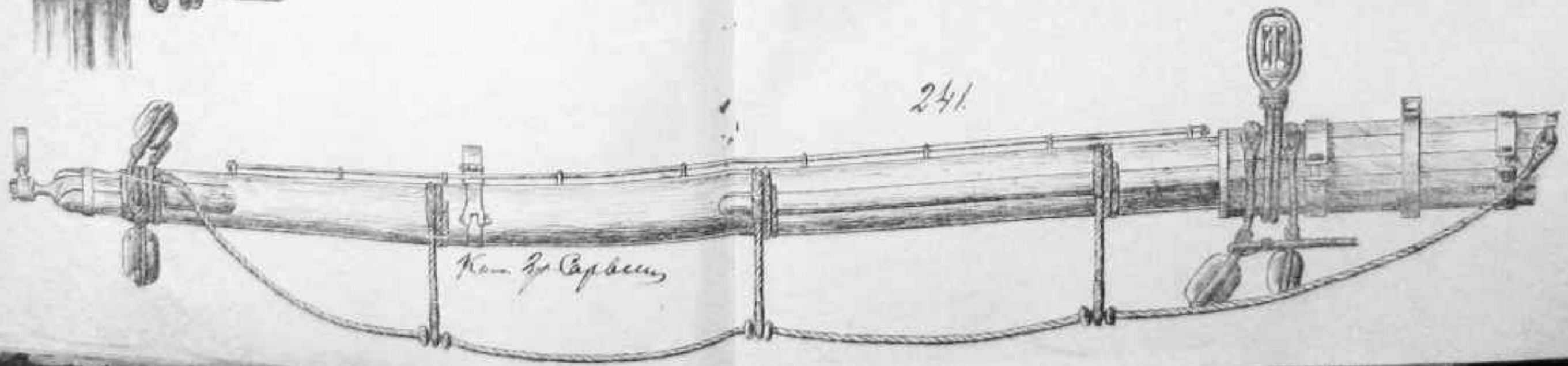

241

Kon 30 Caplens

Auxon 31.

242

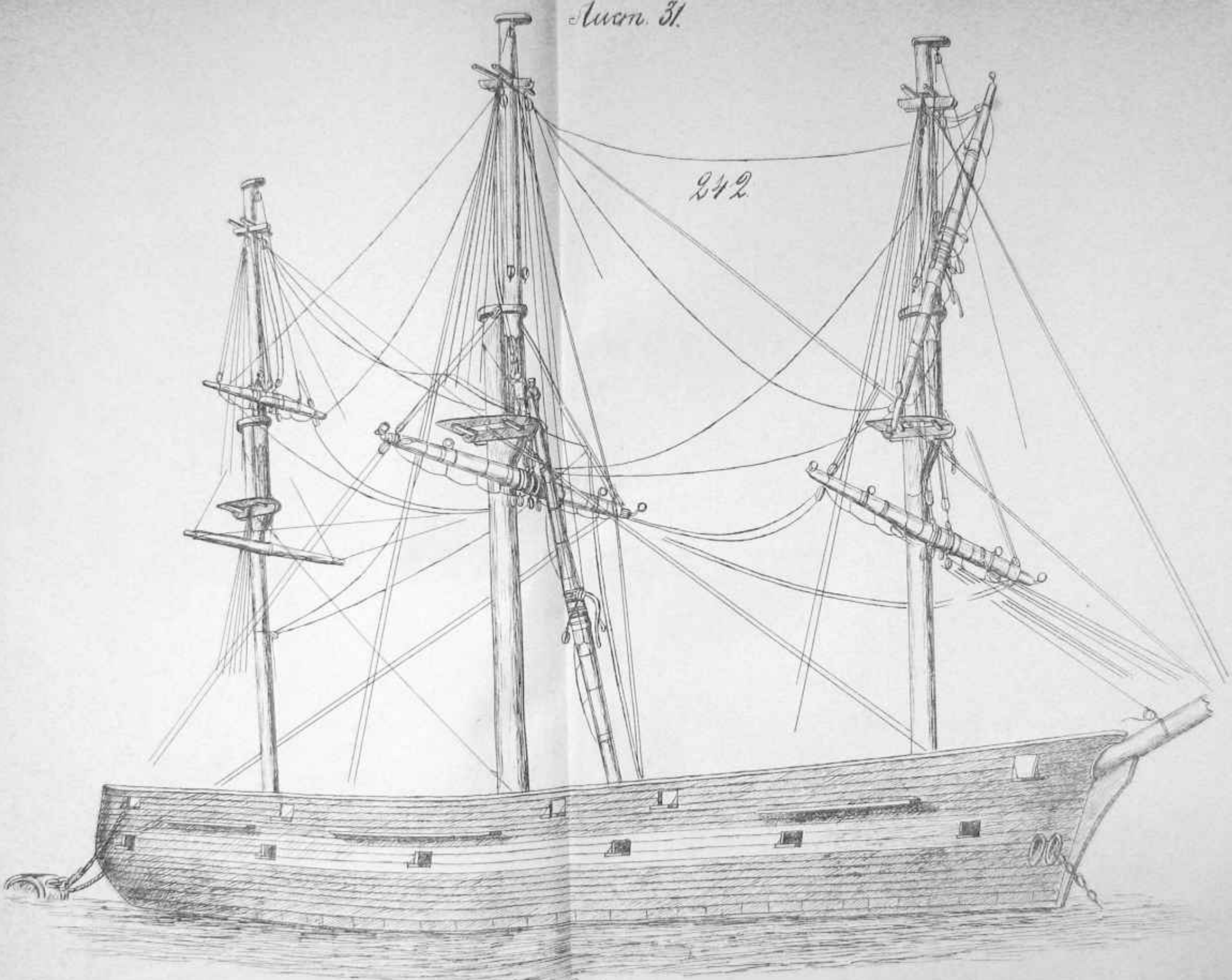

H. Auxon

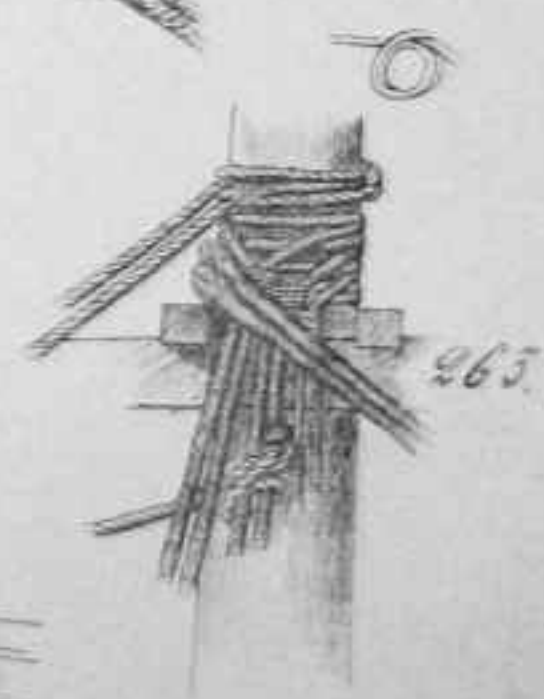
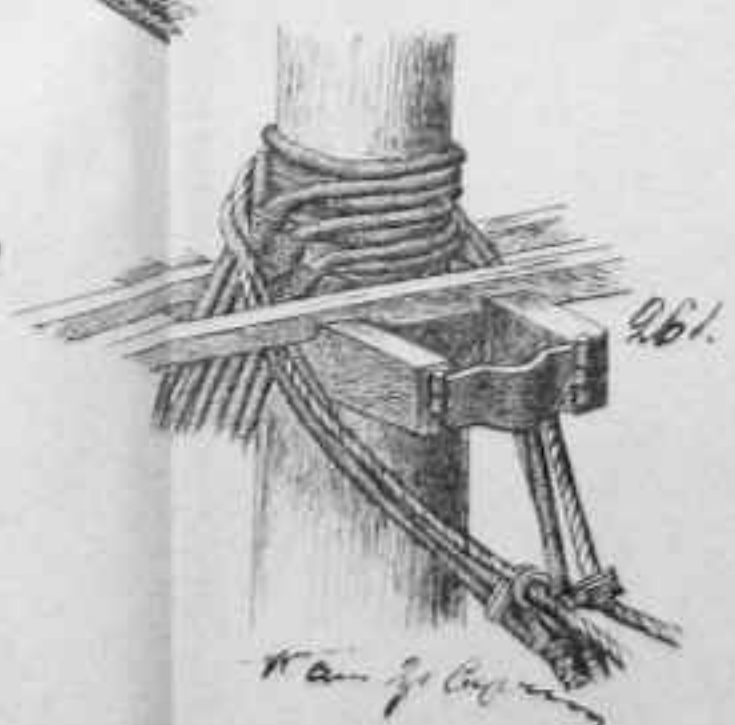
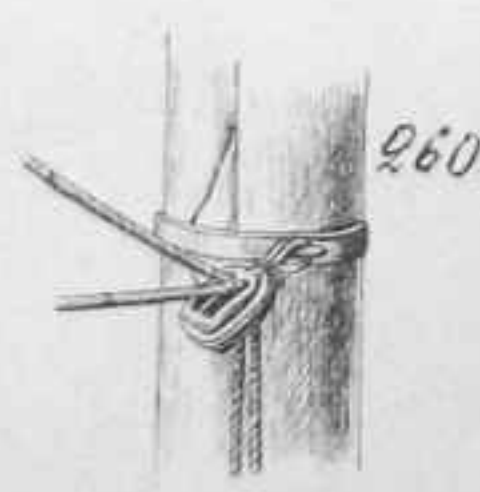
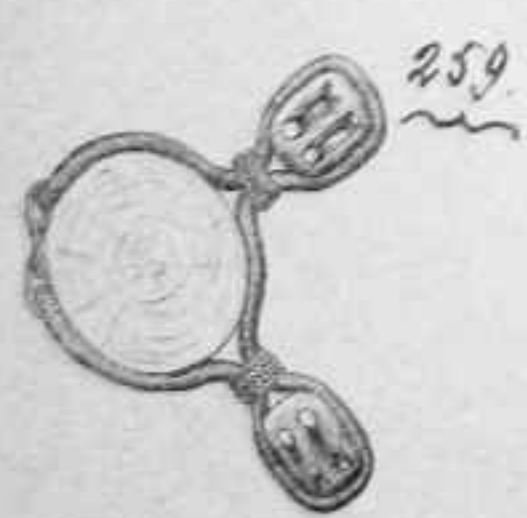
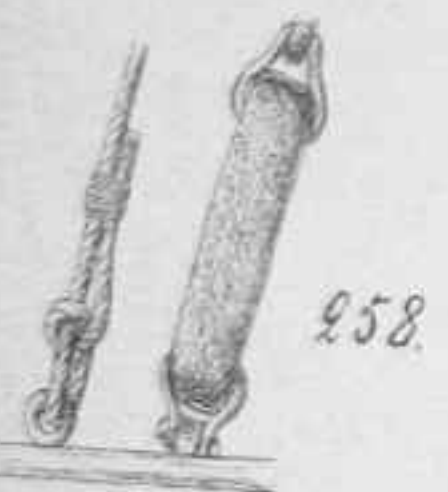
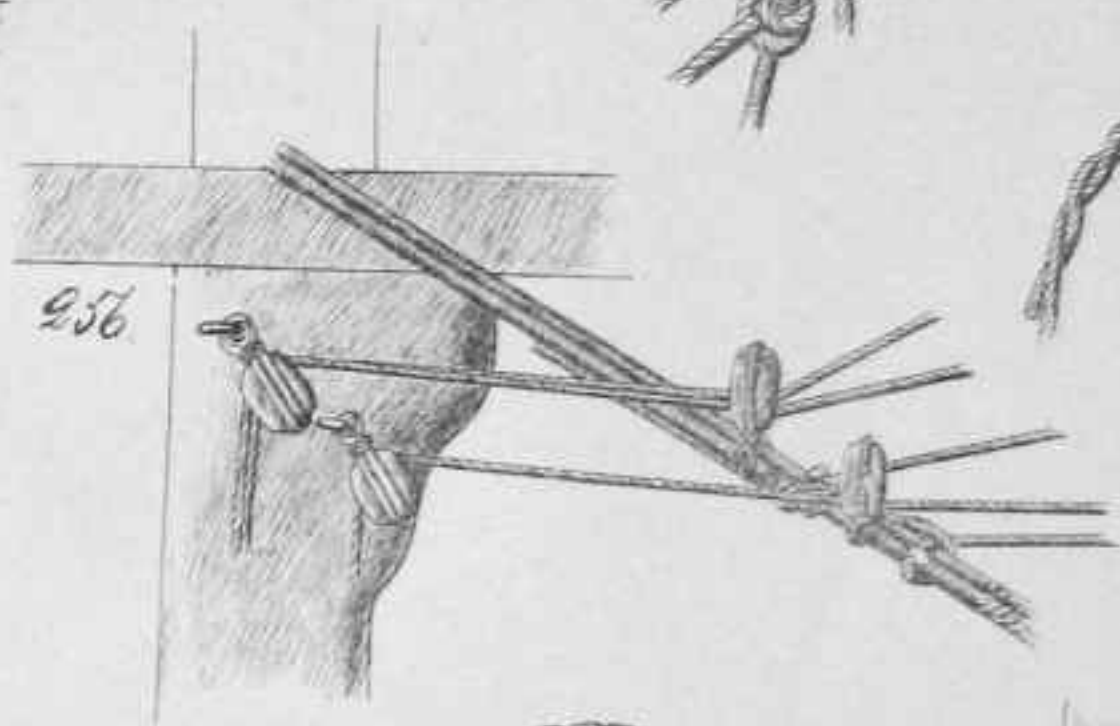
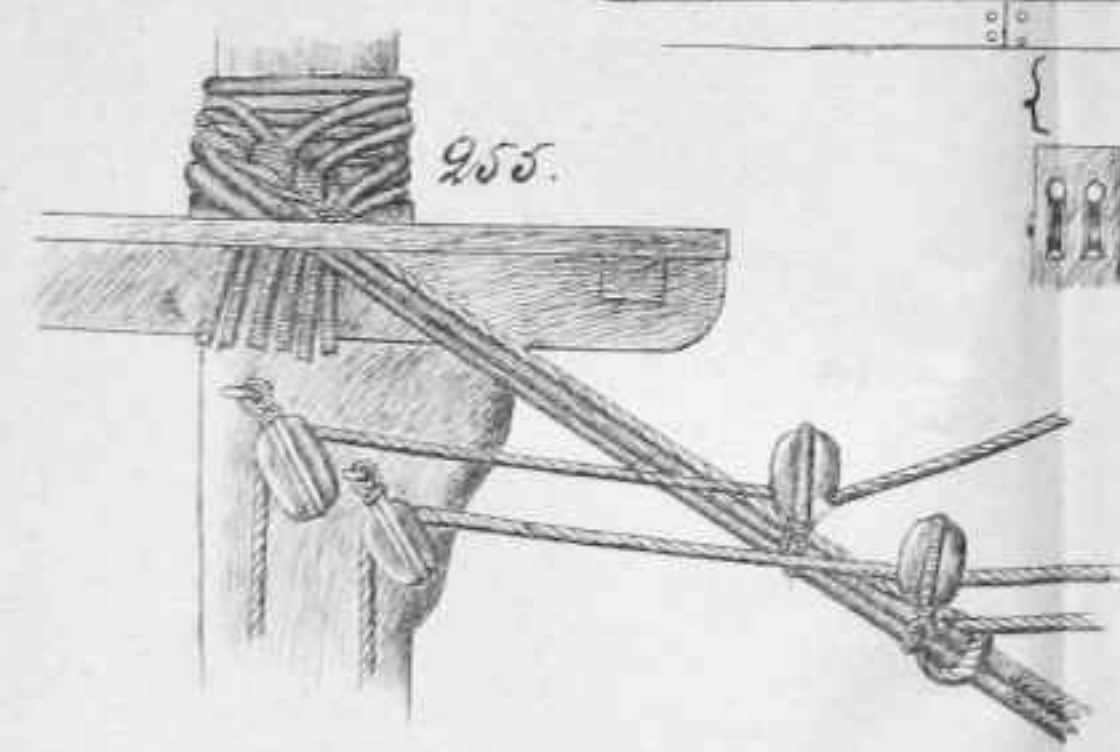
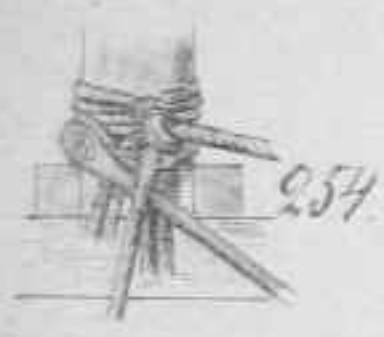
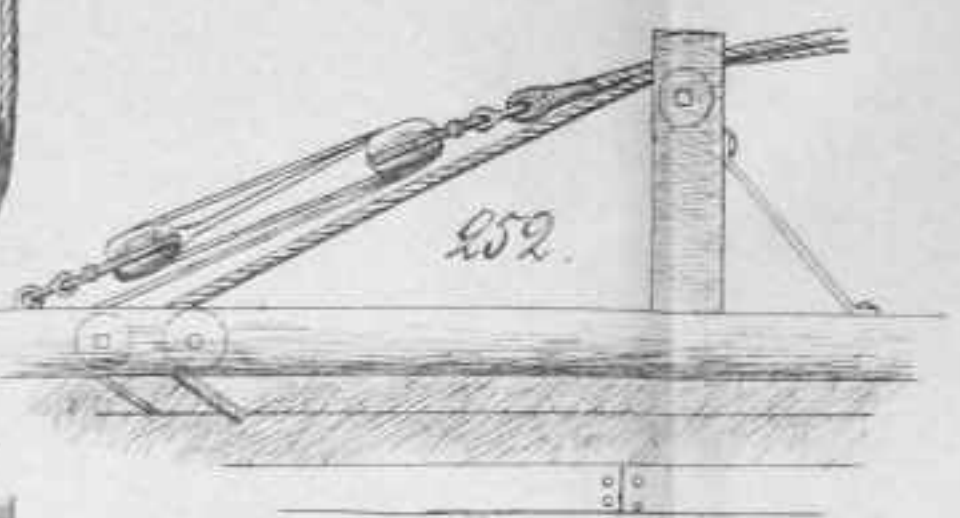
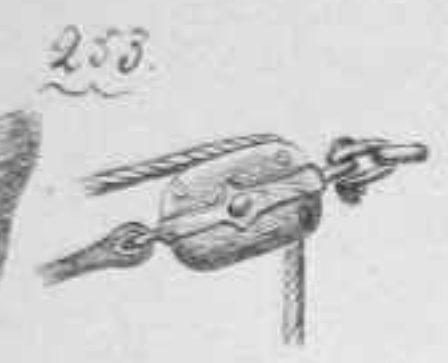
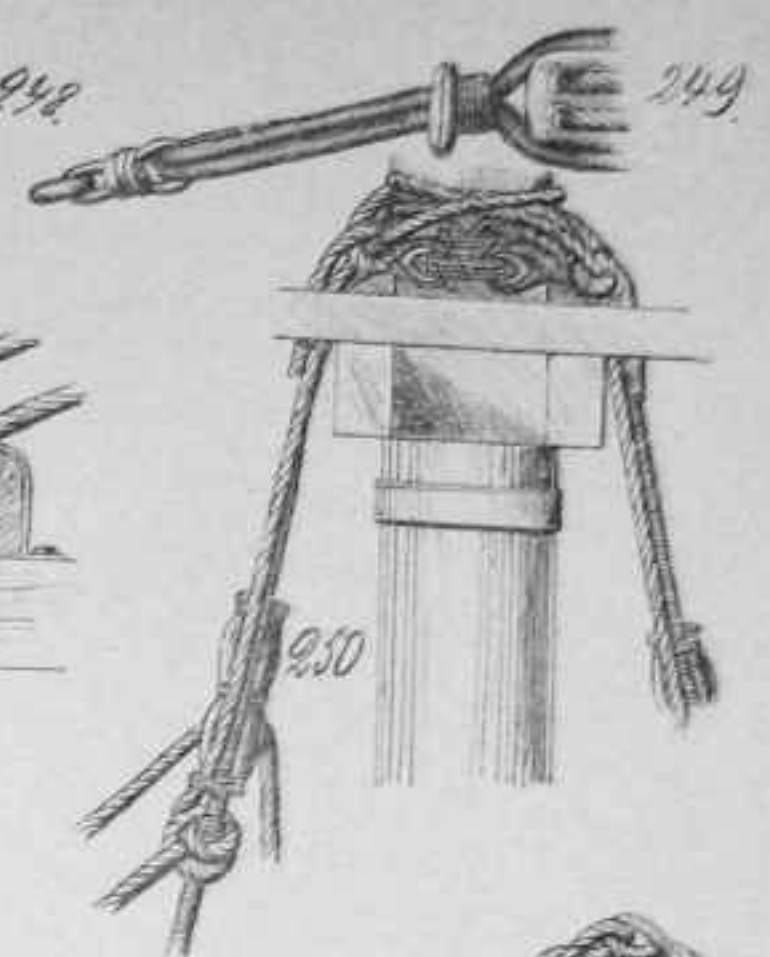
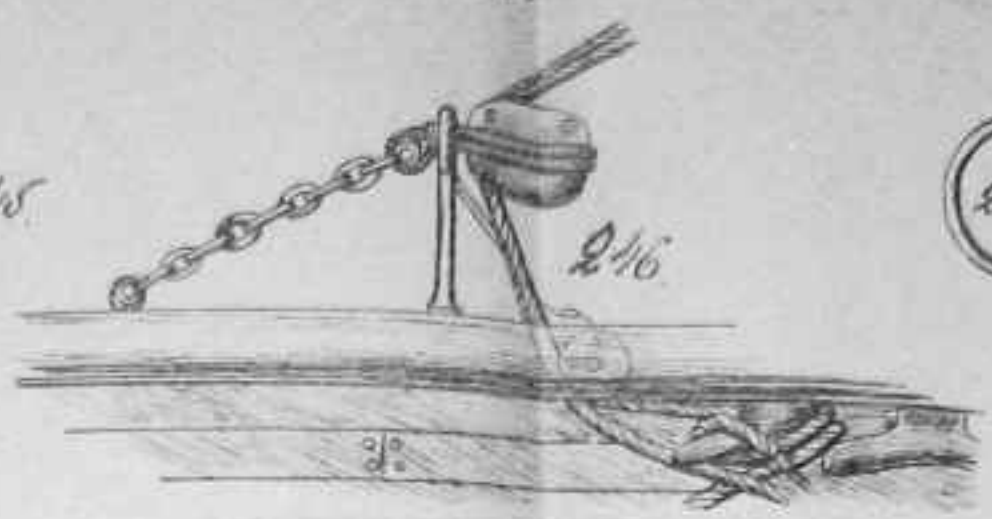
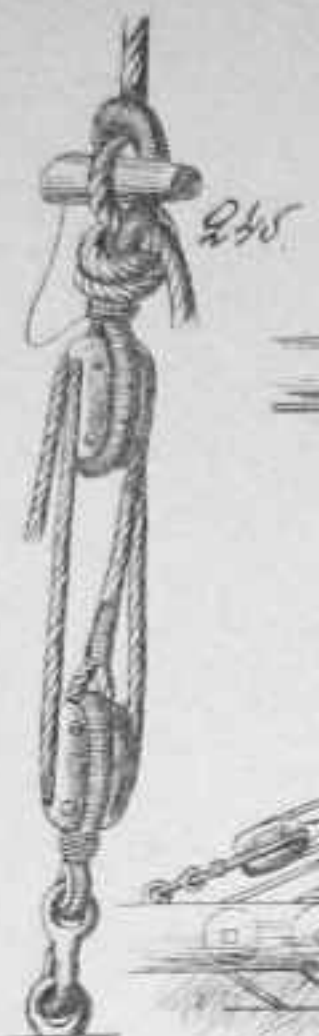
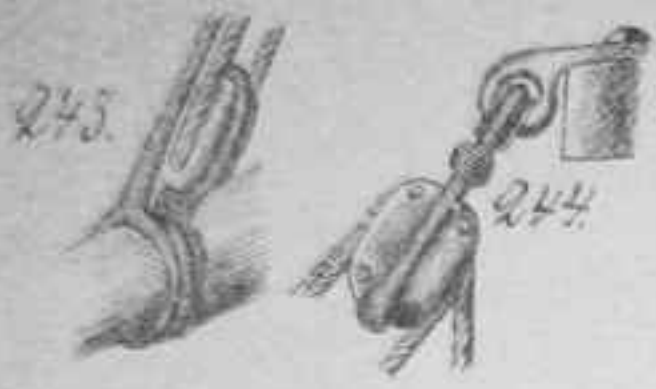

Handwritten signature or text at the bottom center.

265



266



268

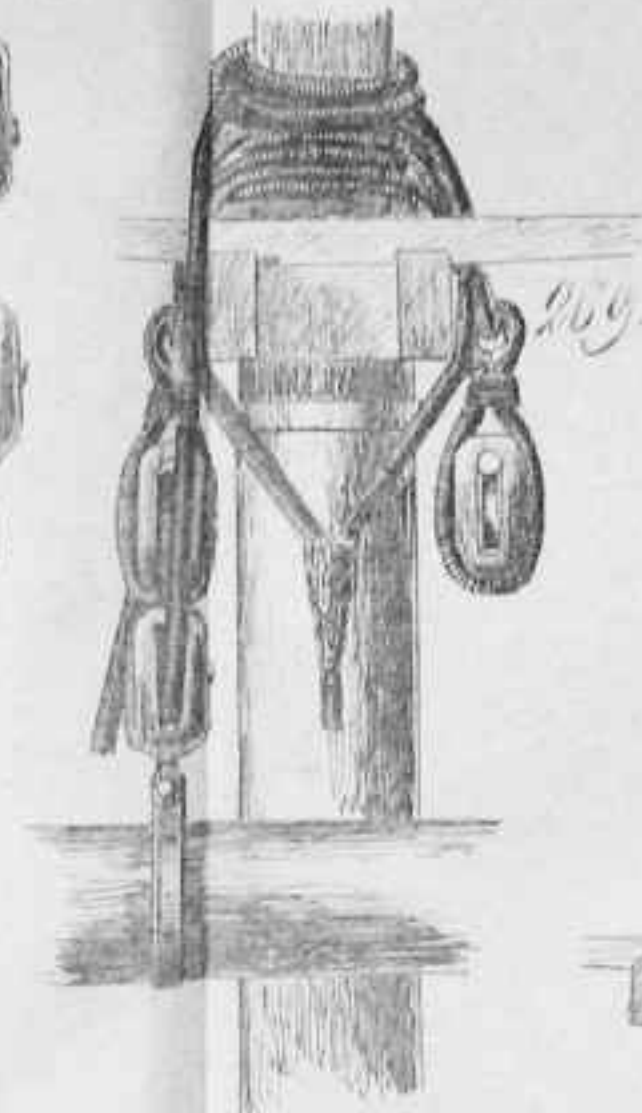

269

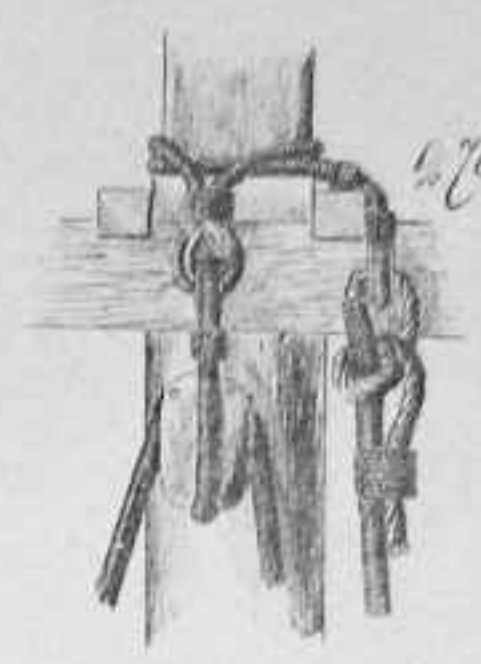

270

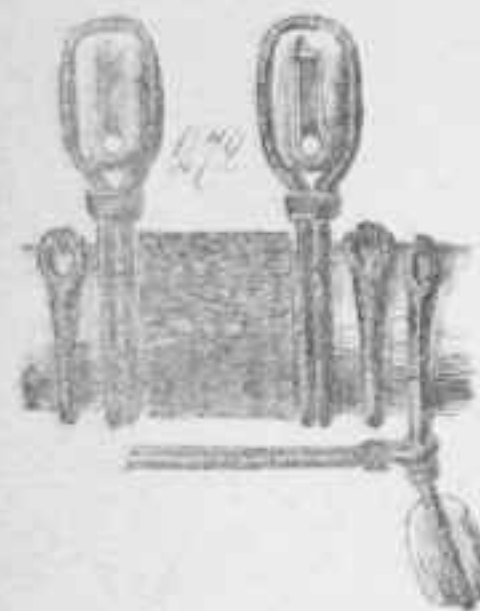

271



273

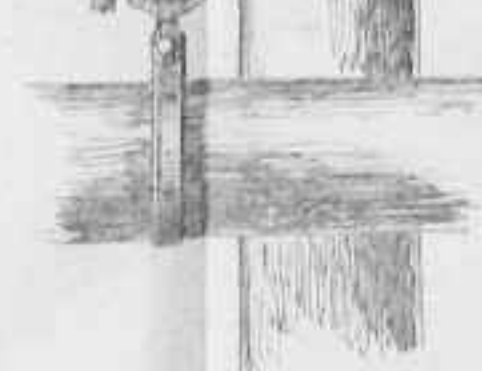

274

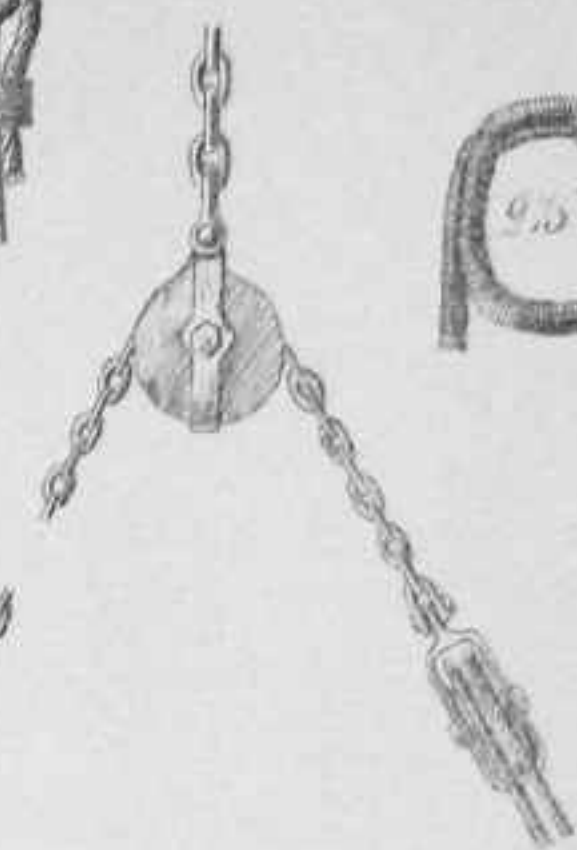

275



276

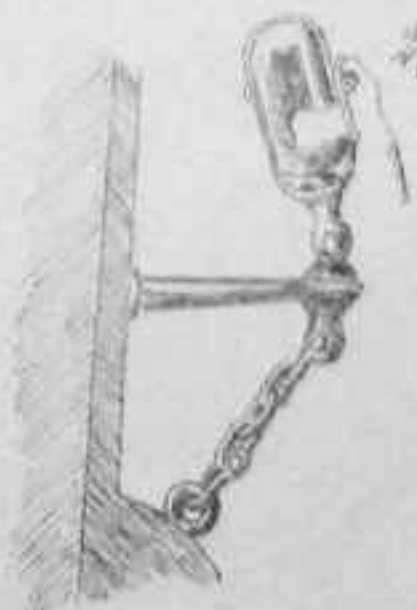

277

Handwritten text at the bottom of the page, possibly a signature or a note.

178

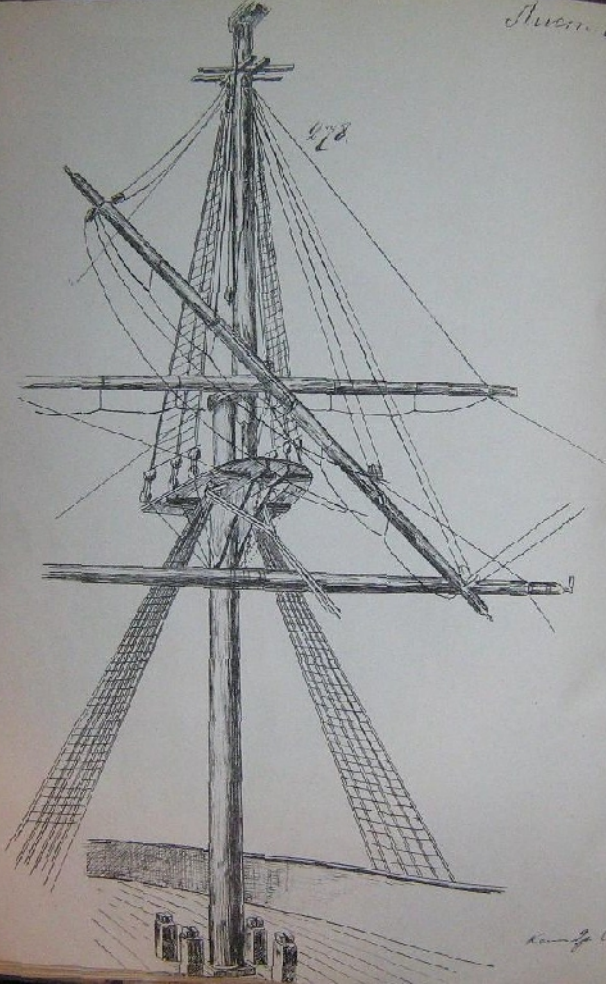

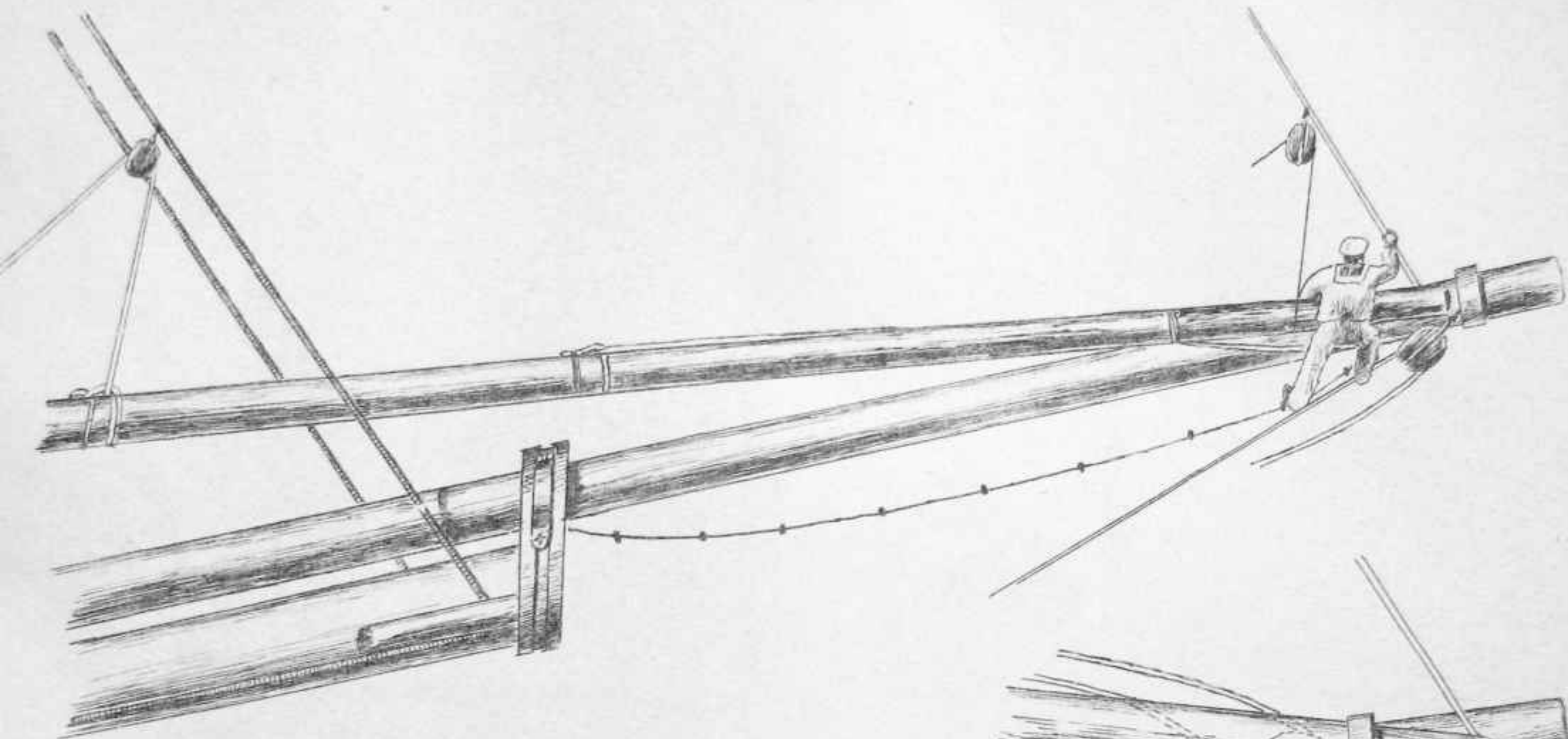
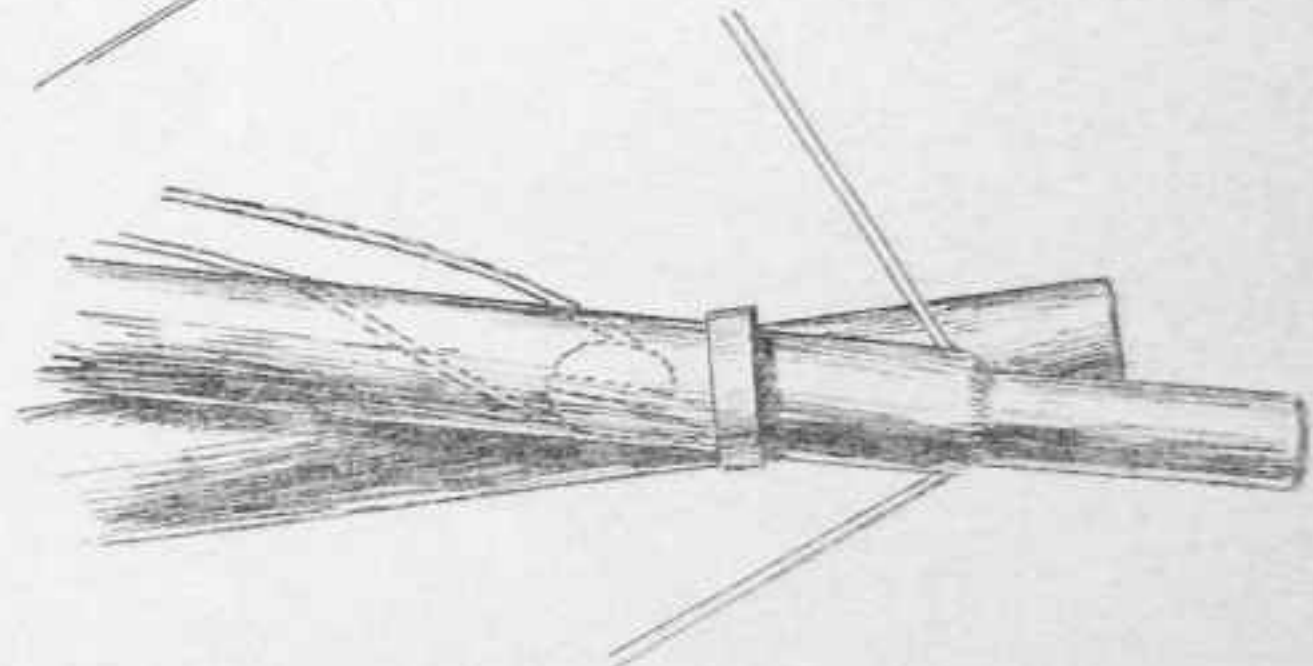
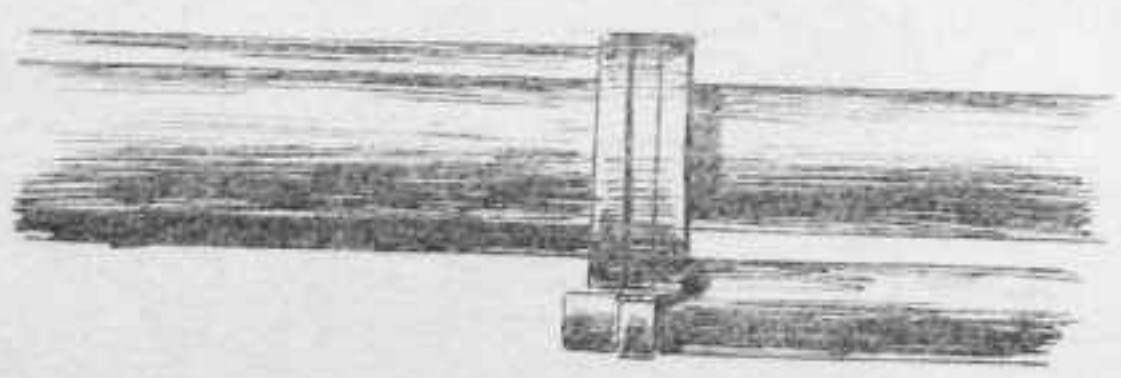
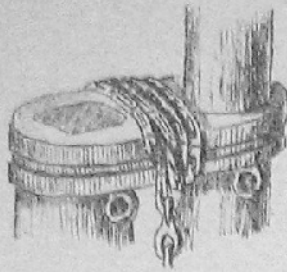

Fig. 20



280



281

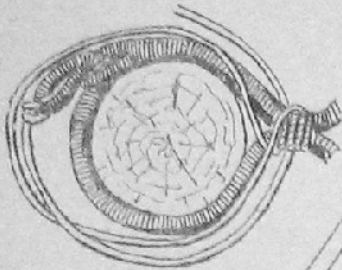

282

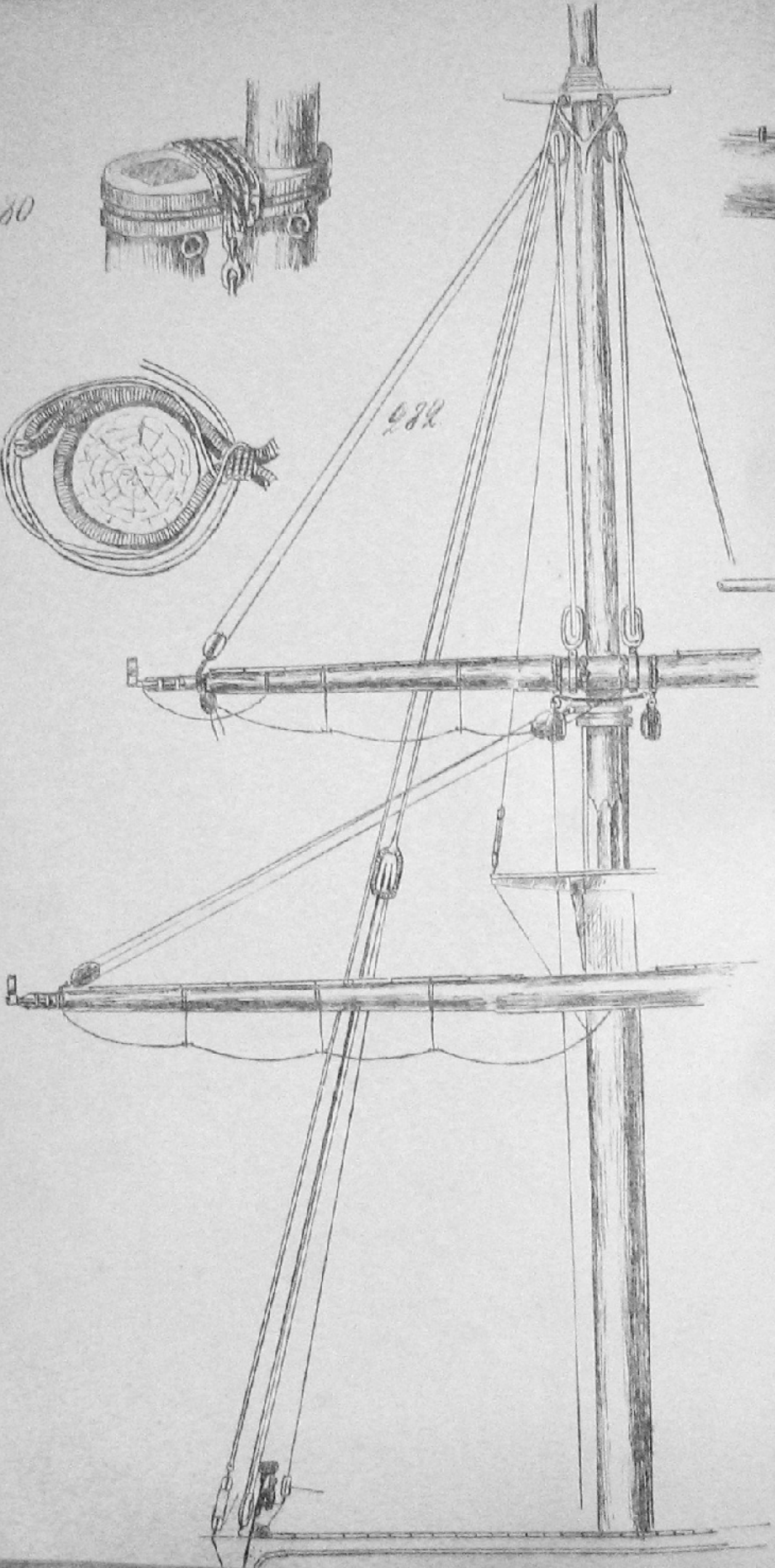

Num 35.

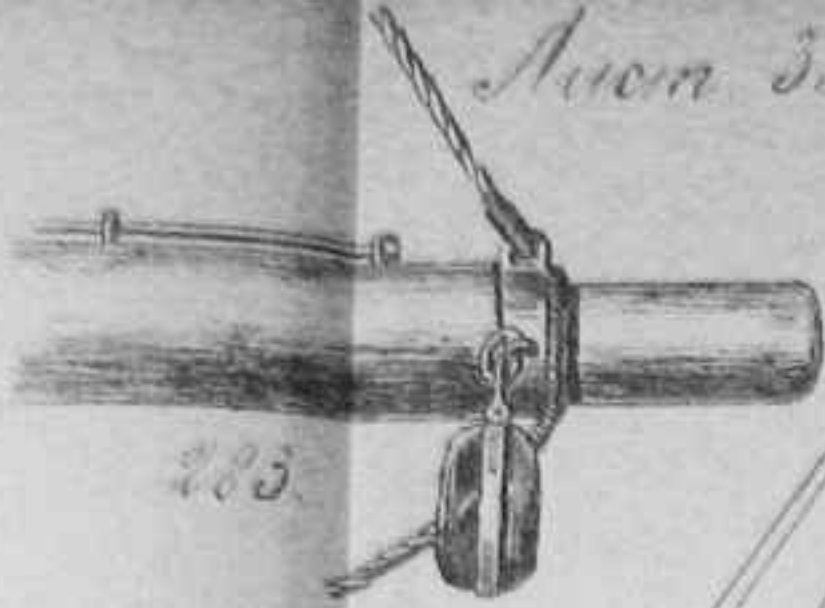

283.

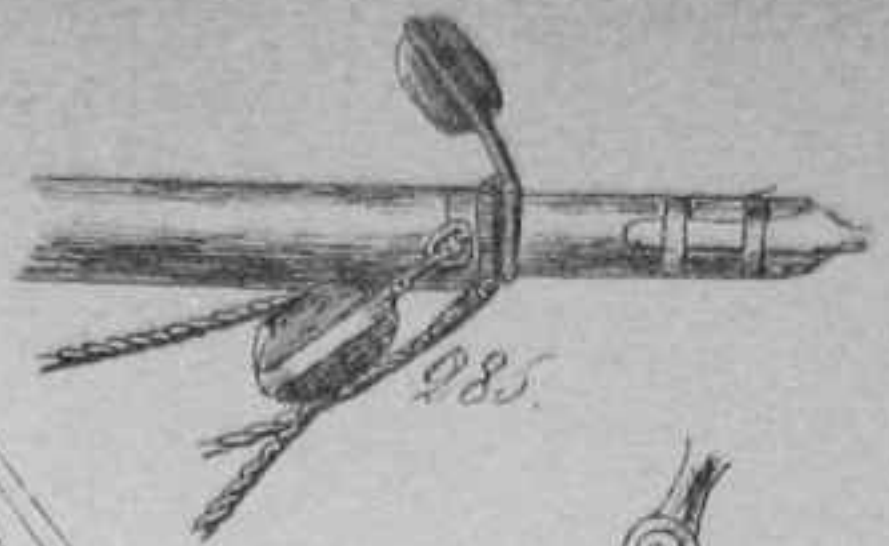

285.

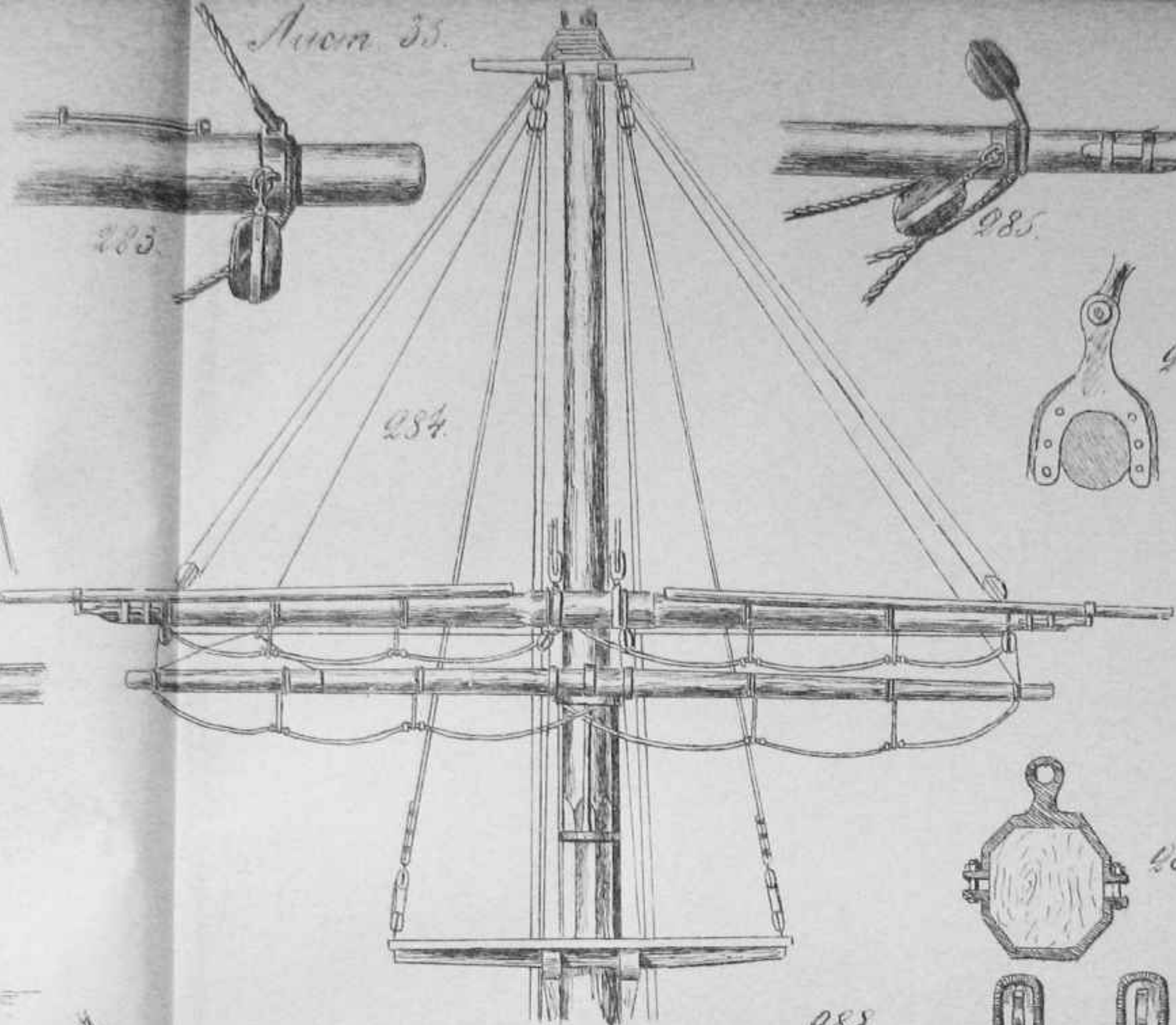

284.



286.

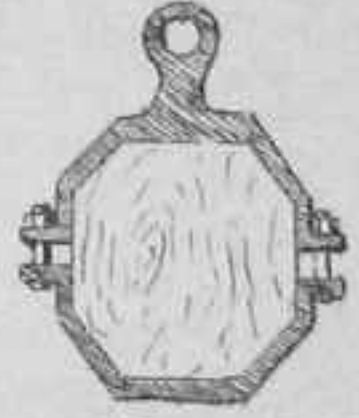

287.

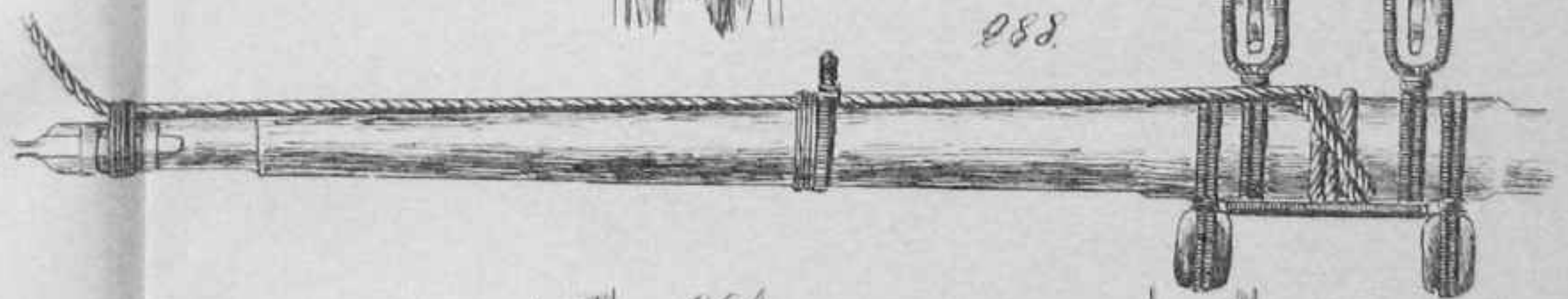

288.

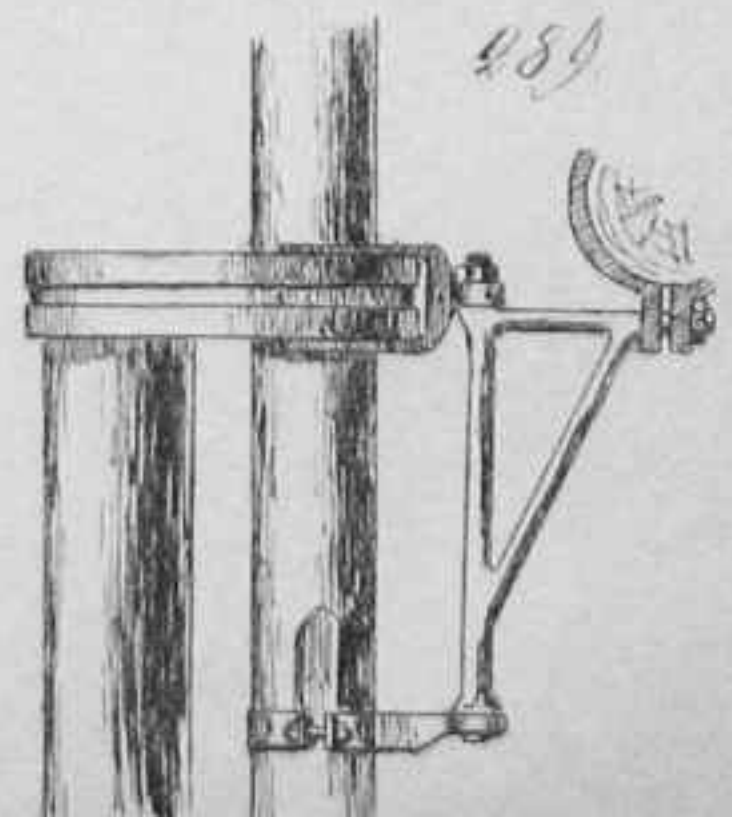

289.

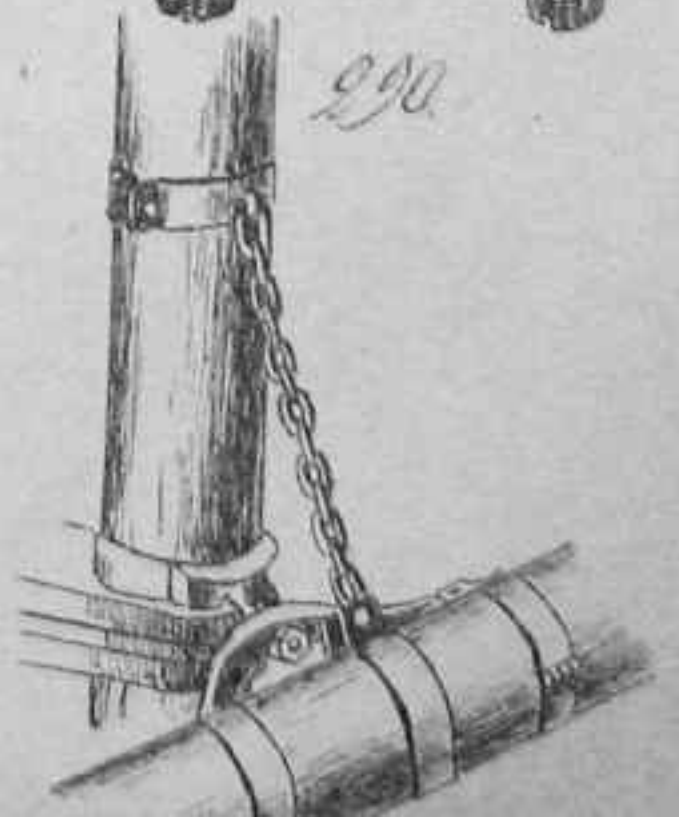

290.

See 2. 1. 1. 1.

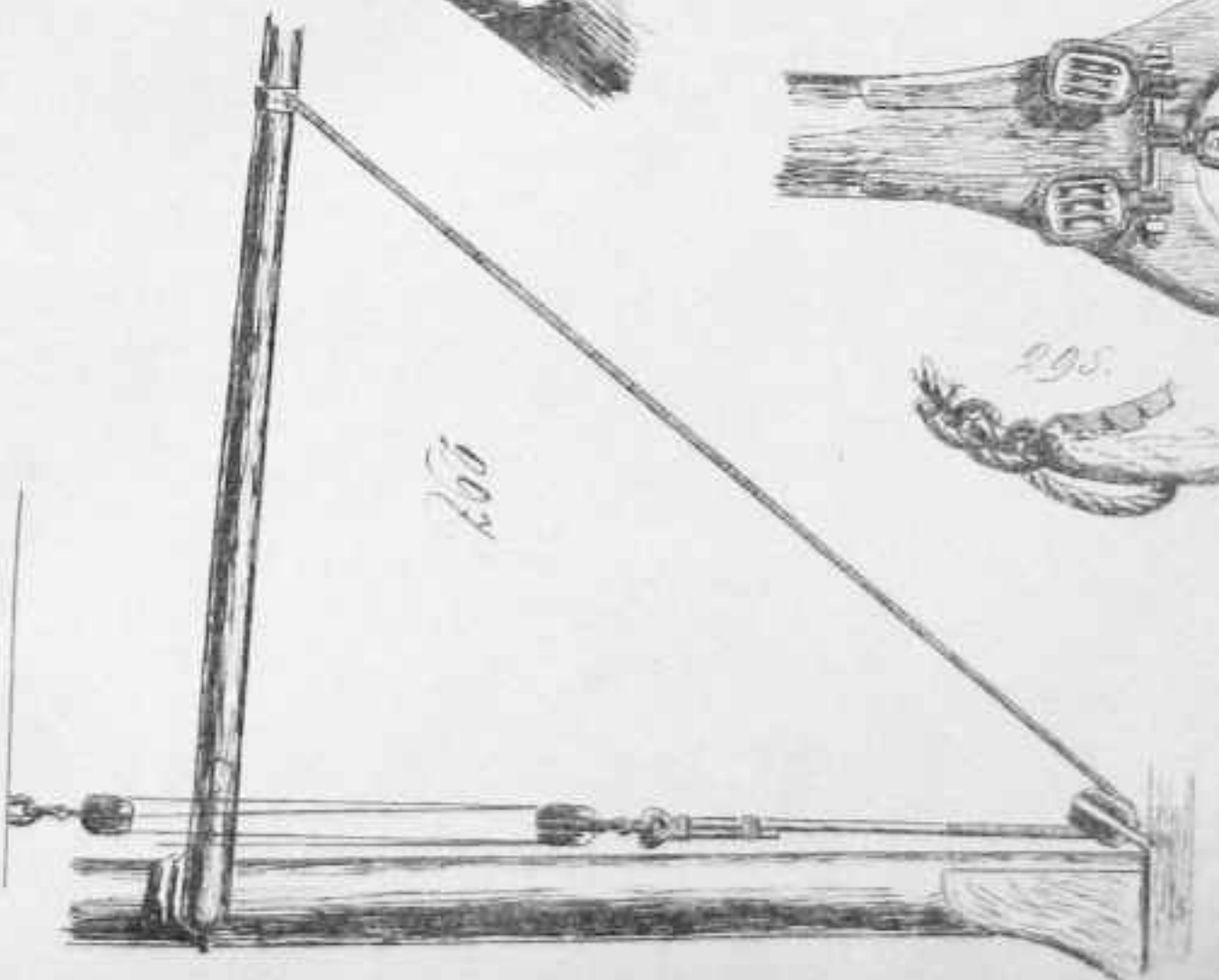
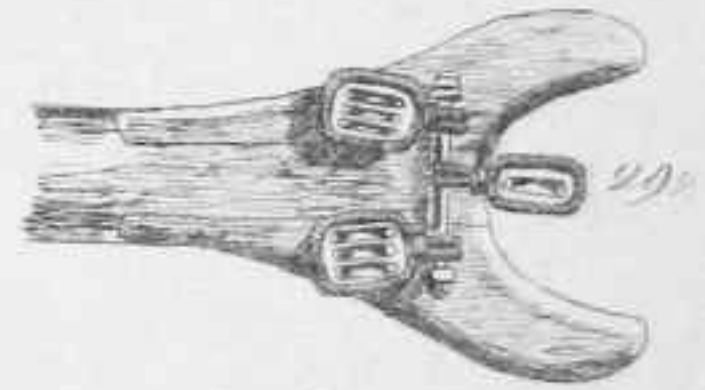
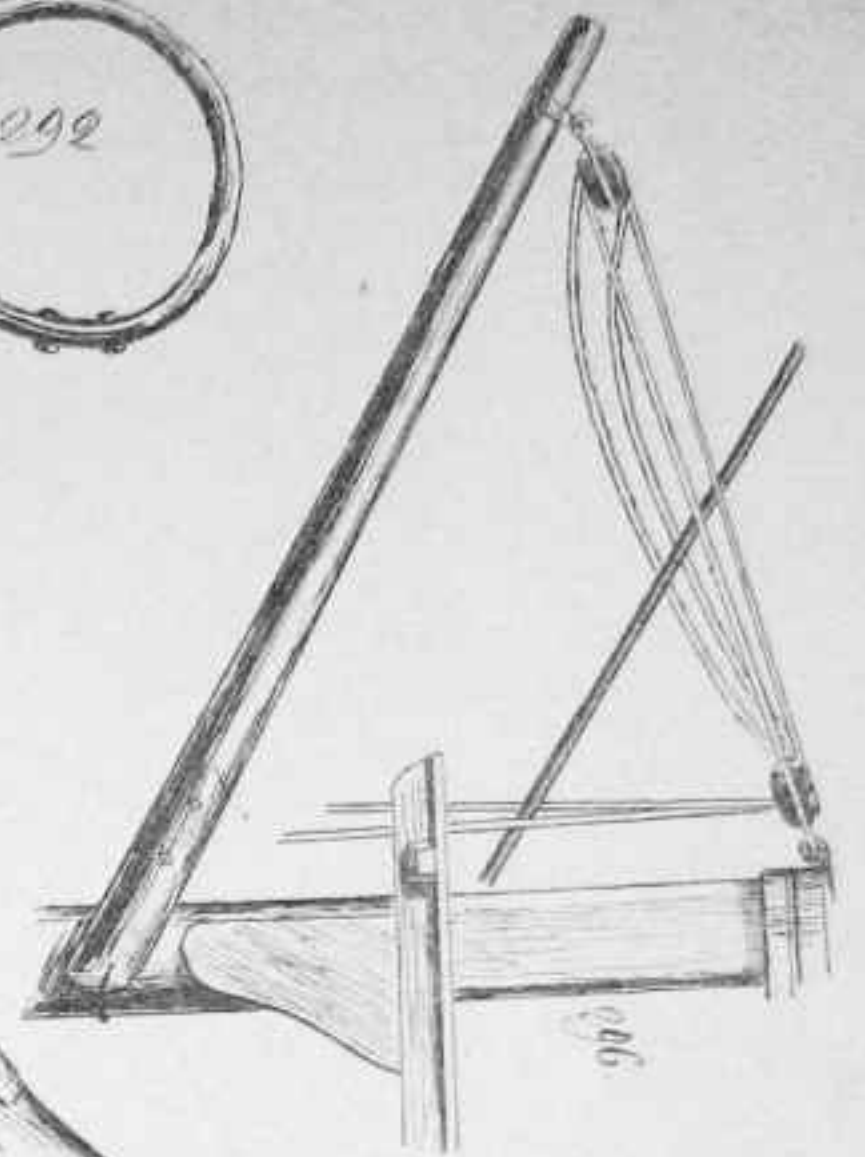
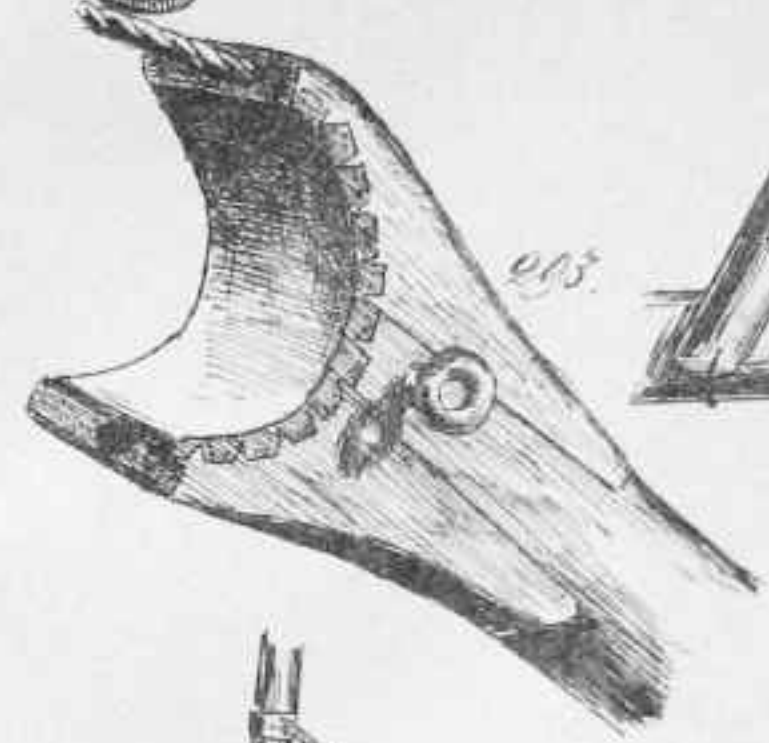
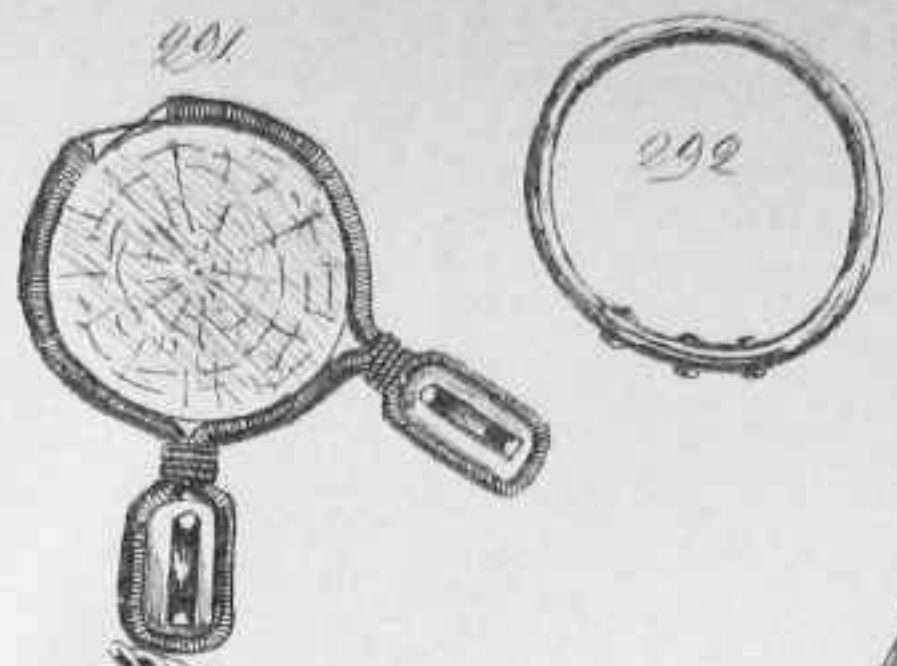
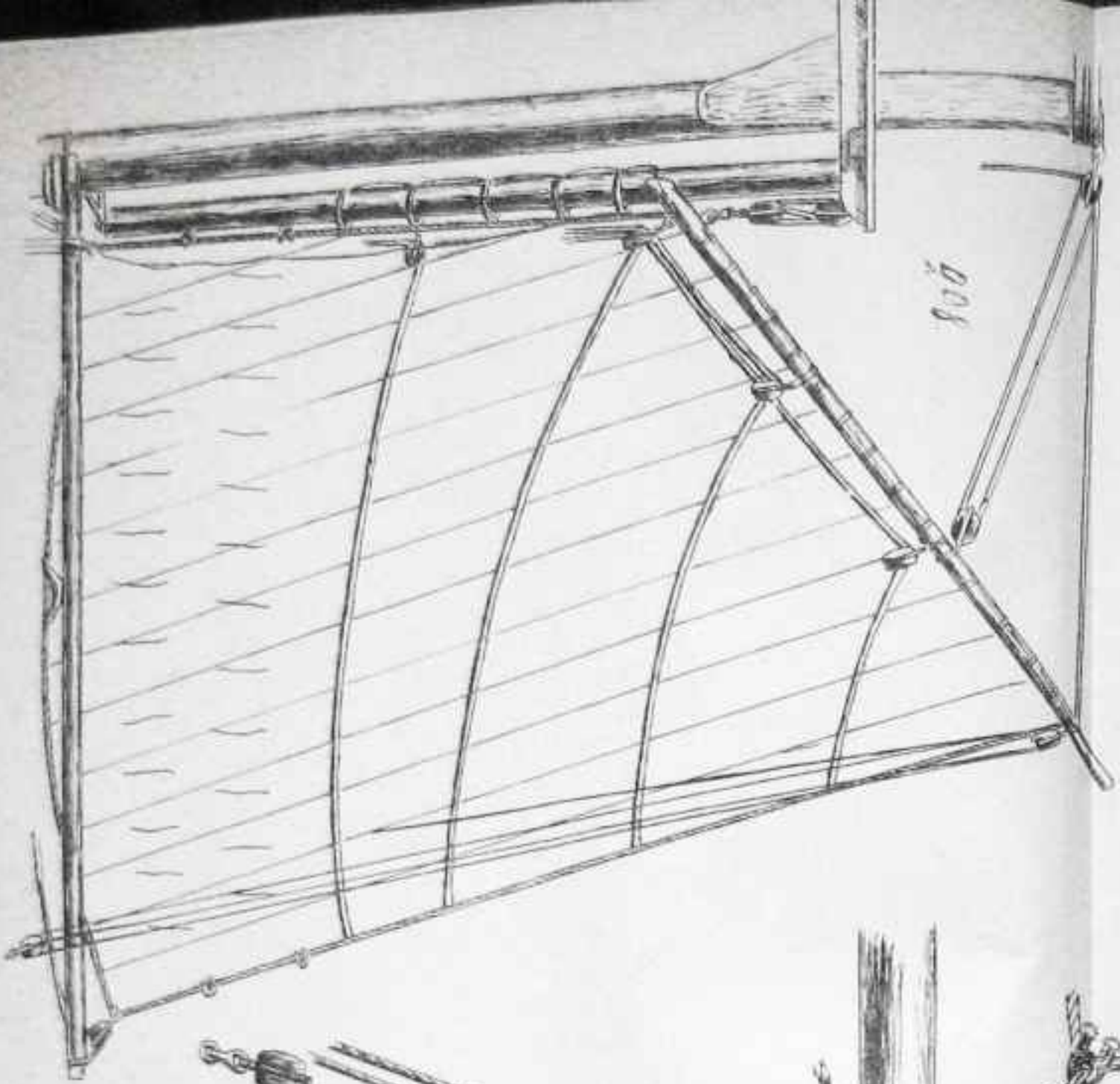

Lucan. 36

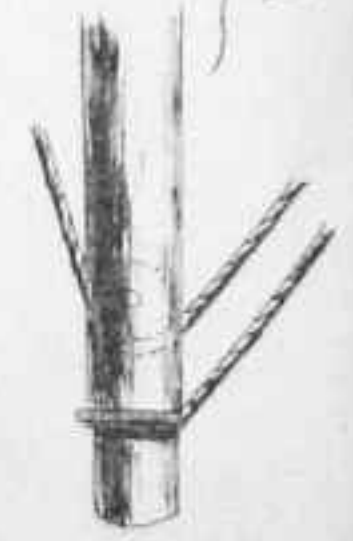
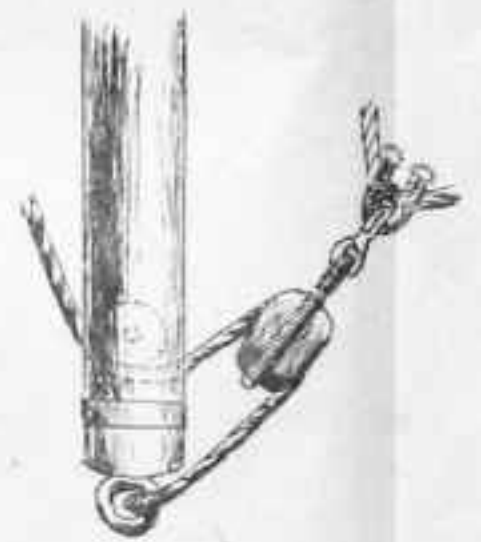
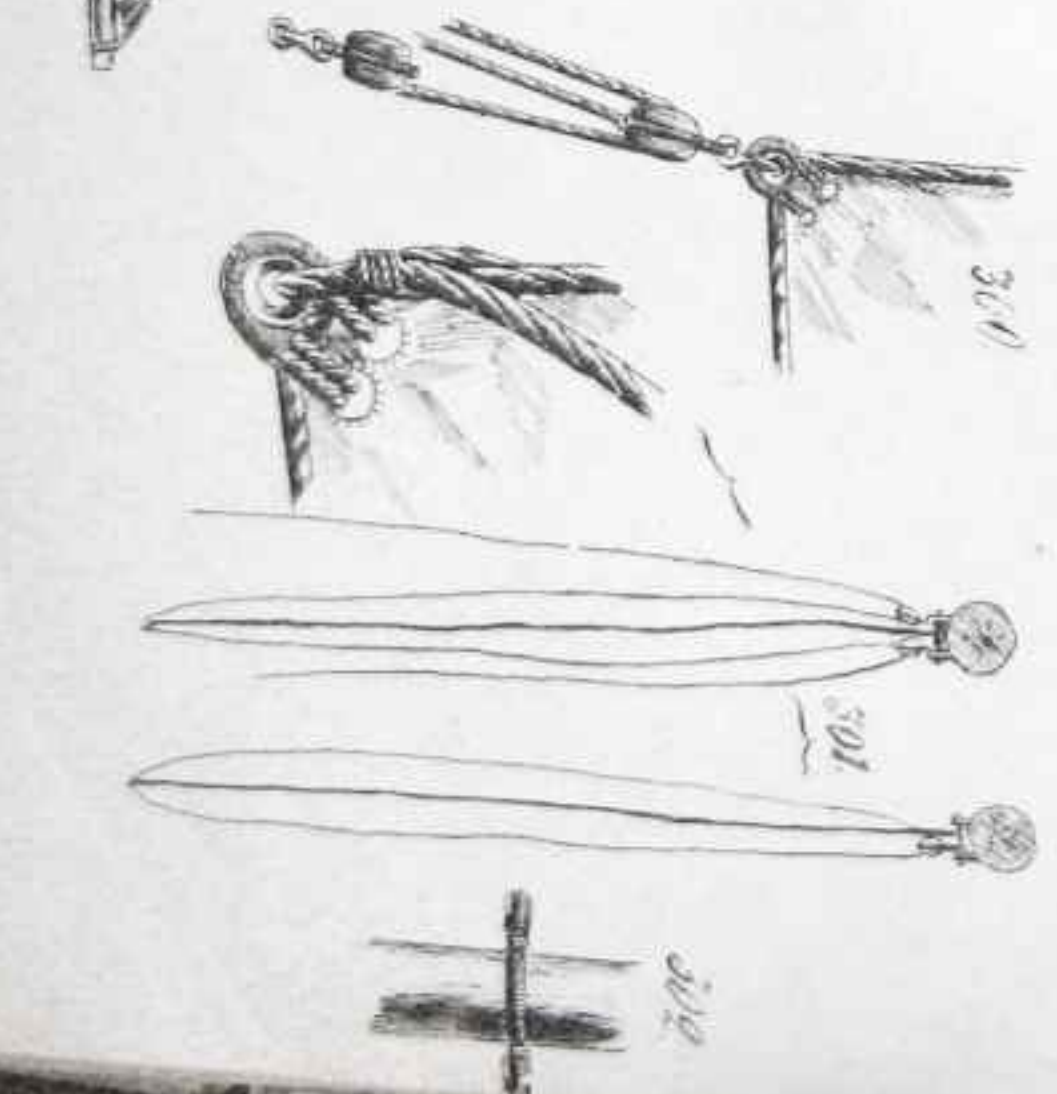

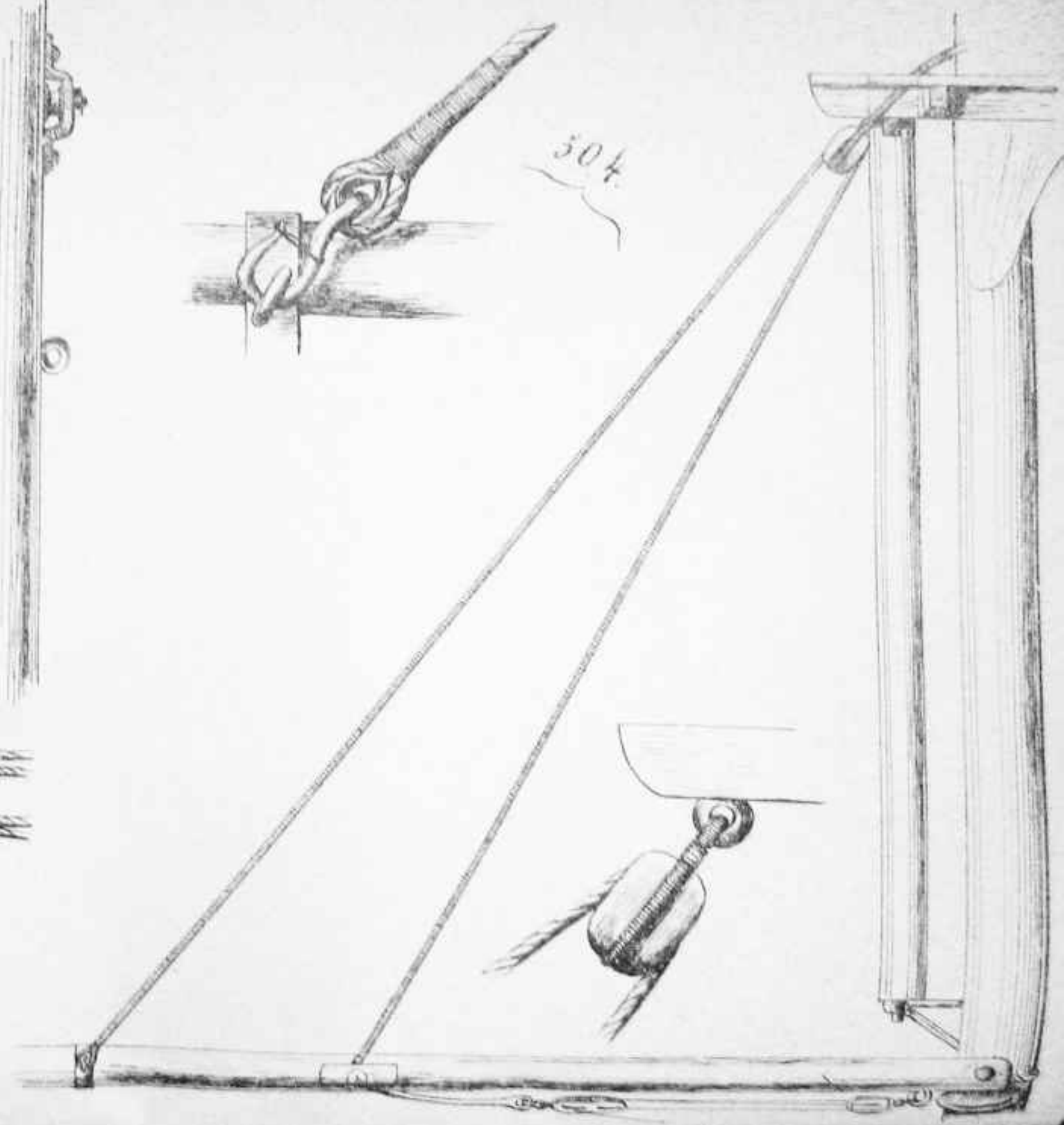
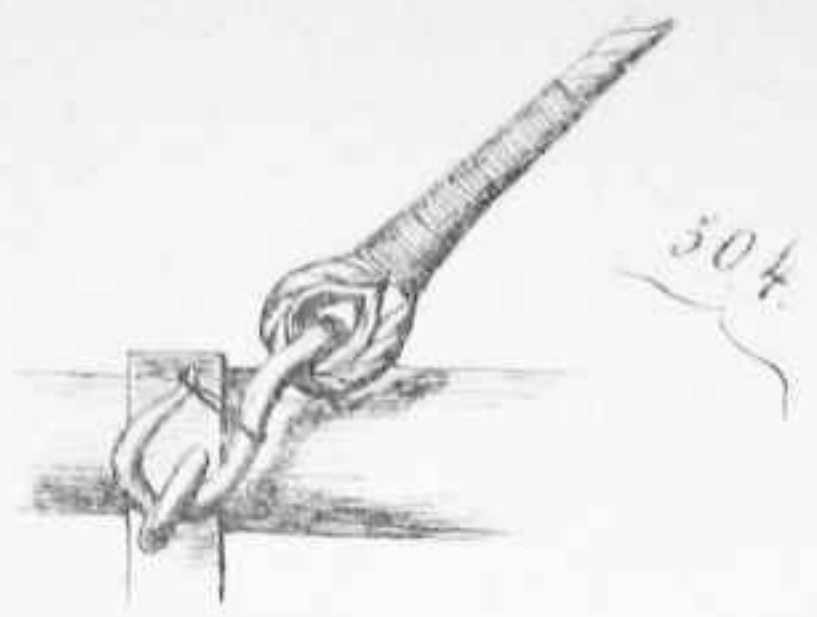
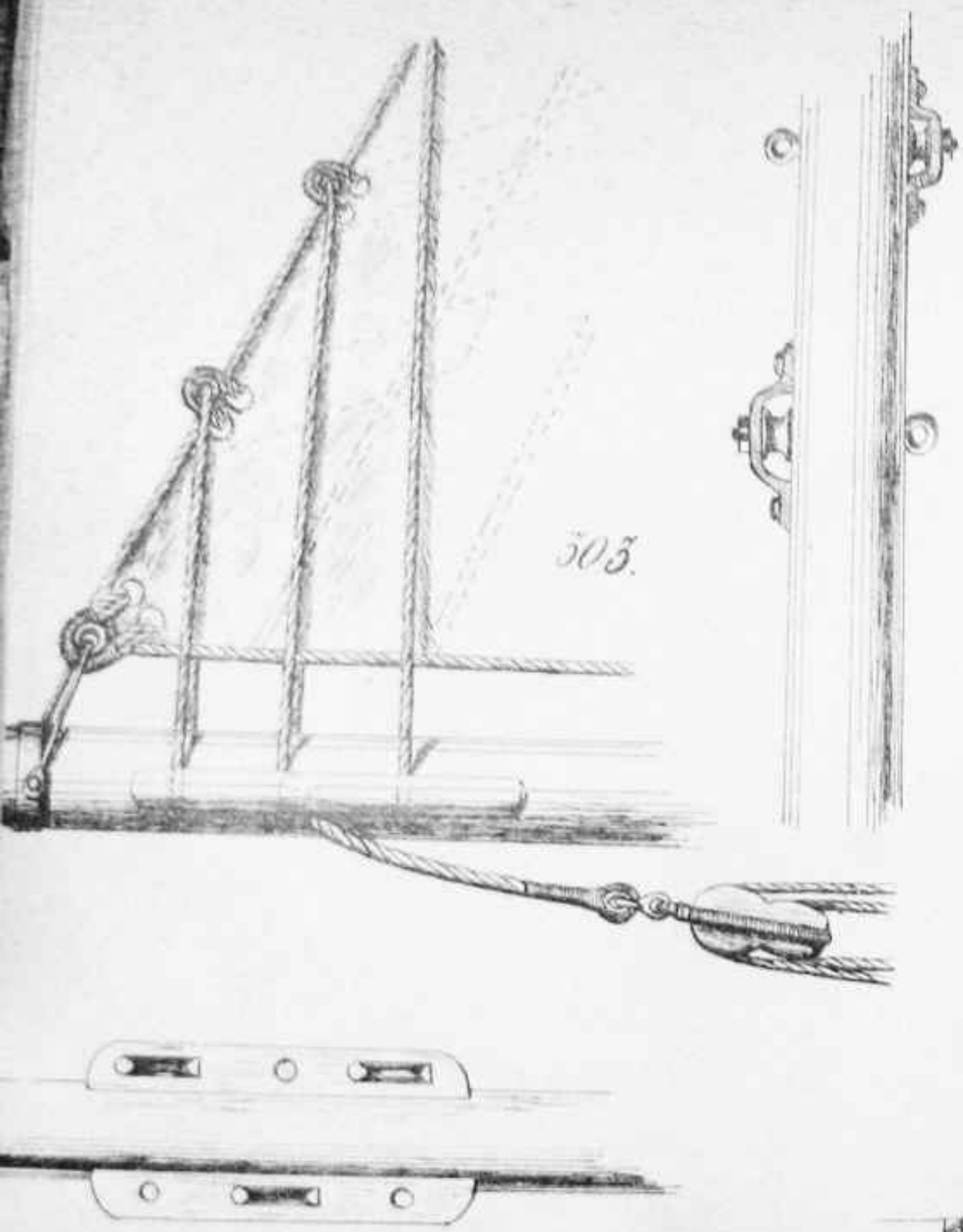

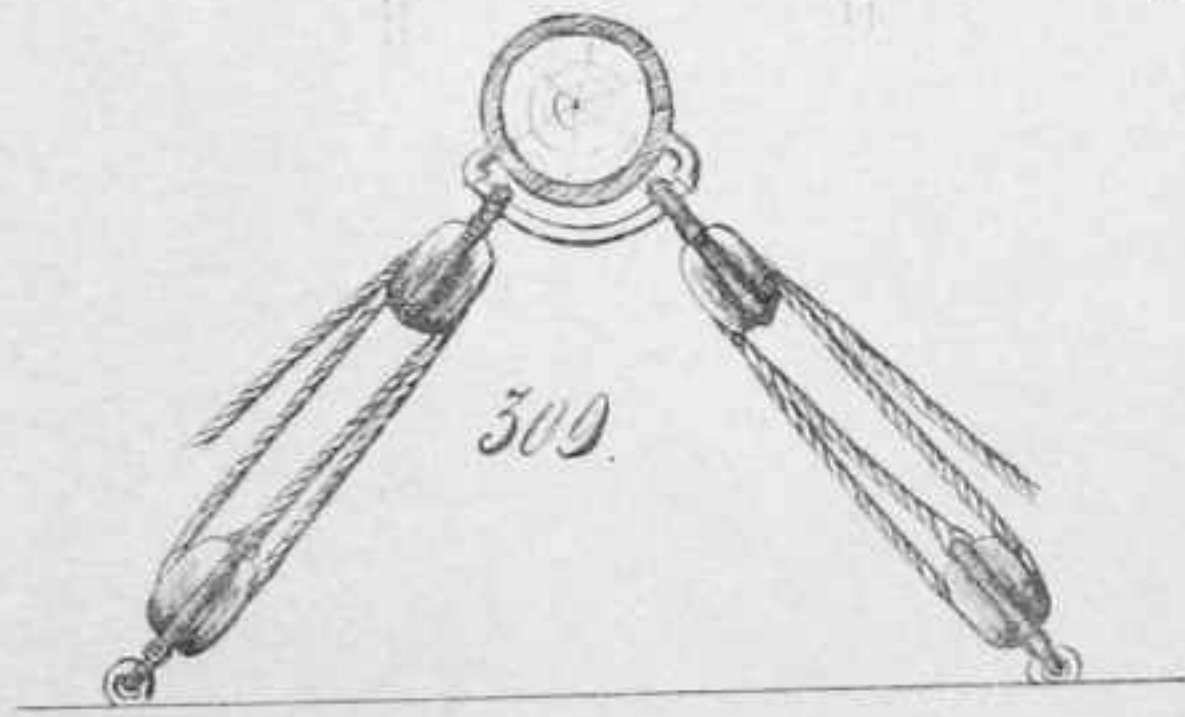
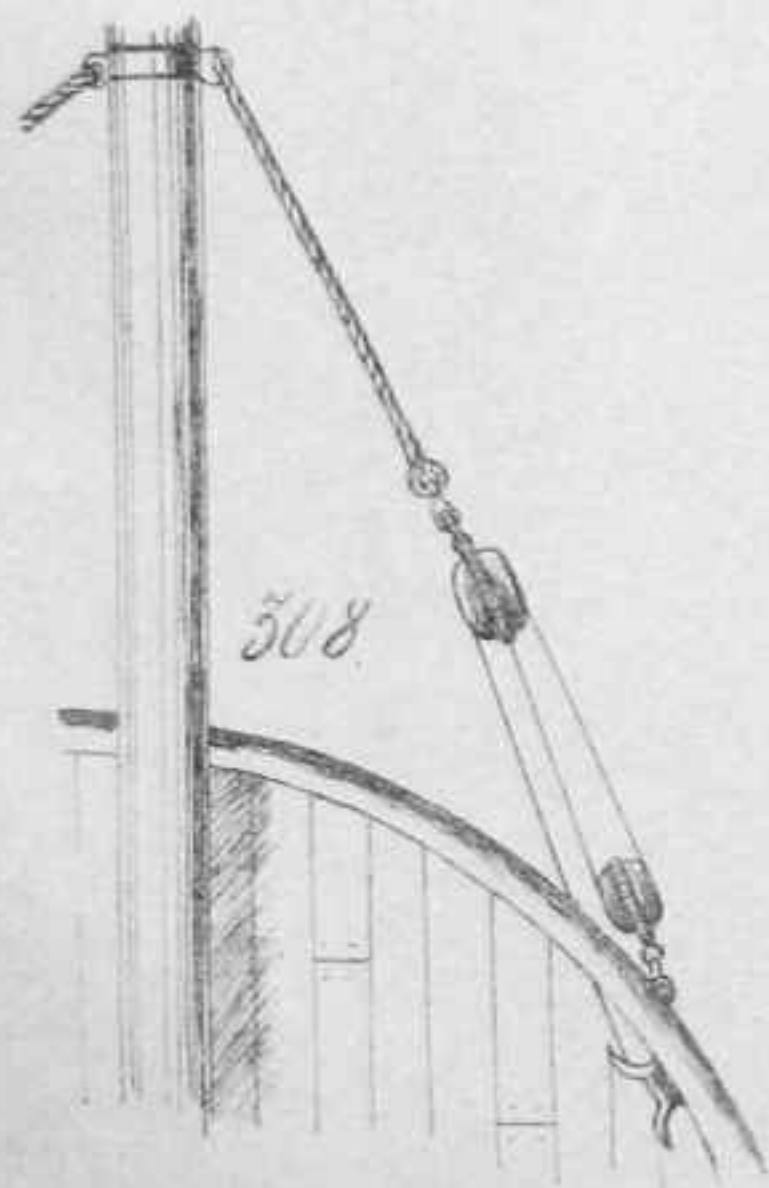
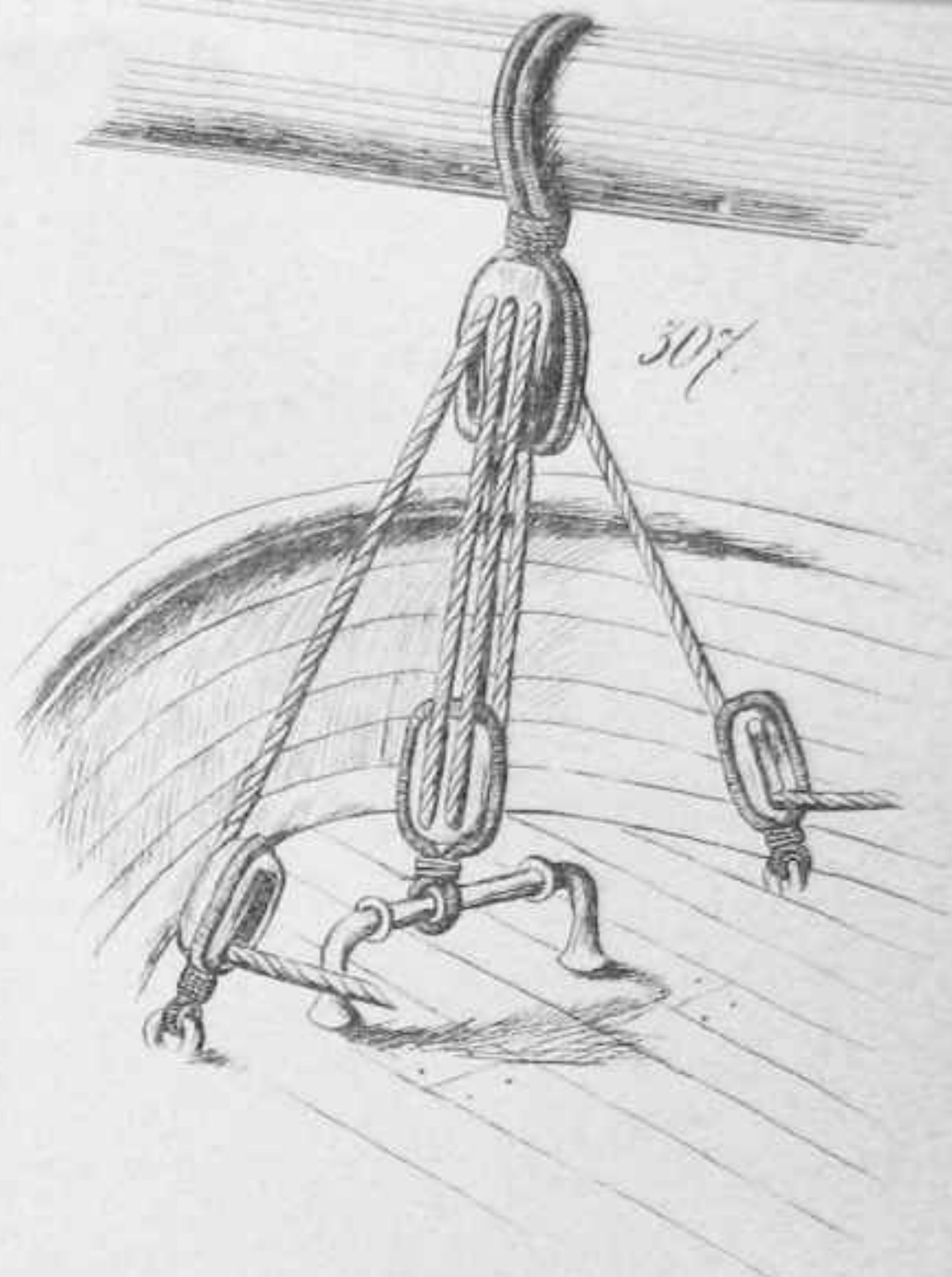
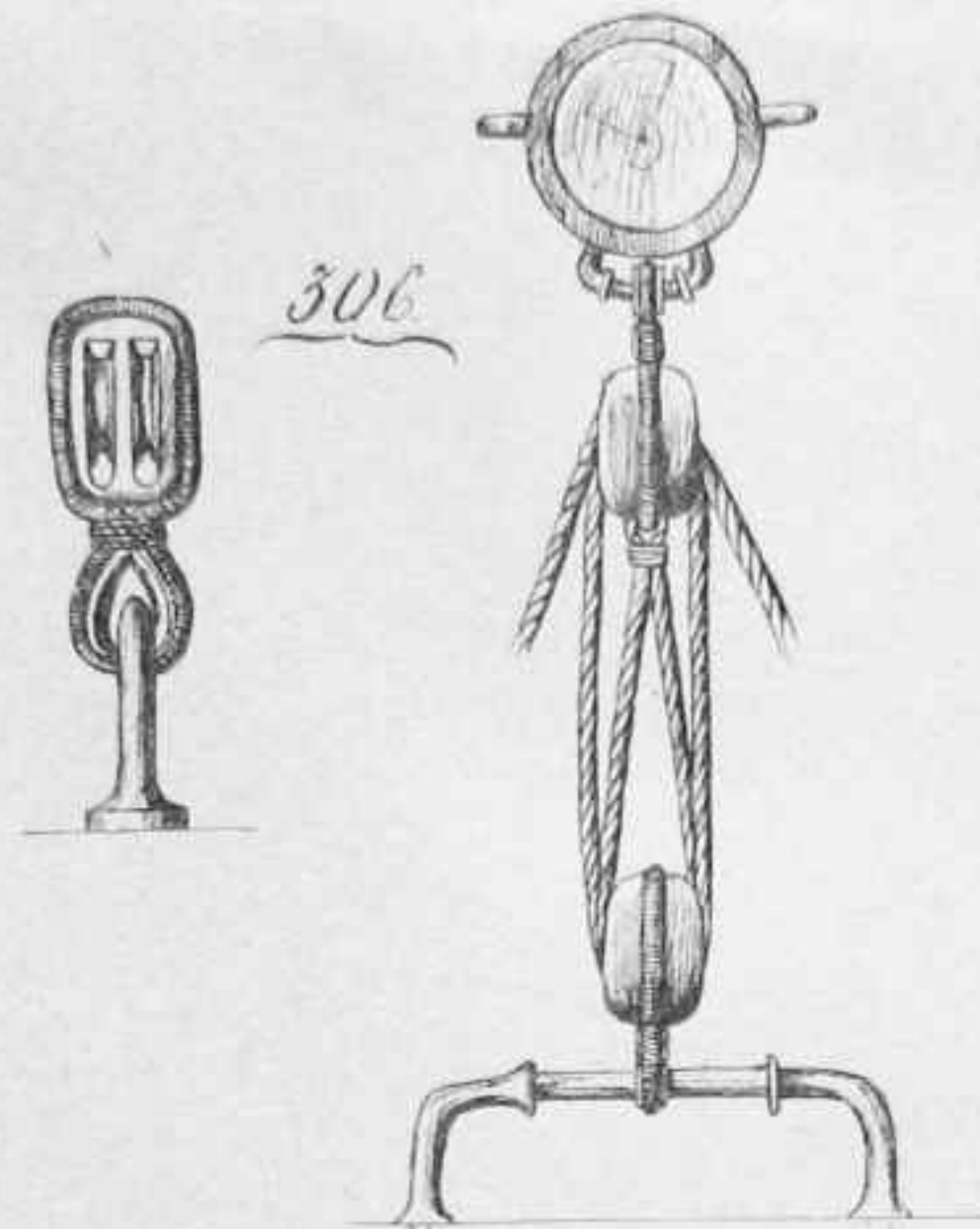
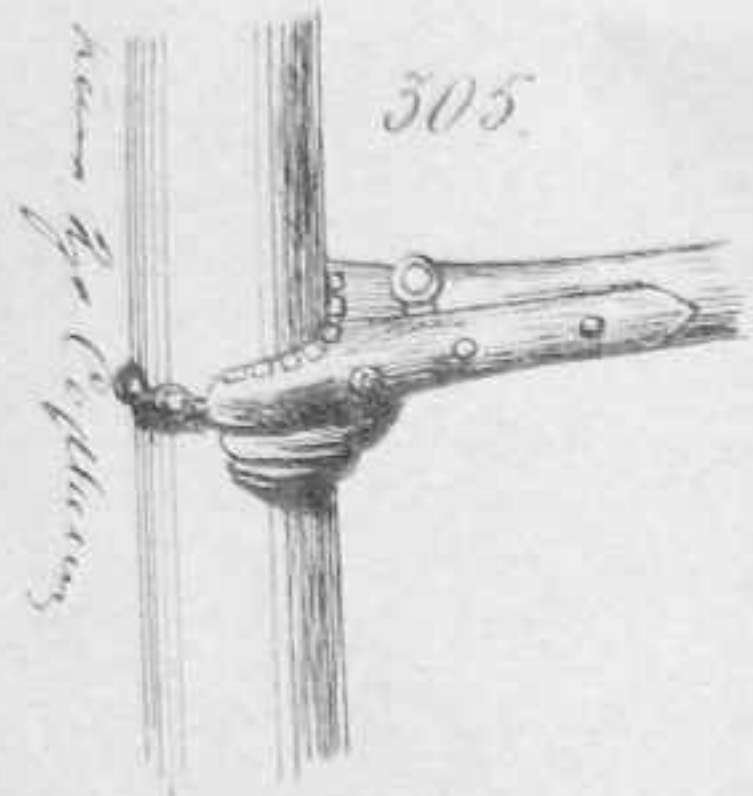

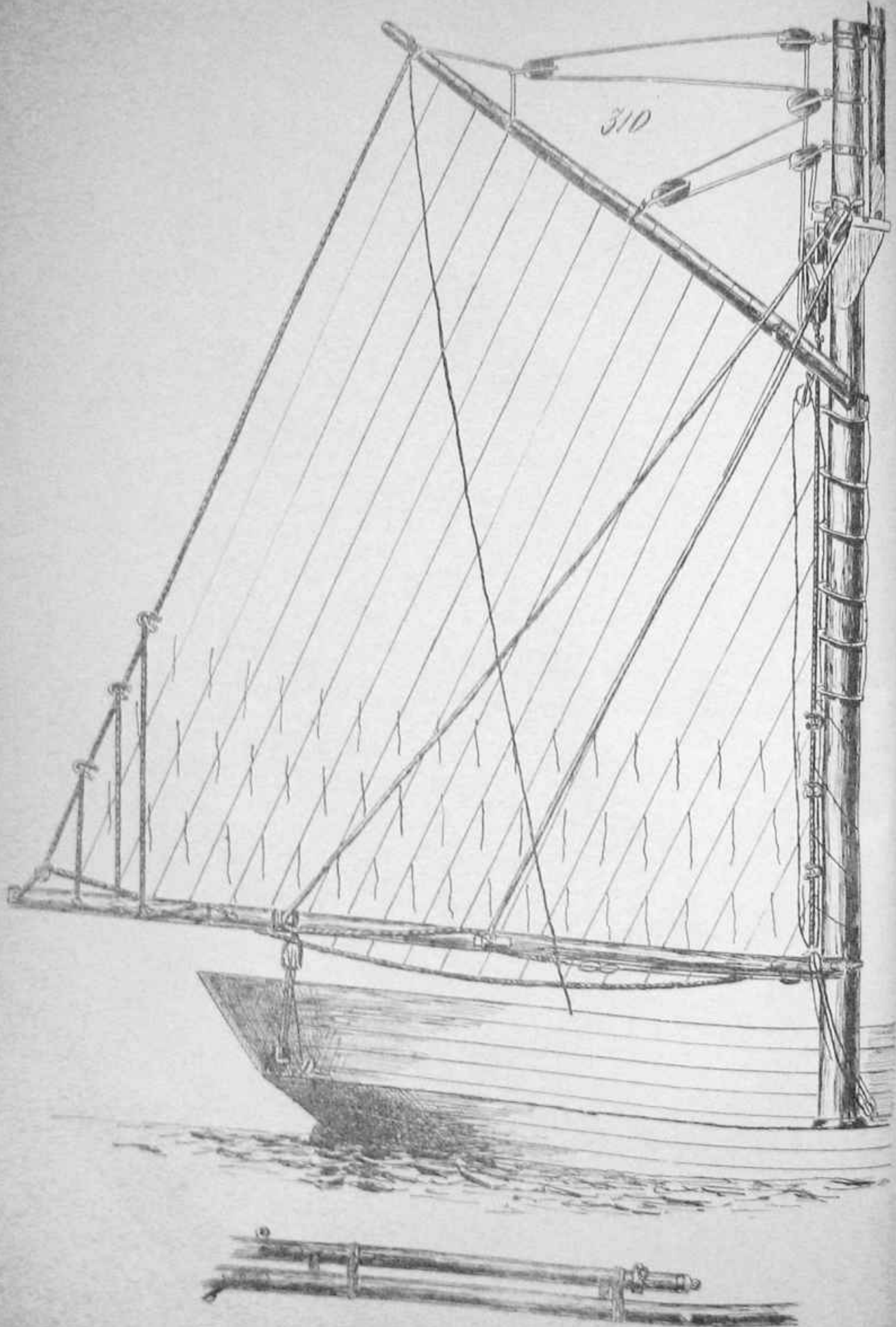

310

11017

311.

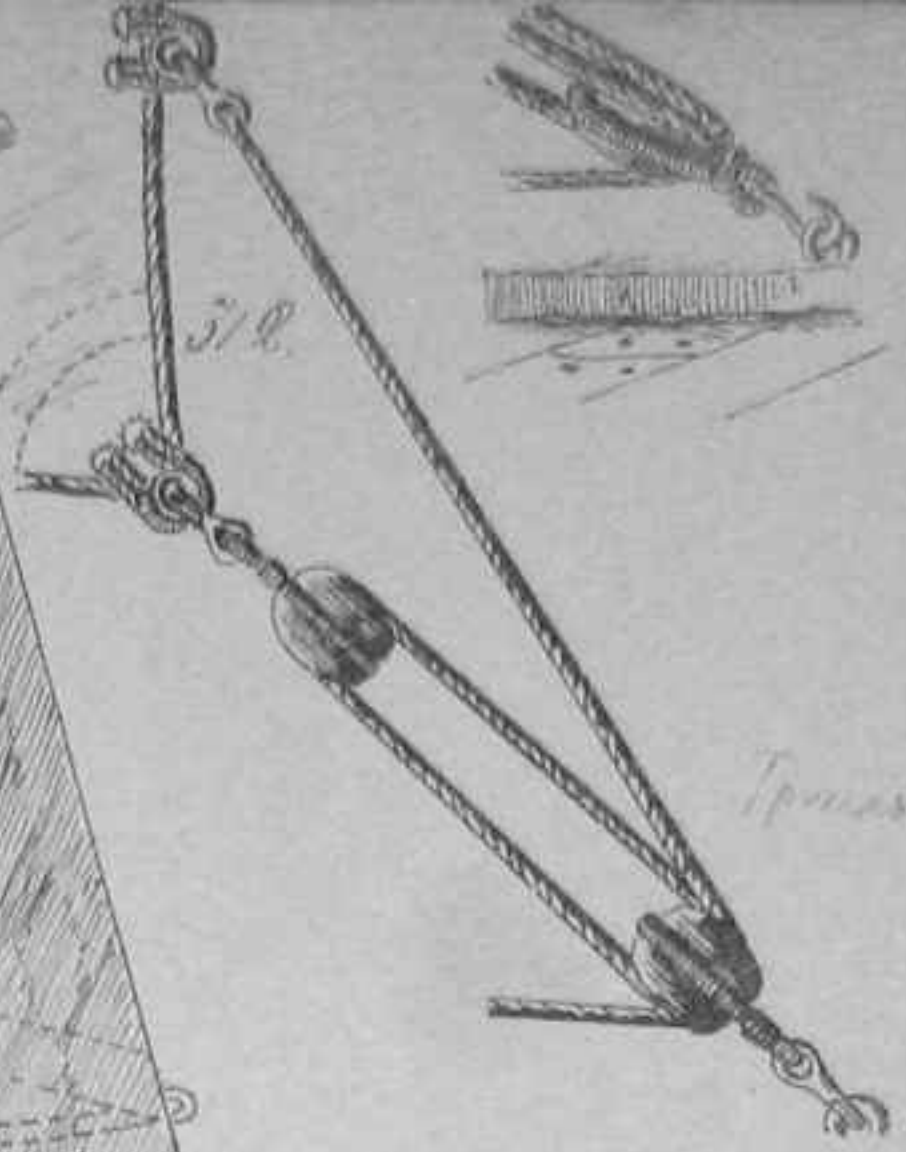
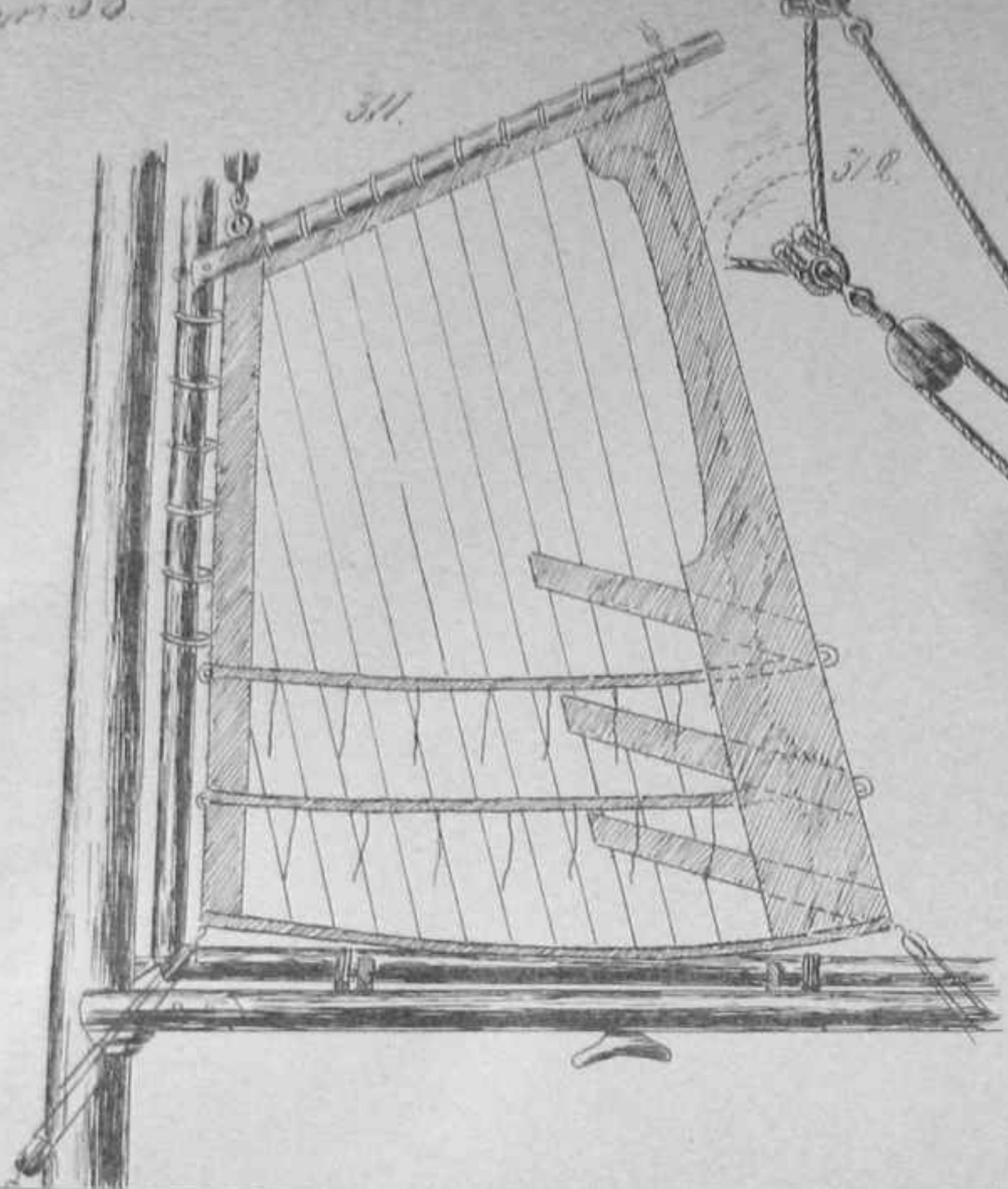

Trousseau

Trousseau - grand

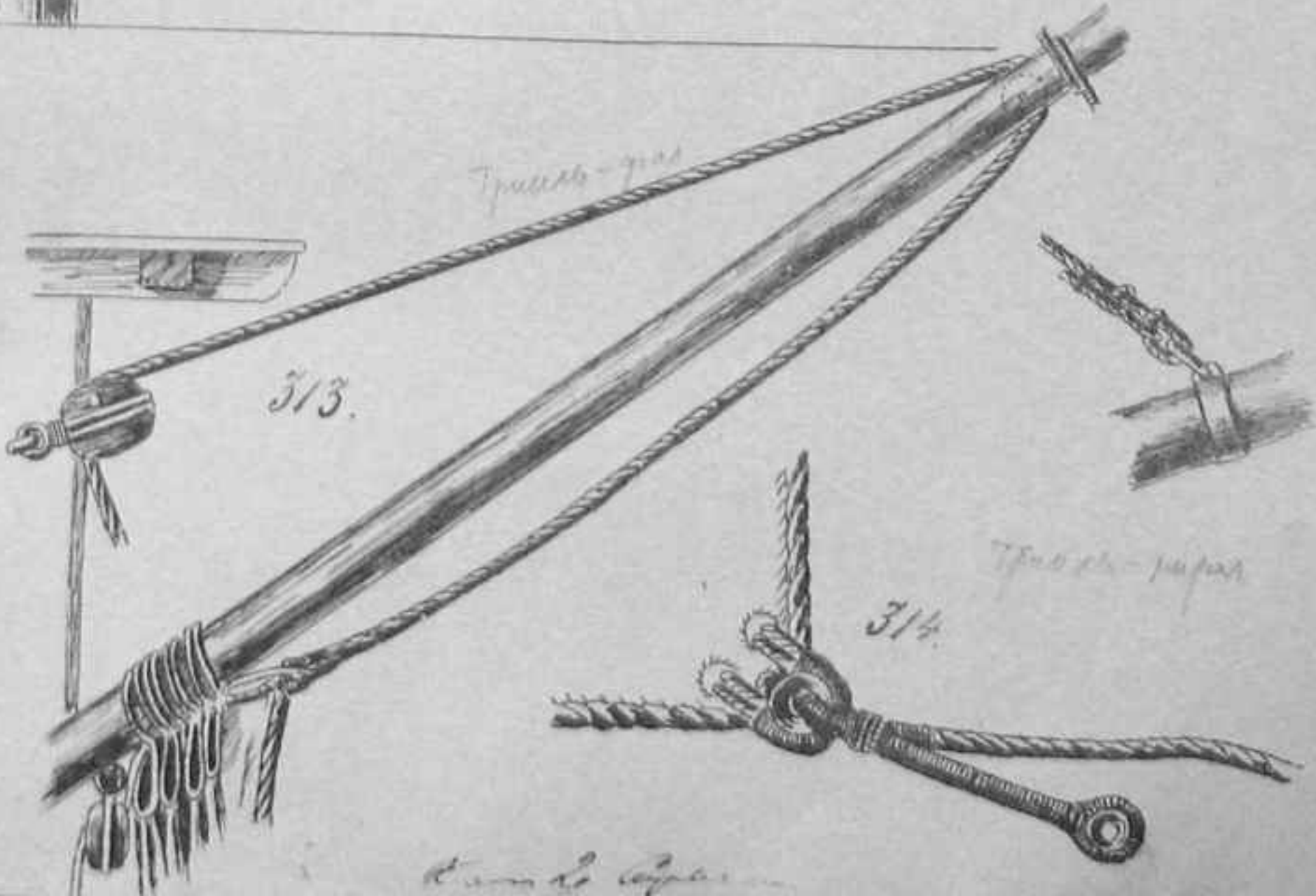

313.

Trousseau - petit

314.

Canot de l'Esperance

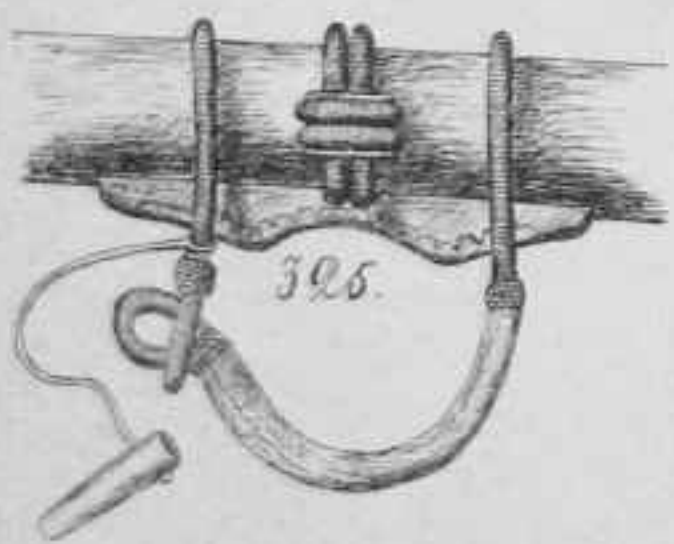
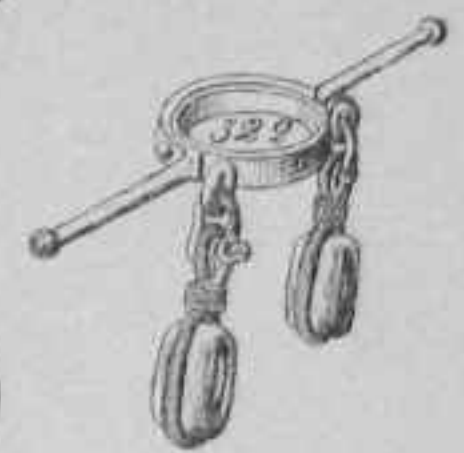
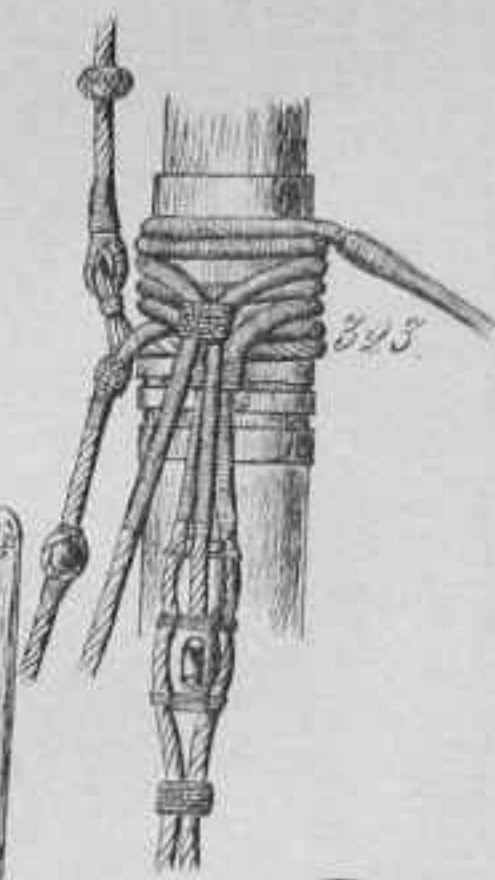
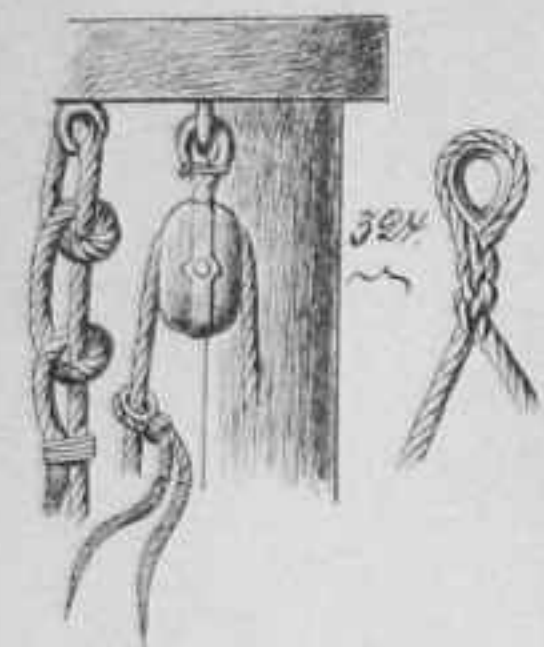
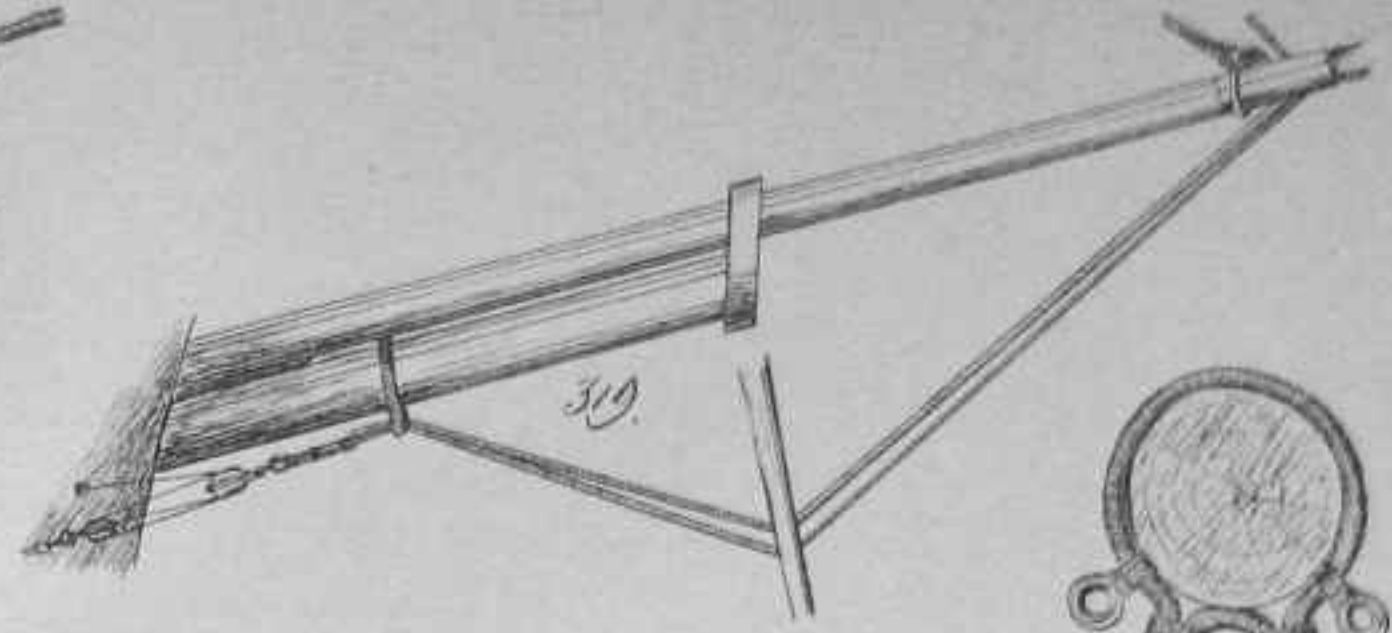
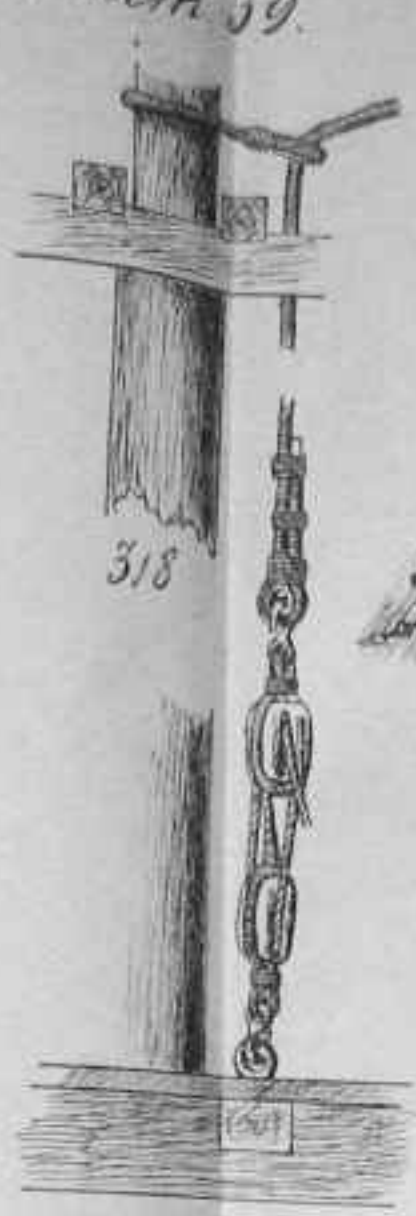
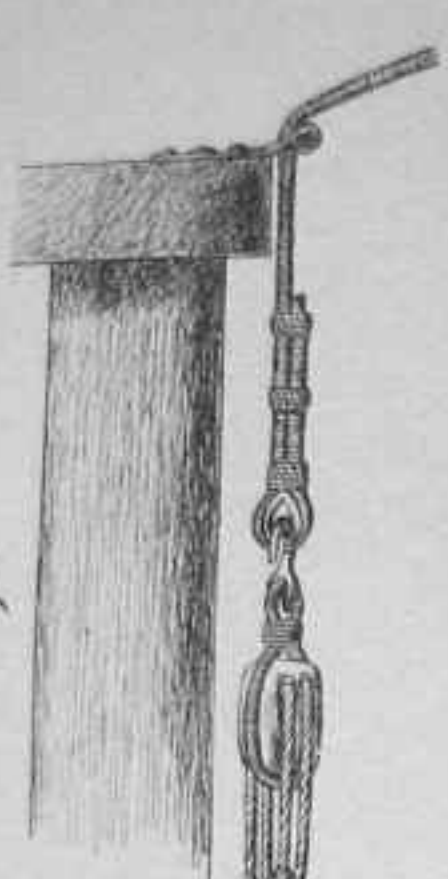
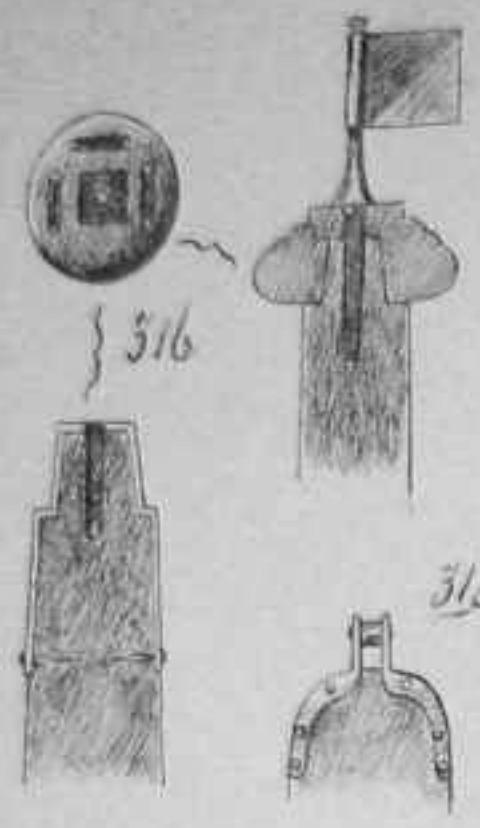
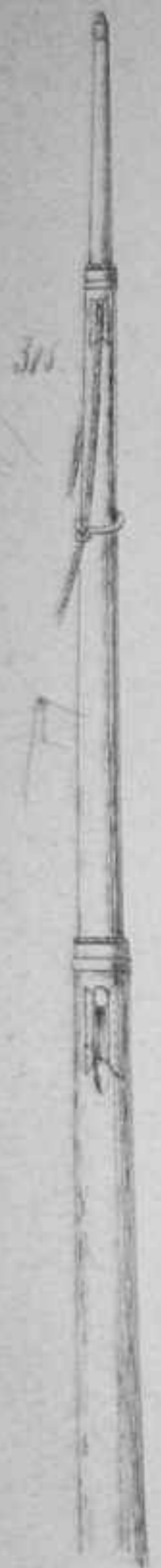

327

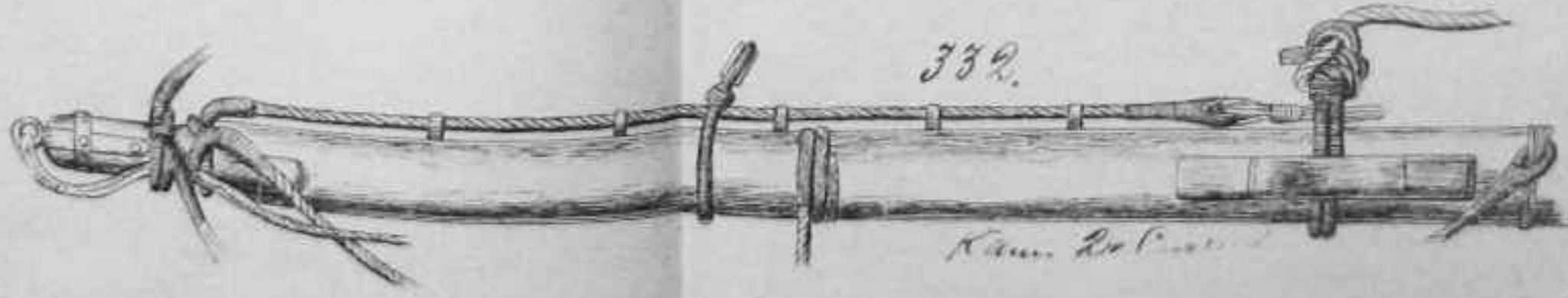
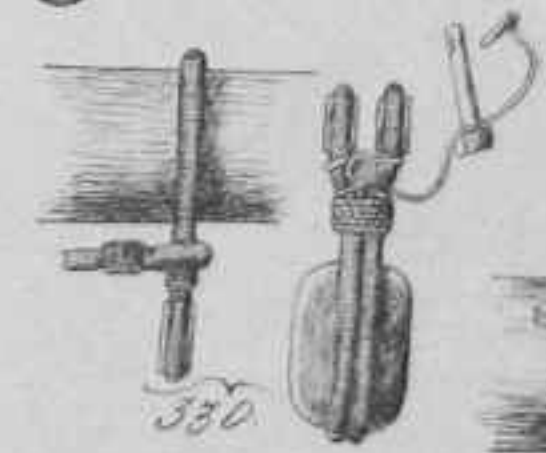

332

Lucern. 40.

353.

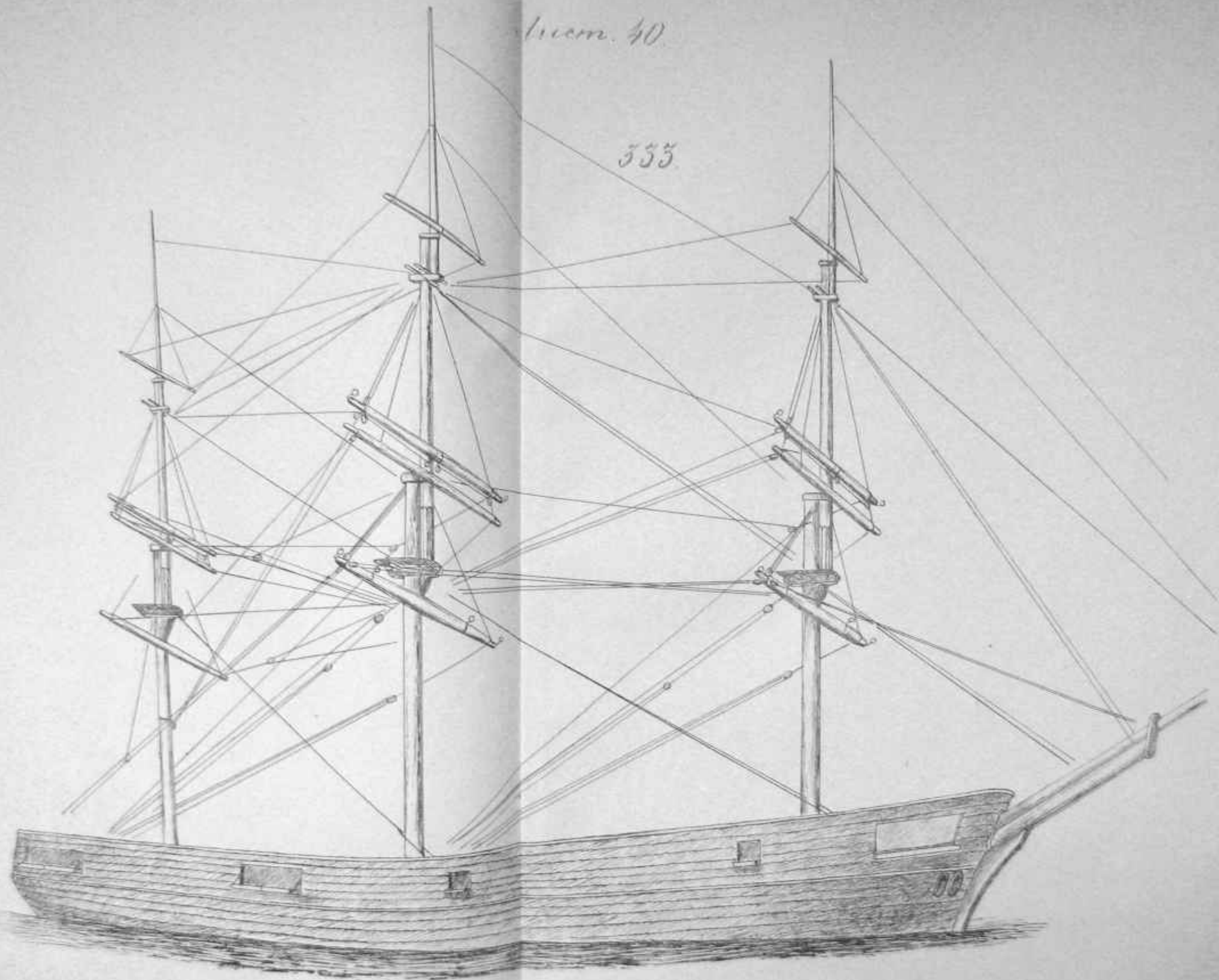

Num. 71.

334.

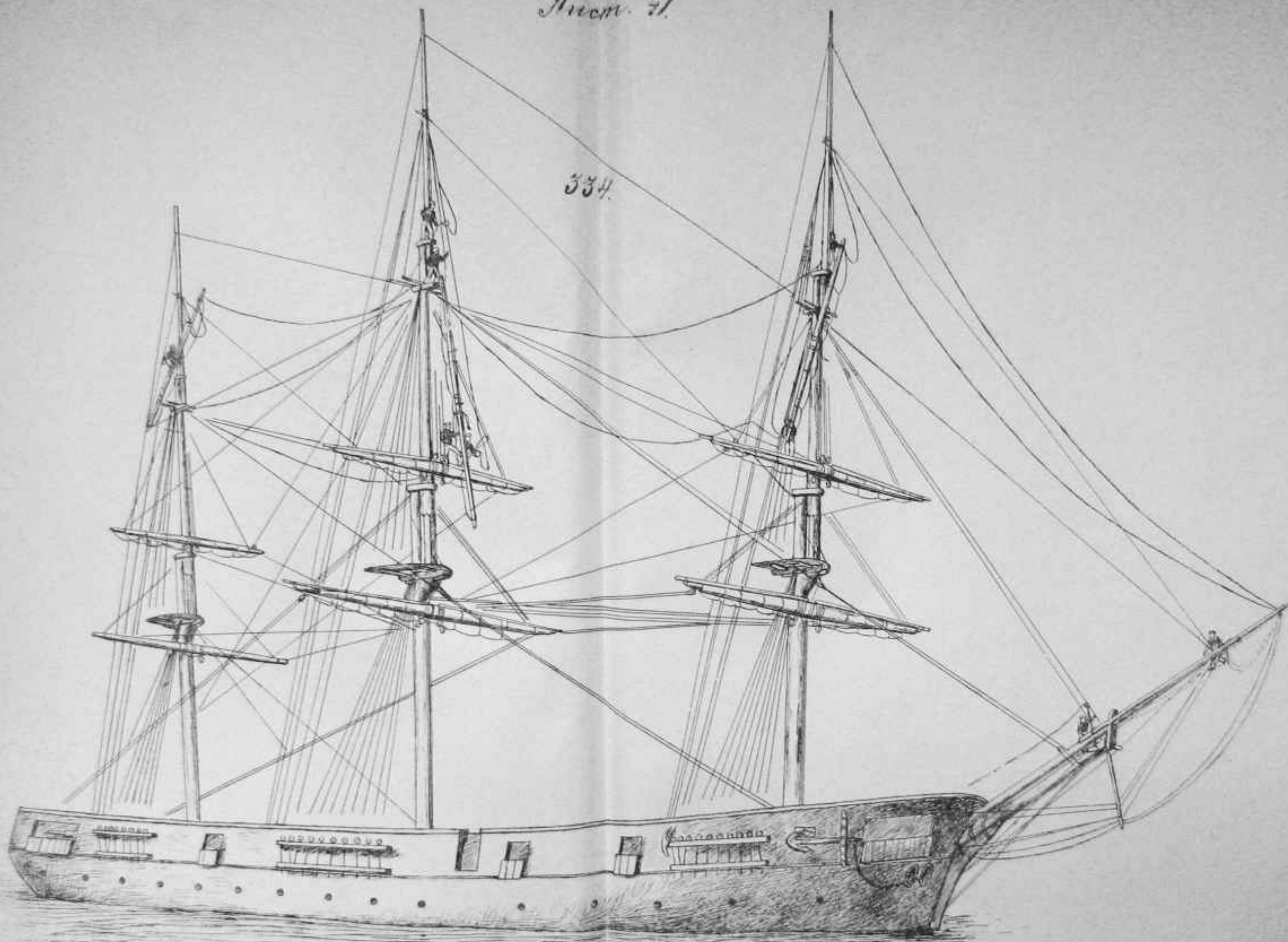

From the Captain

Pluch 49.

335

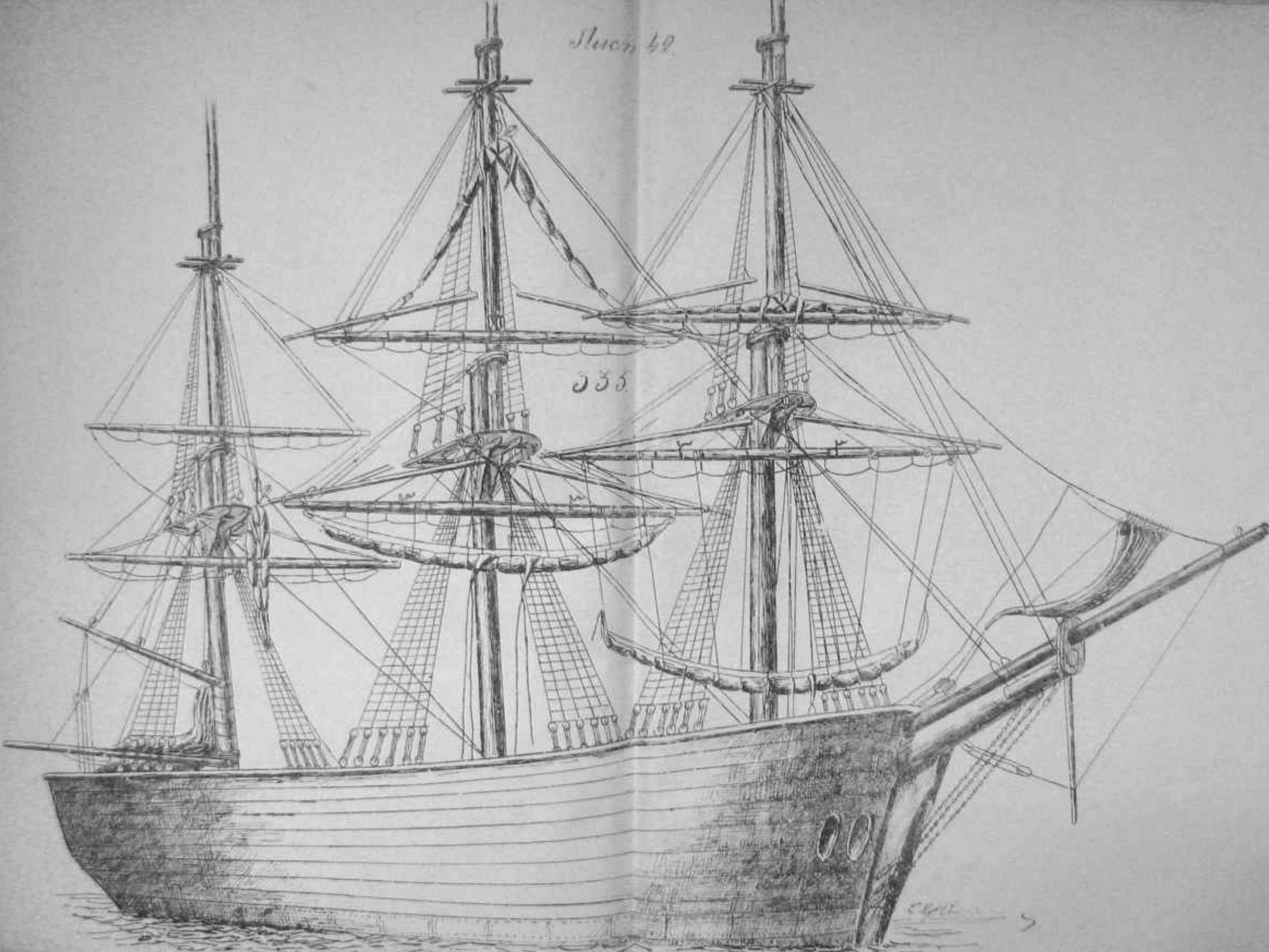

Curry

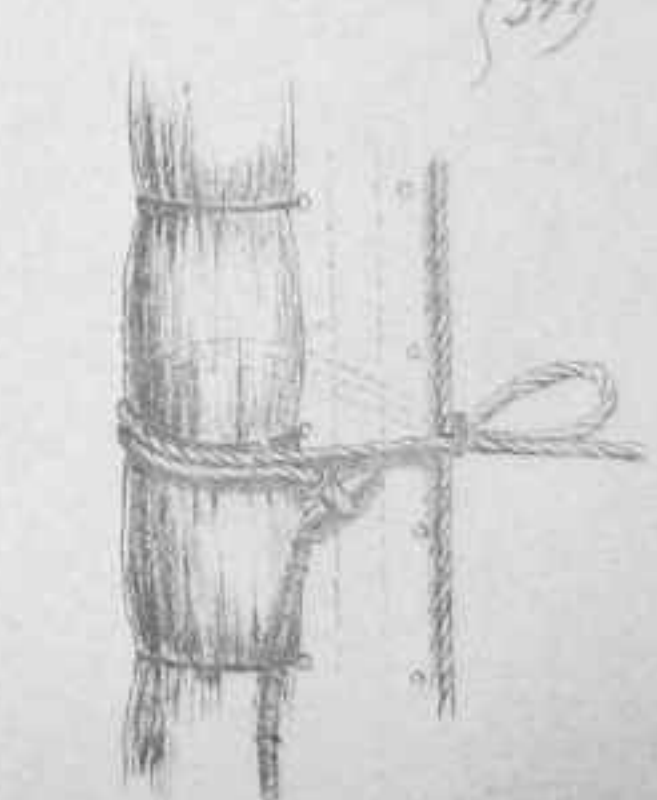
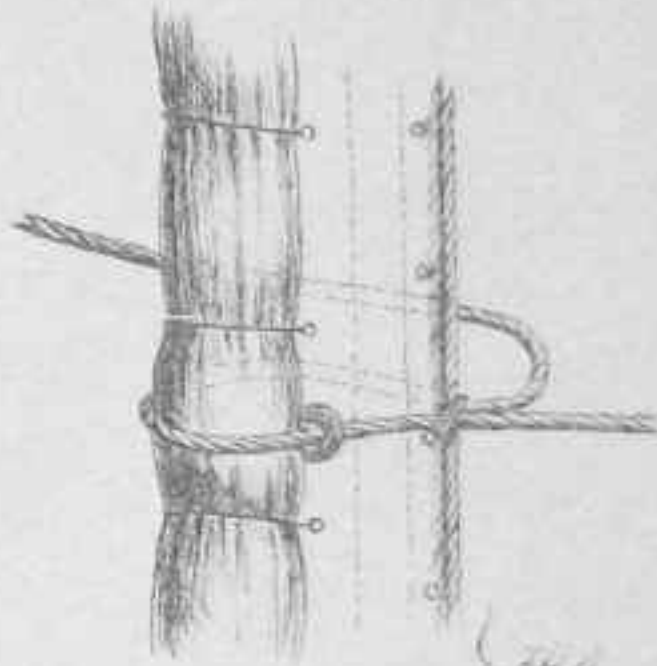
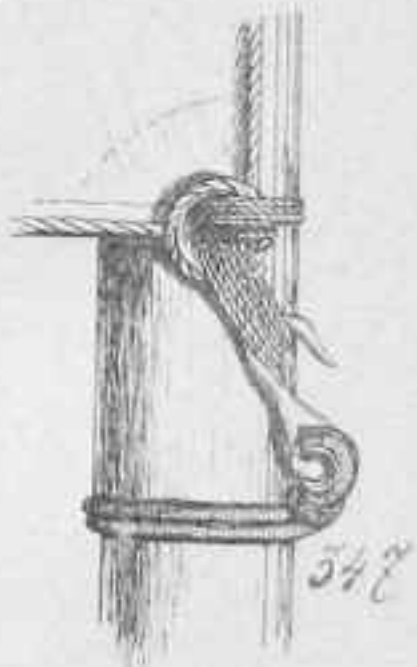
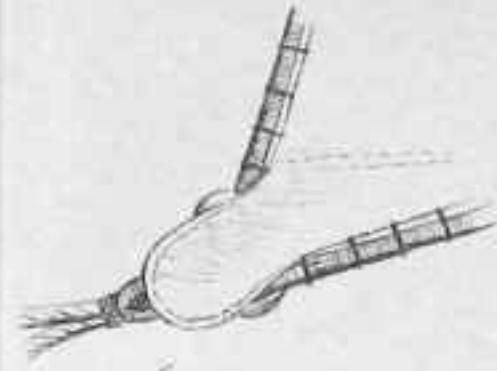
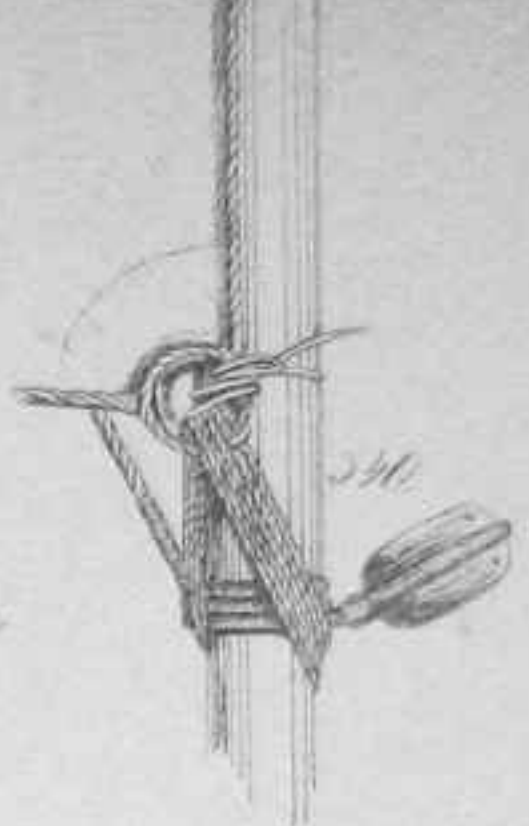
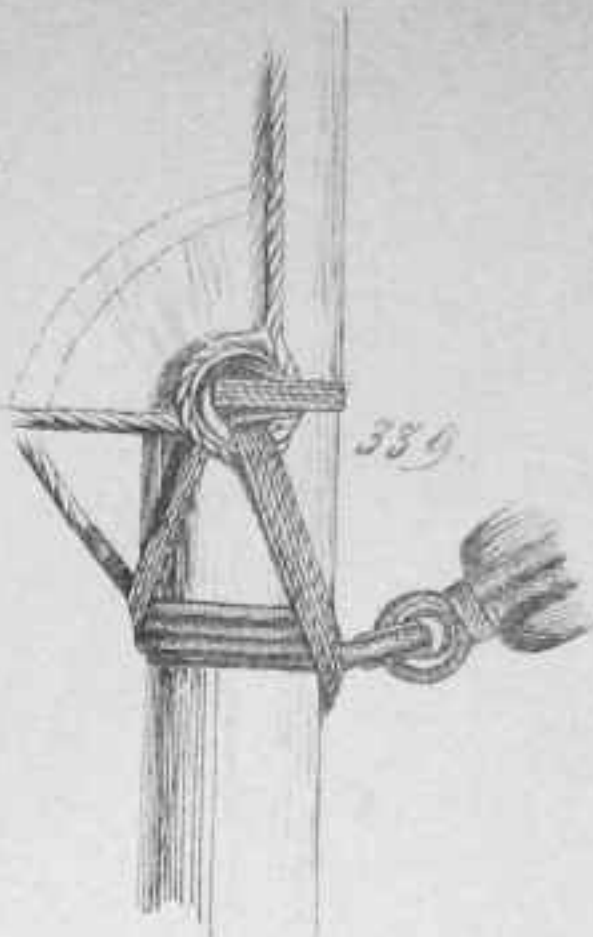
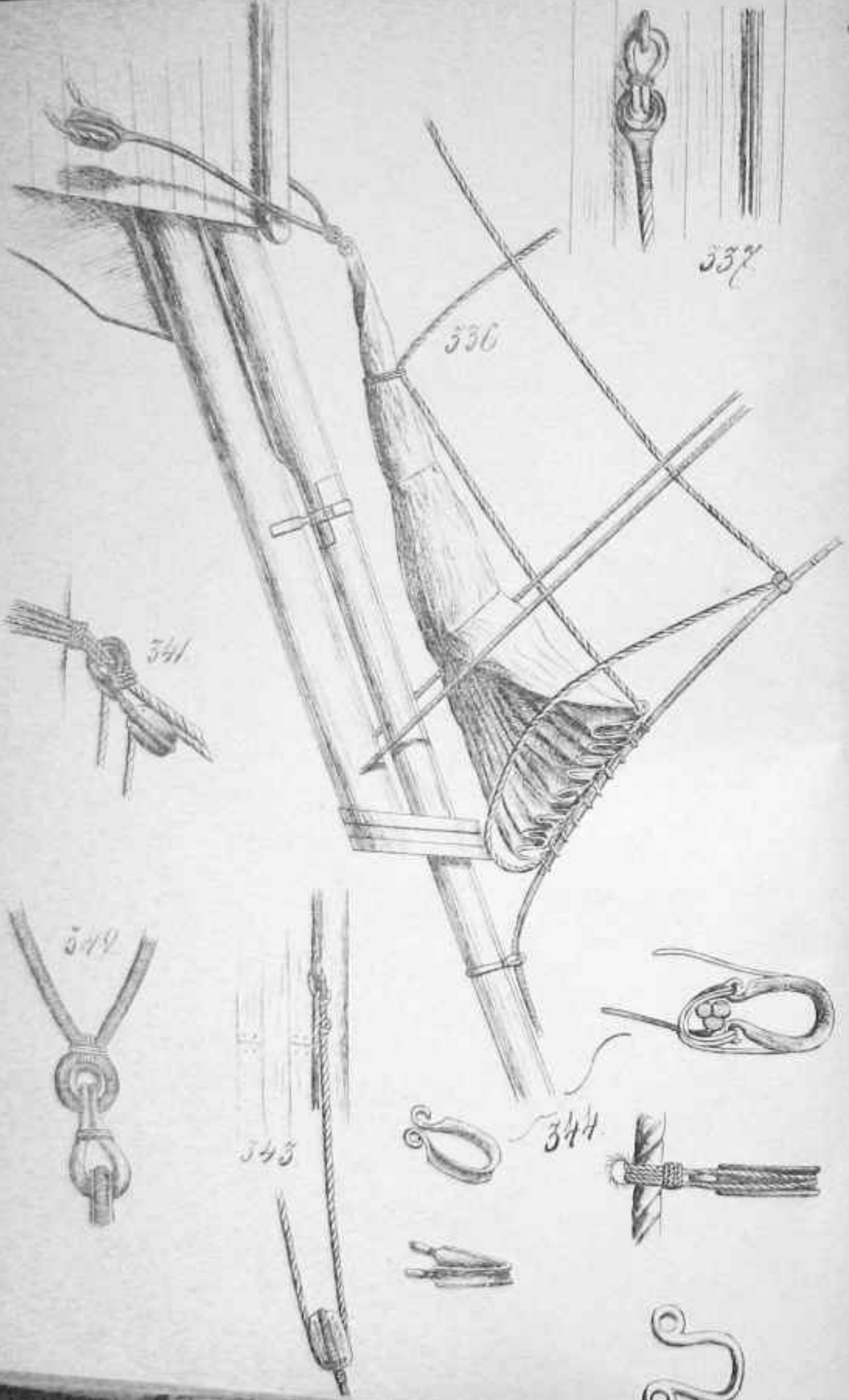

Handwritten text at the bottom of the page, possibly a signature or a note.

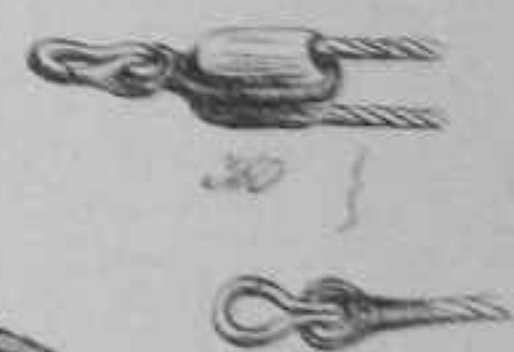
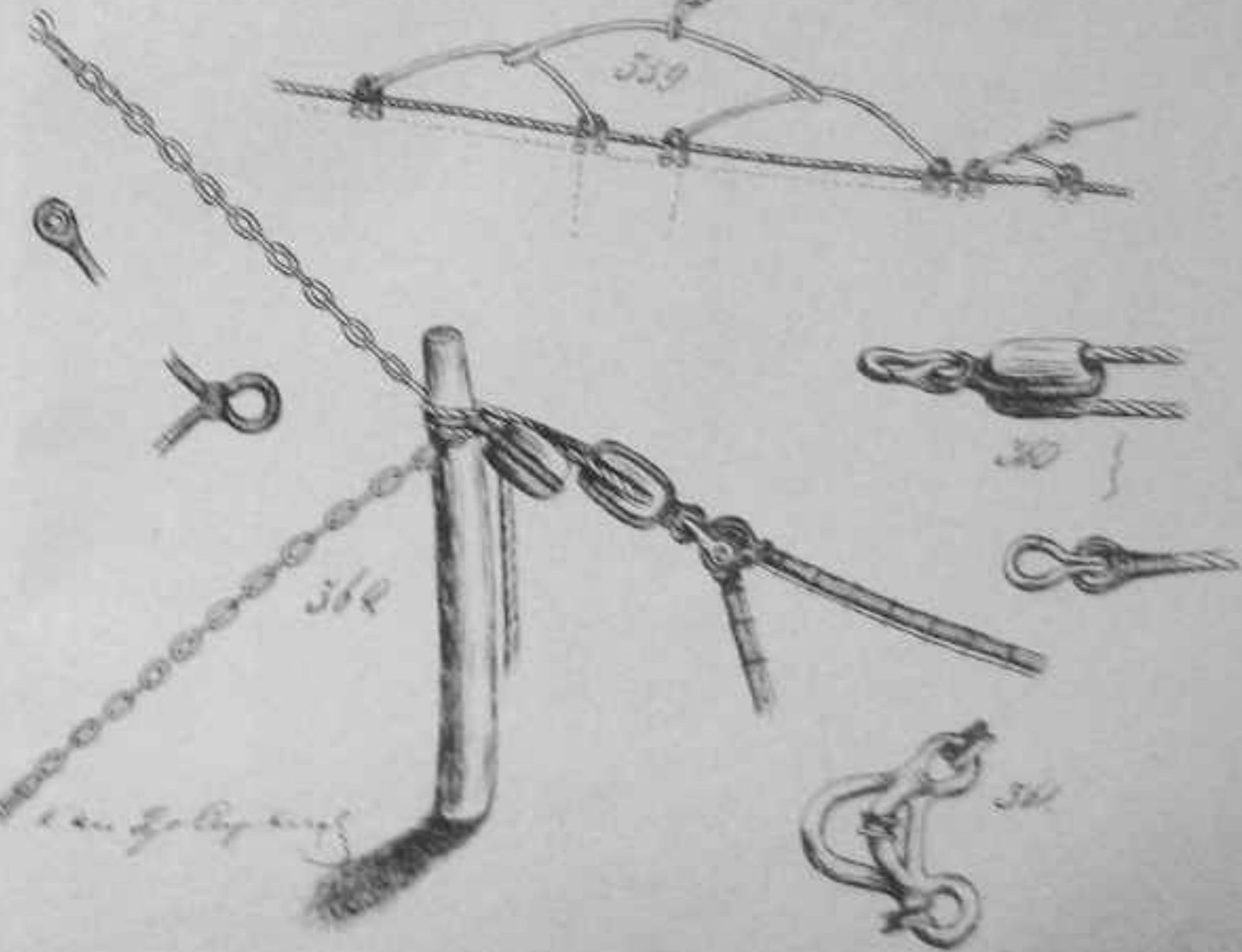
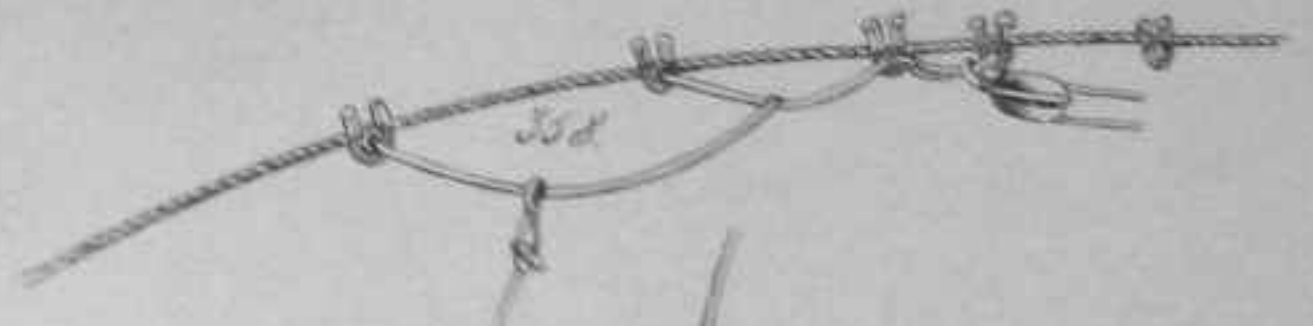
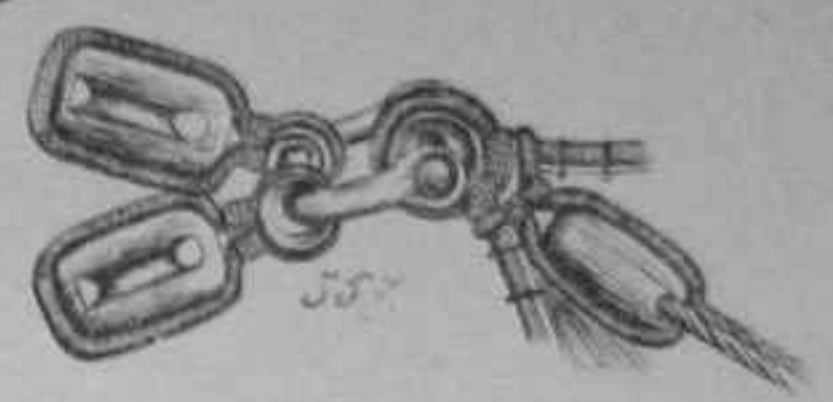
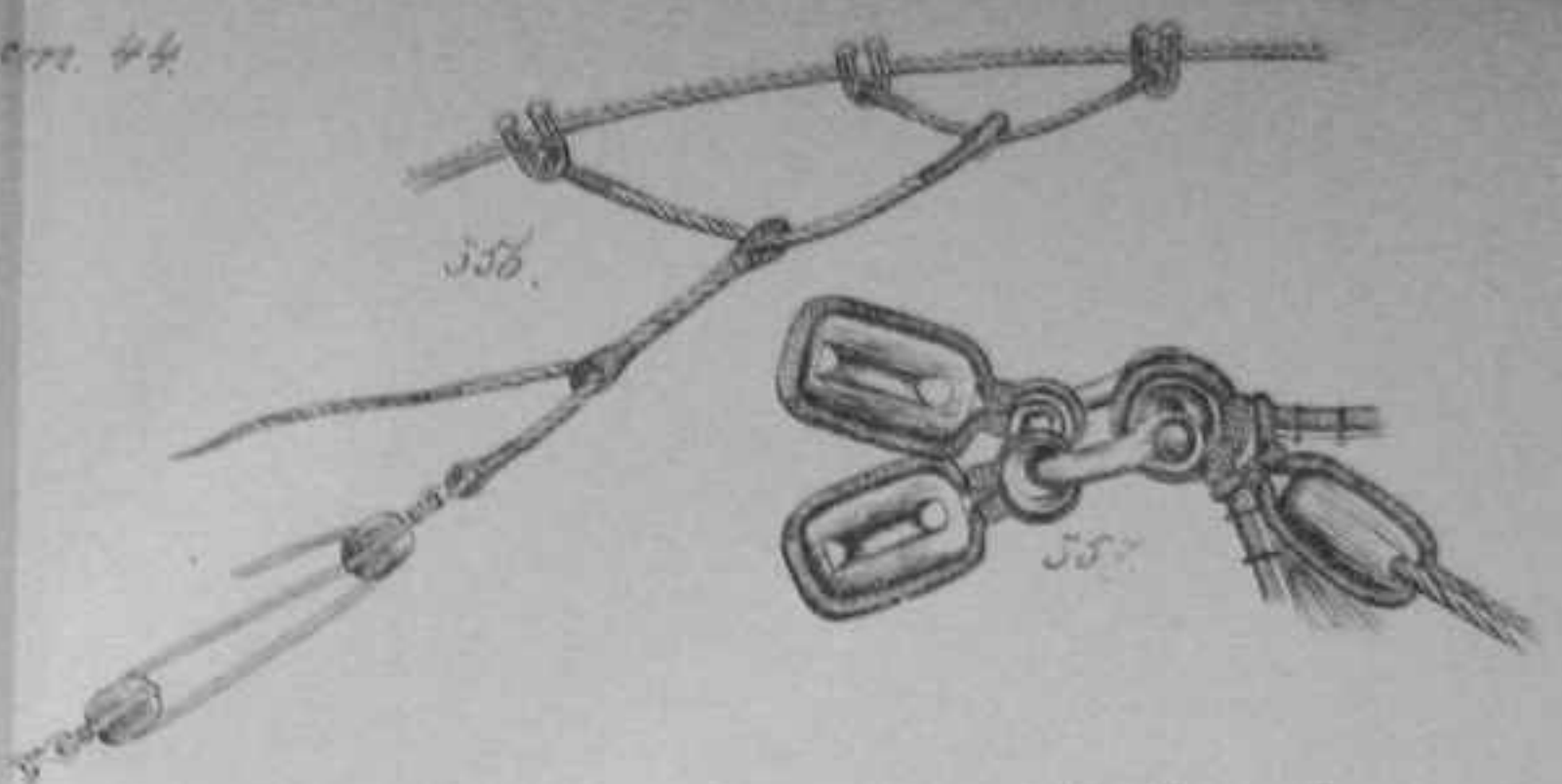
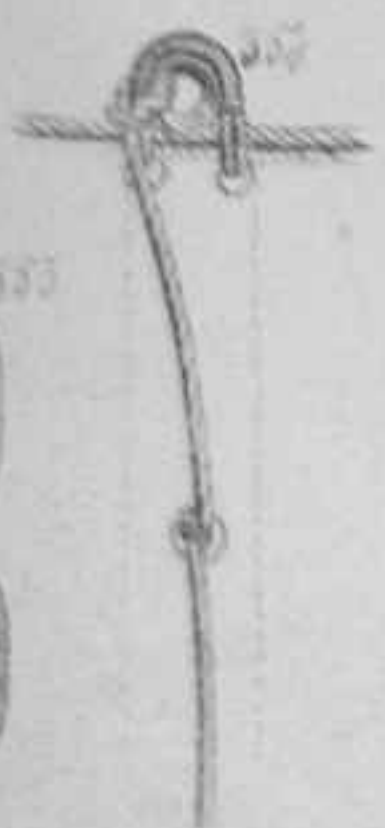
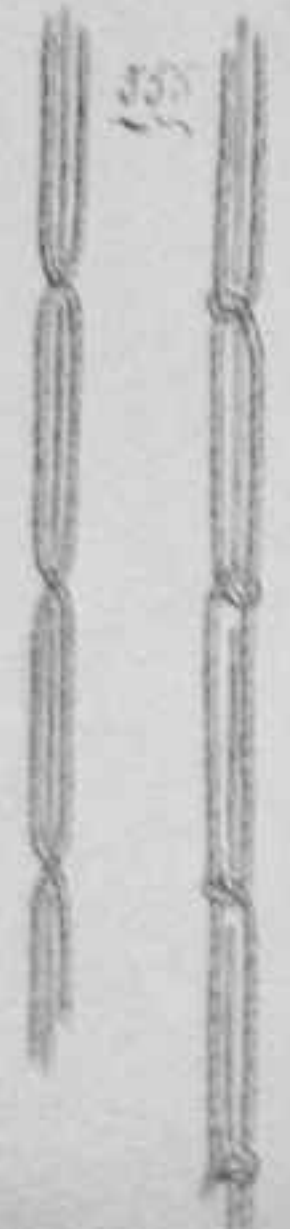
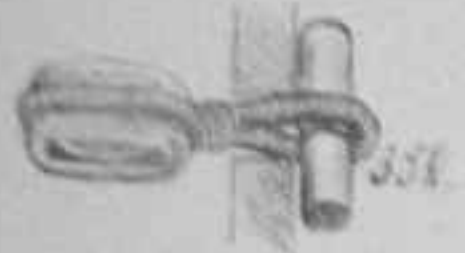
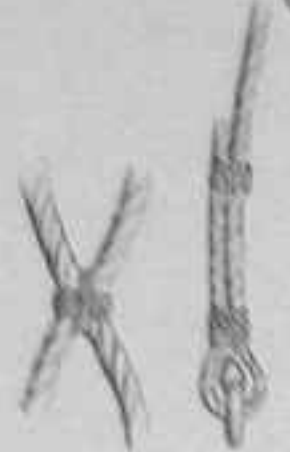
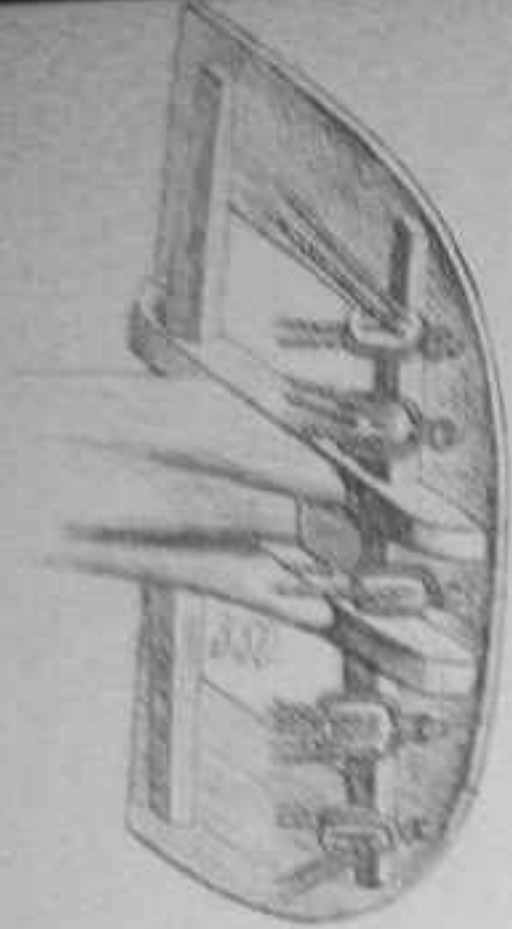

See page 43

Ames

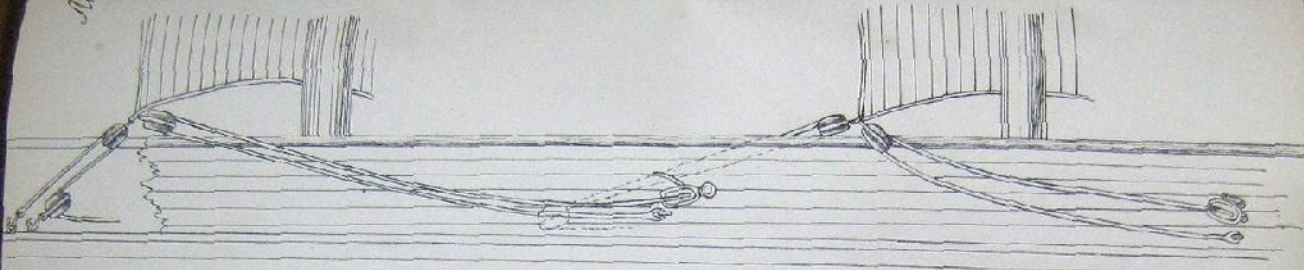

551

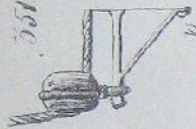

552

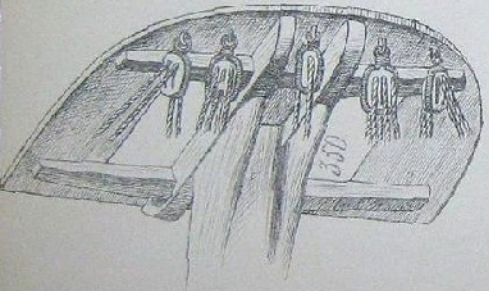

553



554

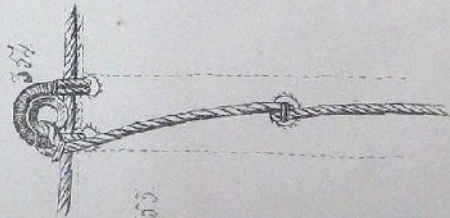

555



556

1000. 44

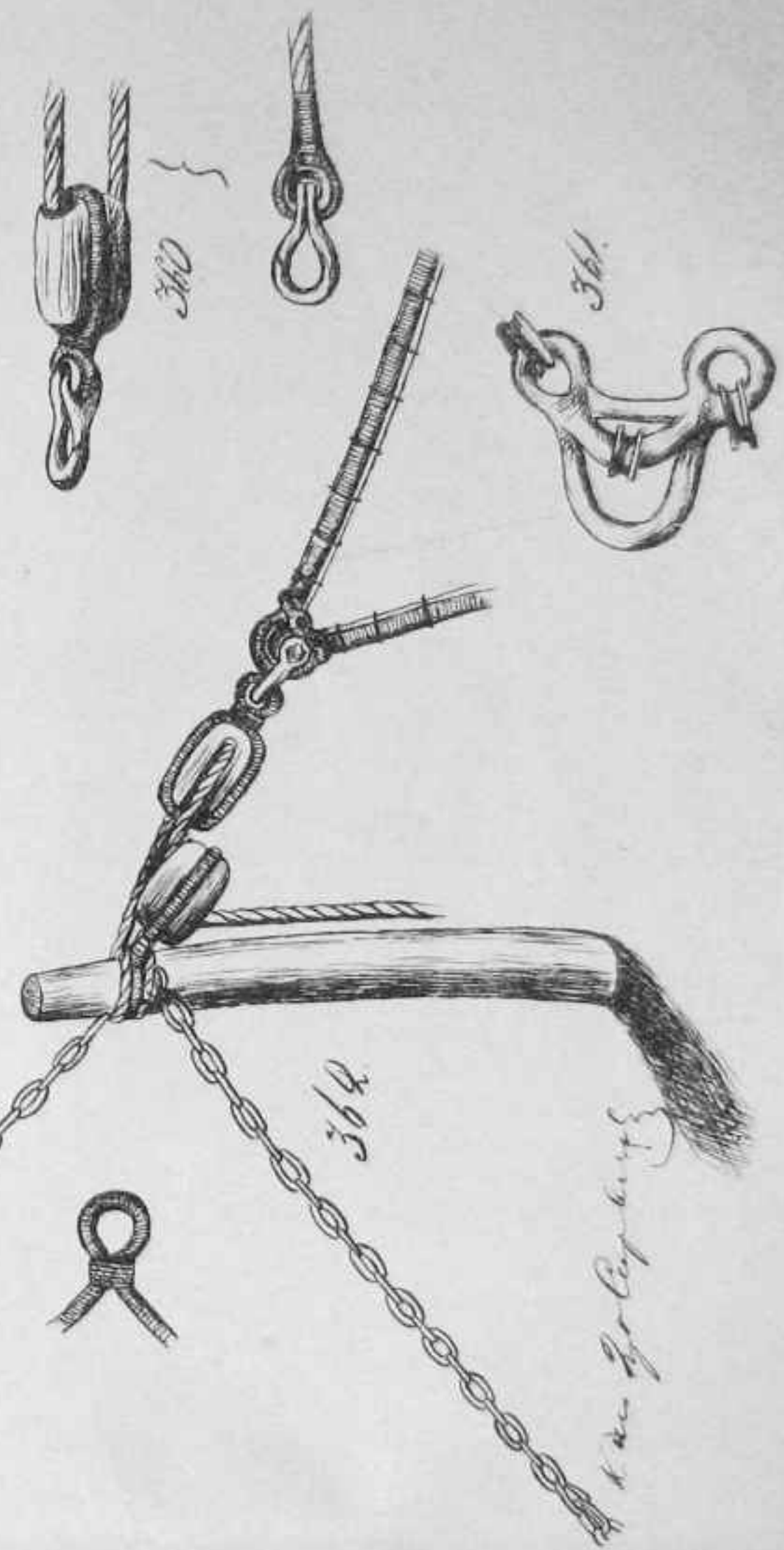
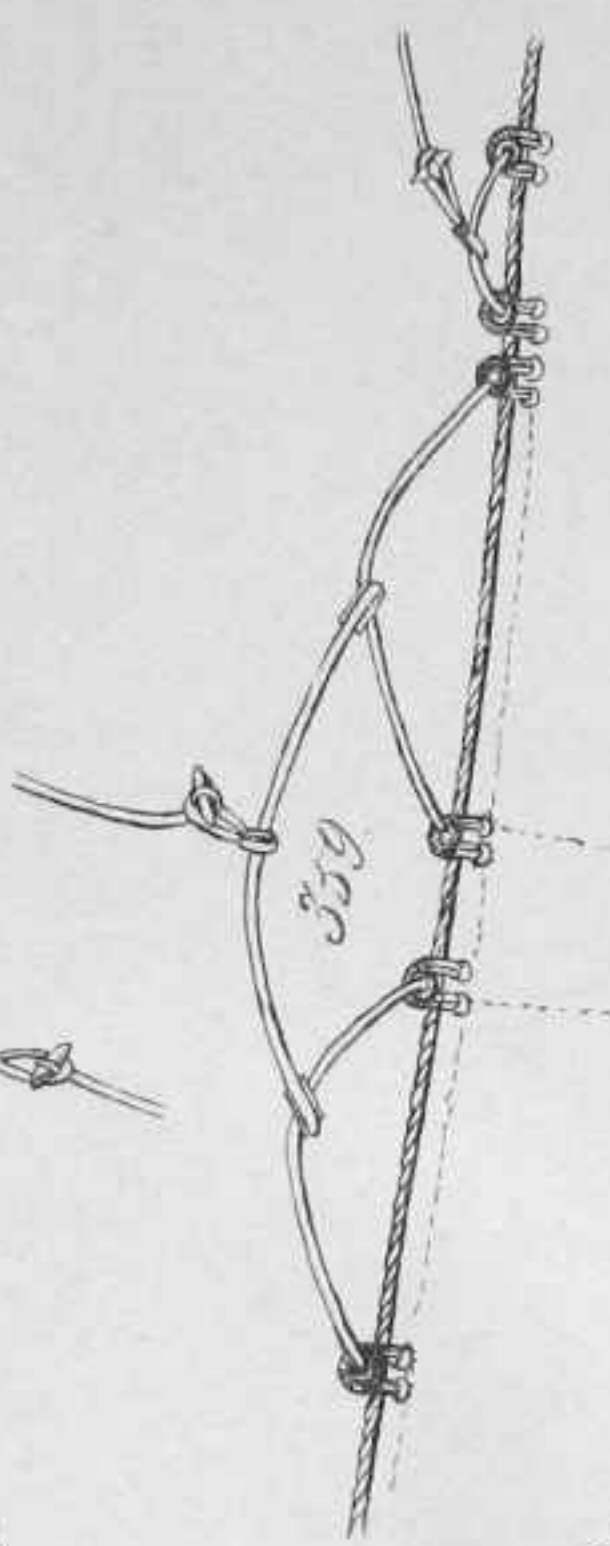
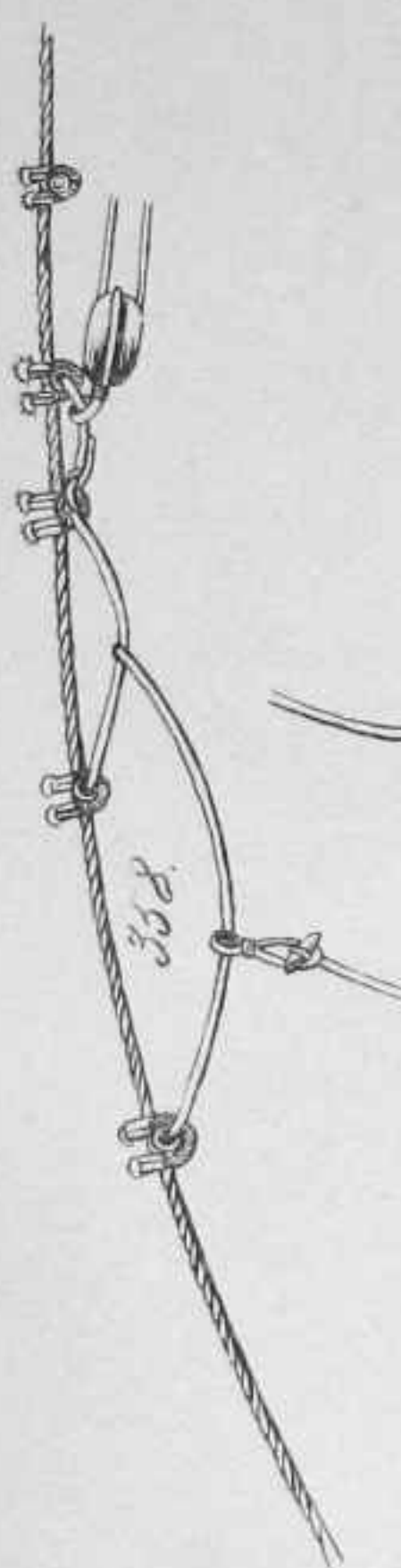
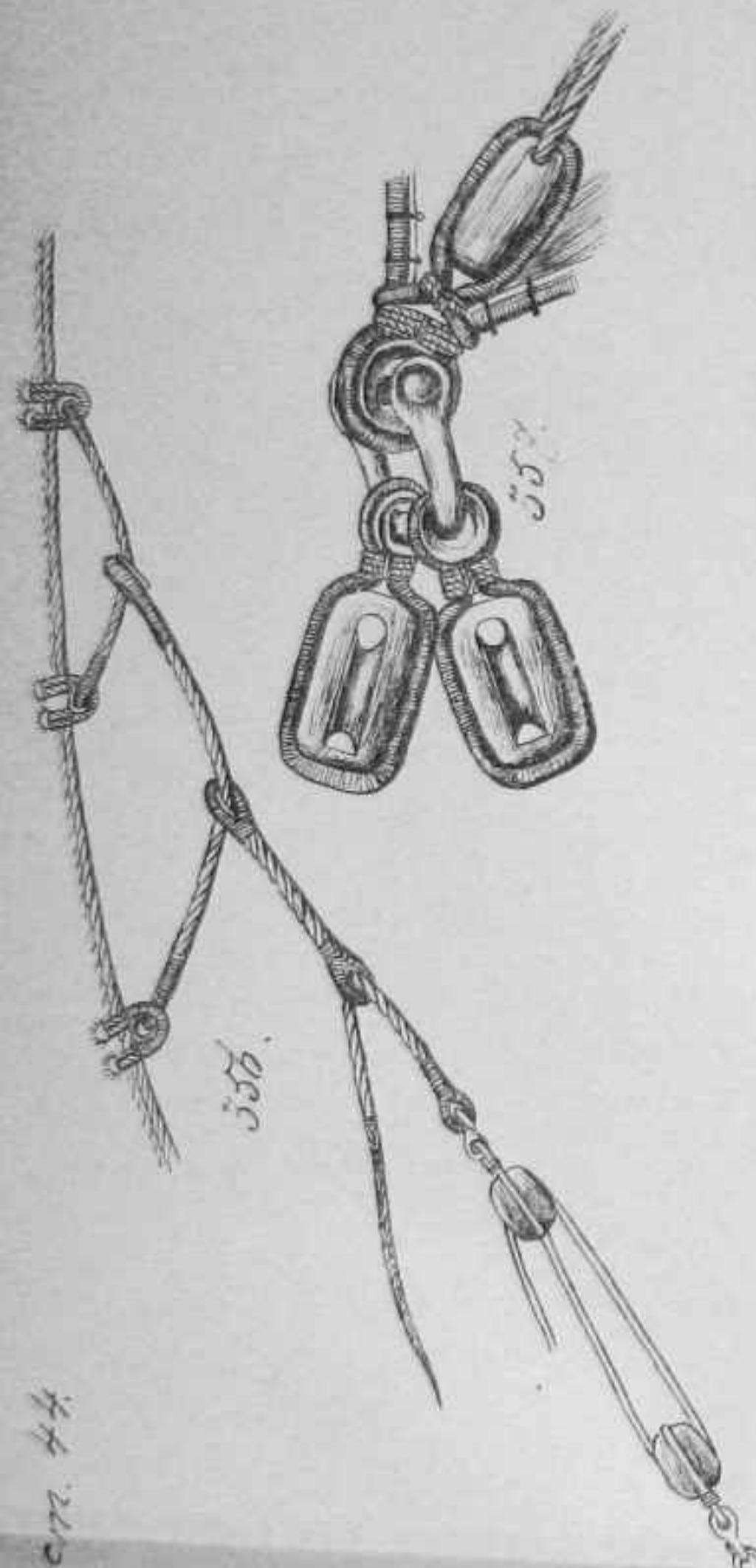

Platm. 45.

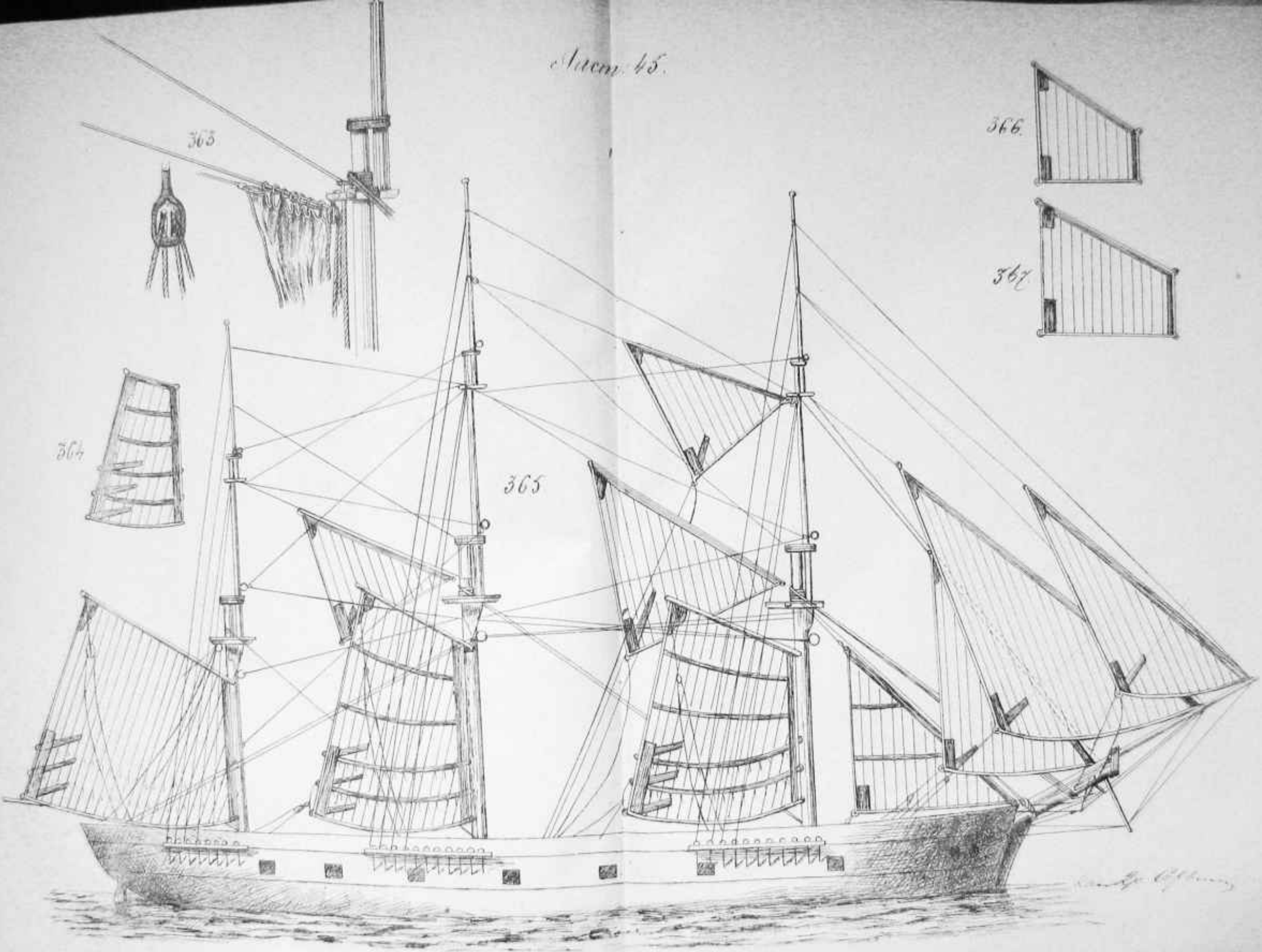

363

366

367

364

365

Wm. G. L. [unclear]

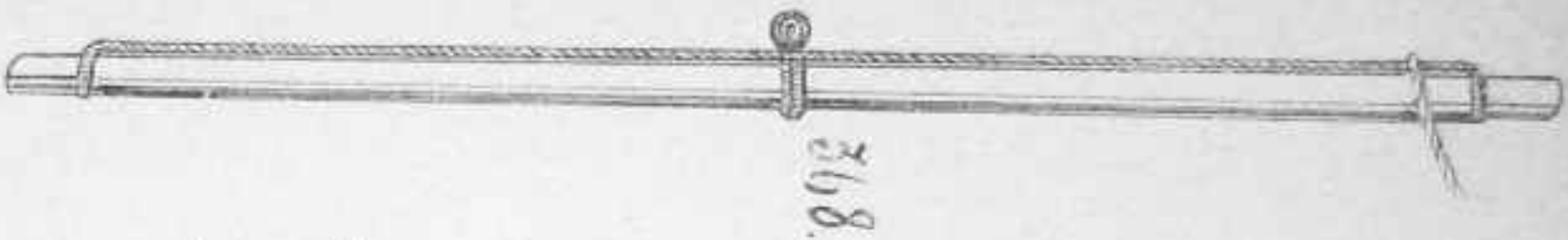

368.

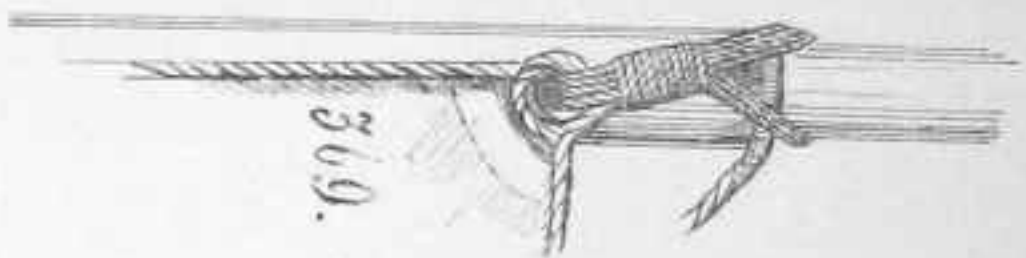

369.

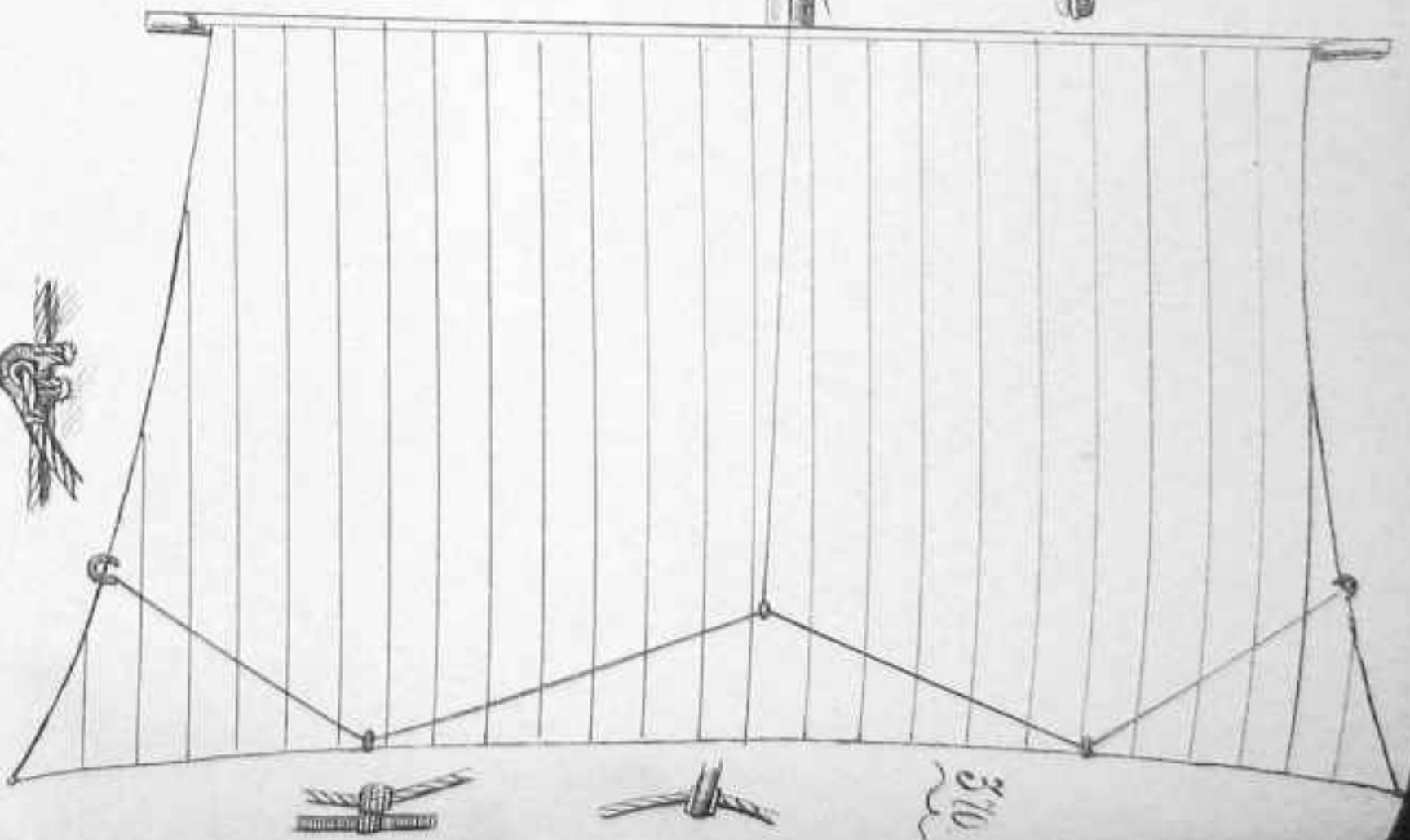
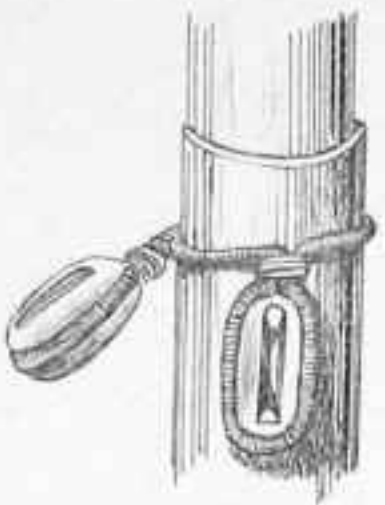
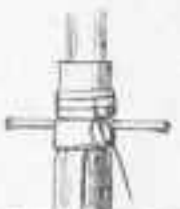

370.

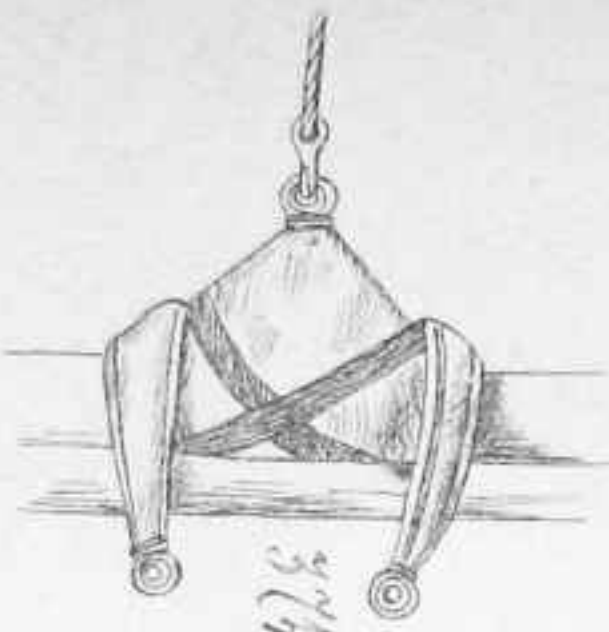

374.



375.

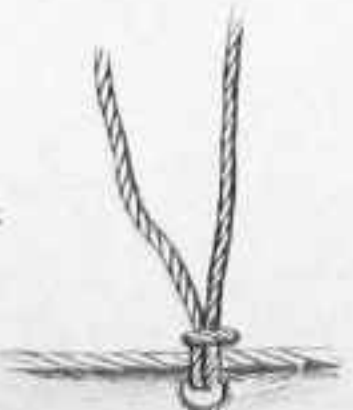

379.

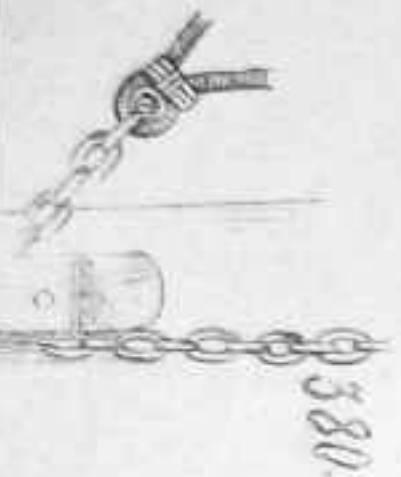

380.

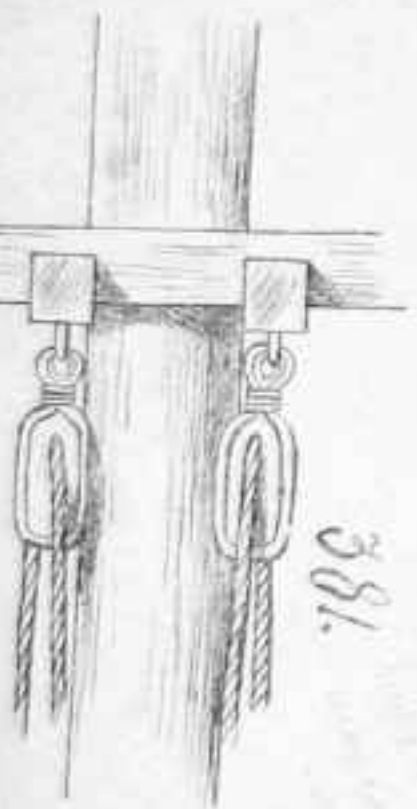

381.

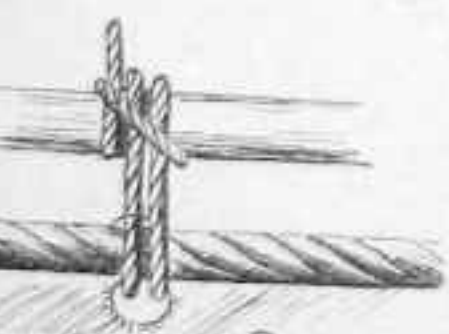

382.

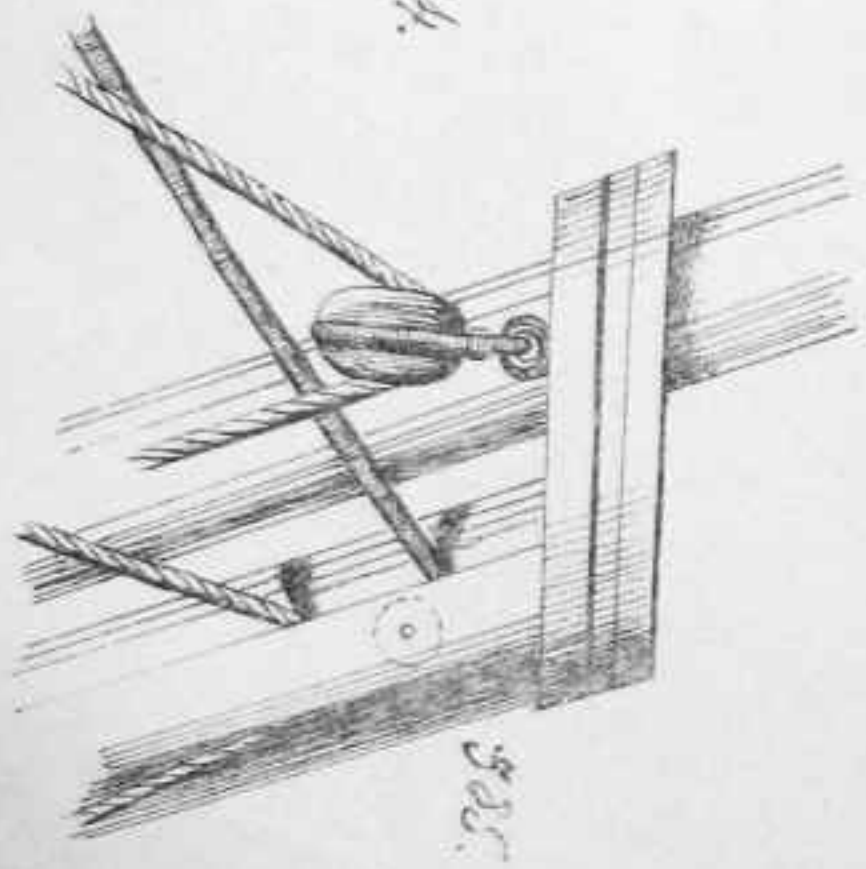
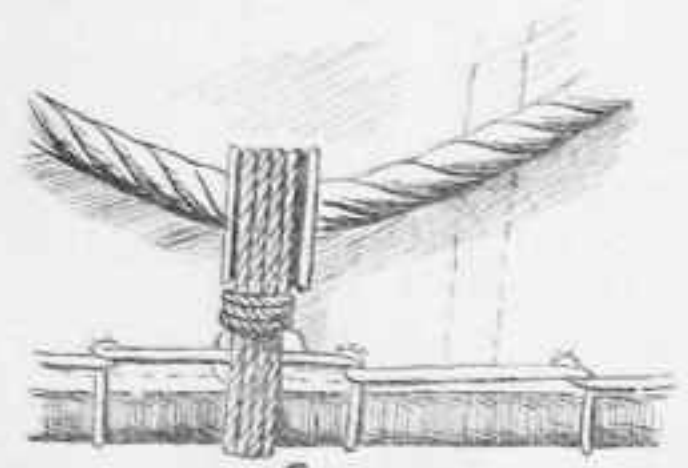
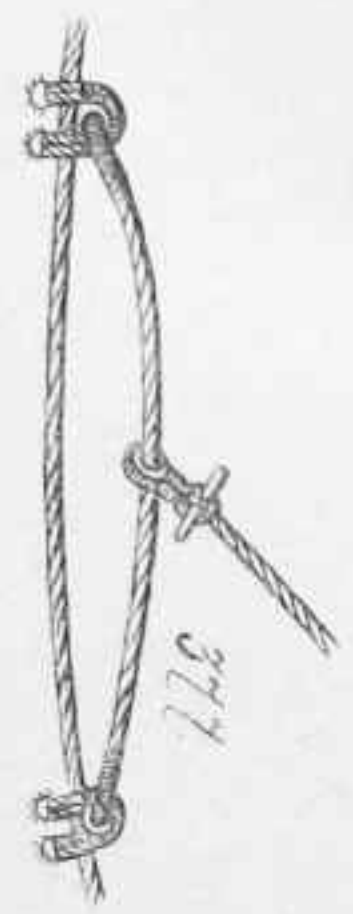
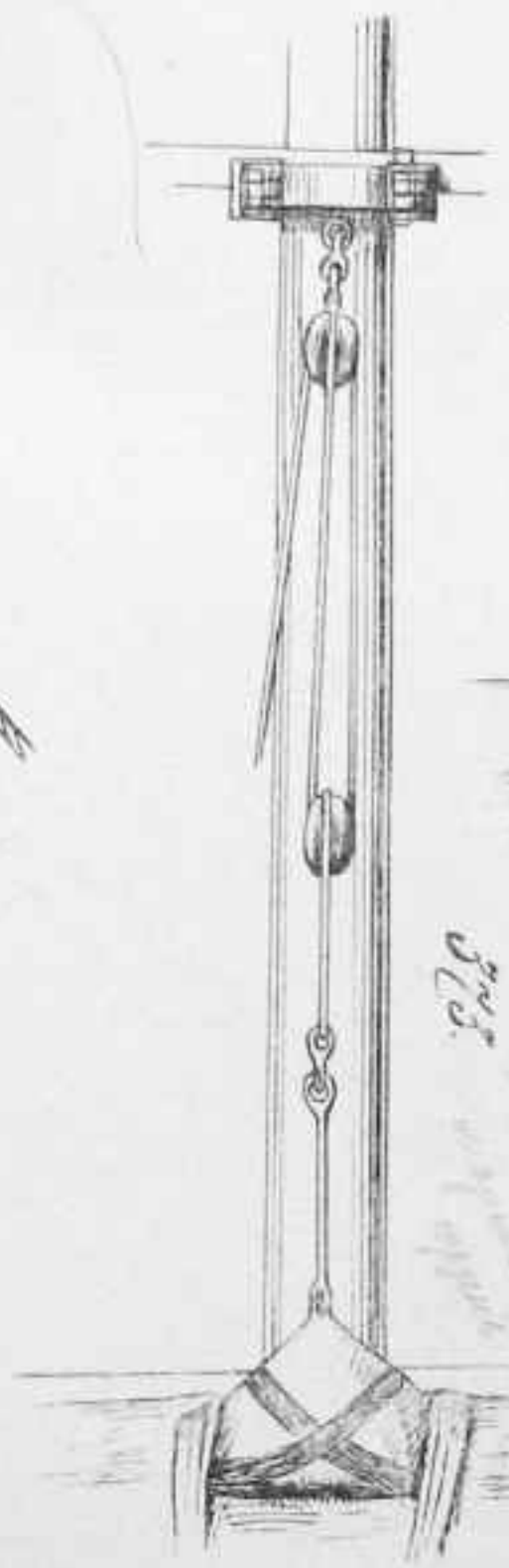
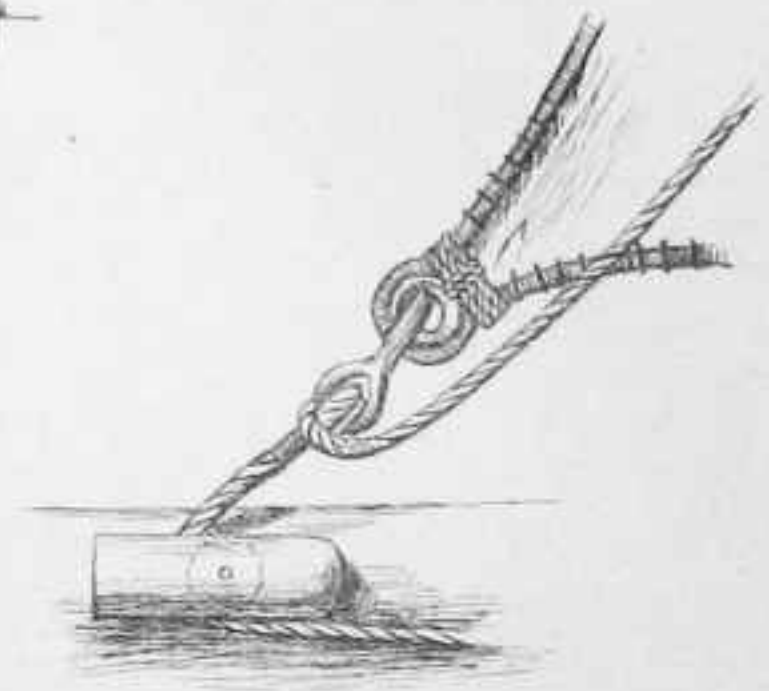
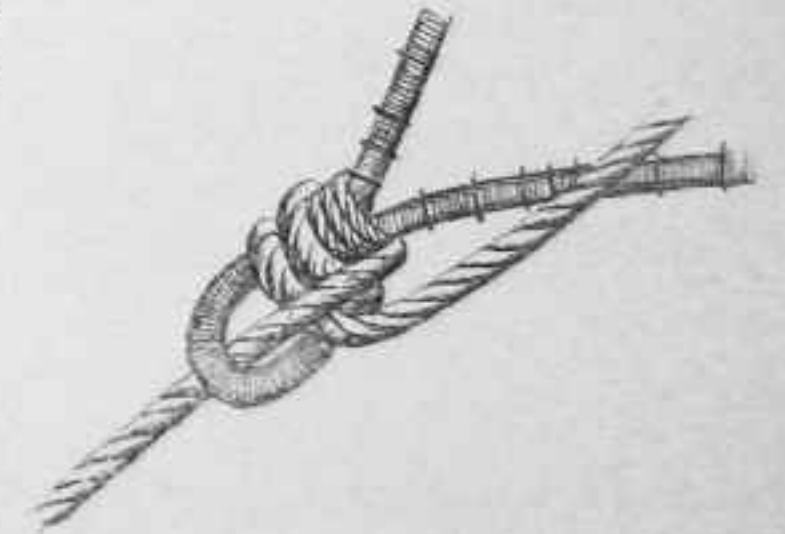
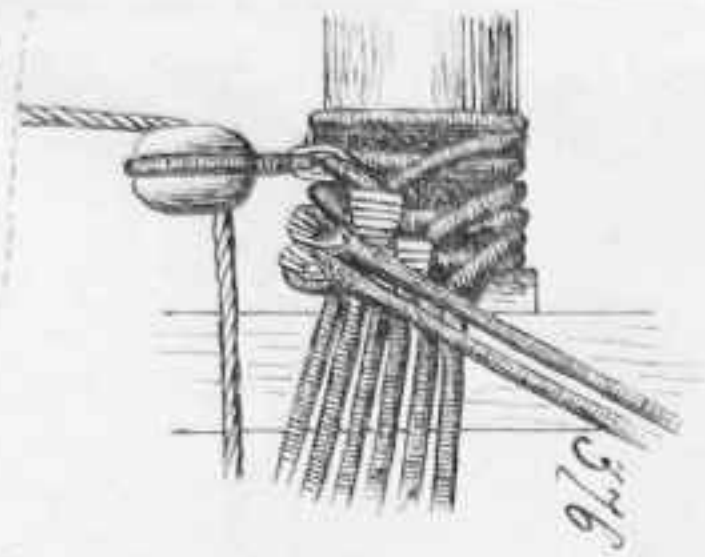
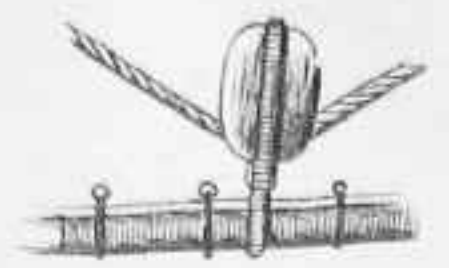
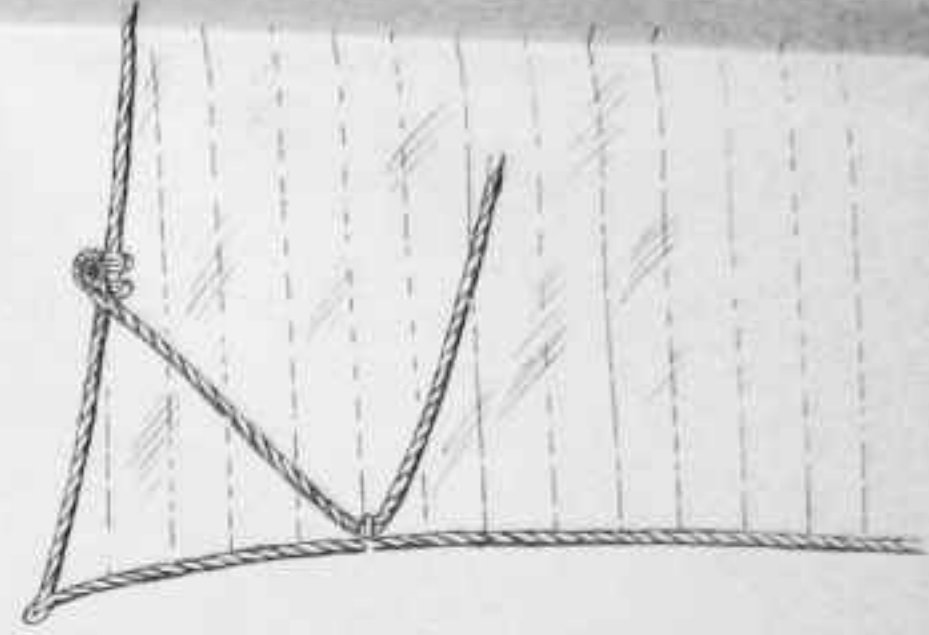

371.

372.

373.

376.

377.

378.

383.

384.

385.

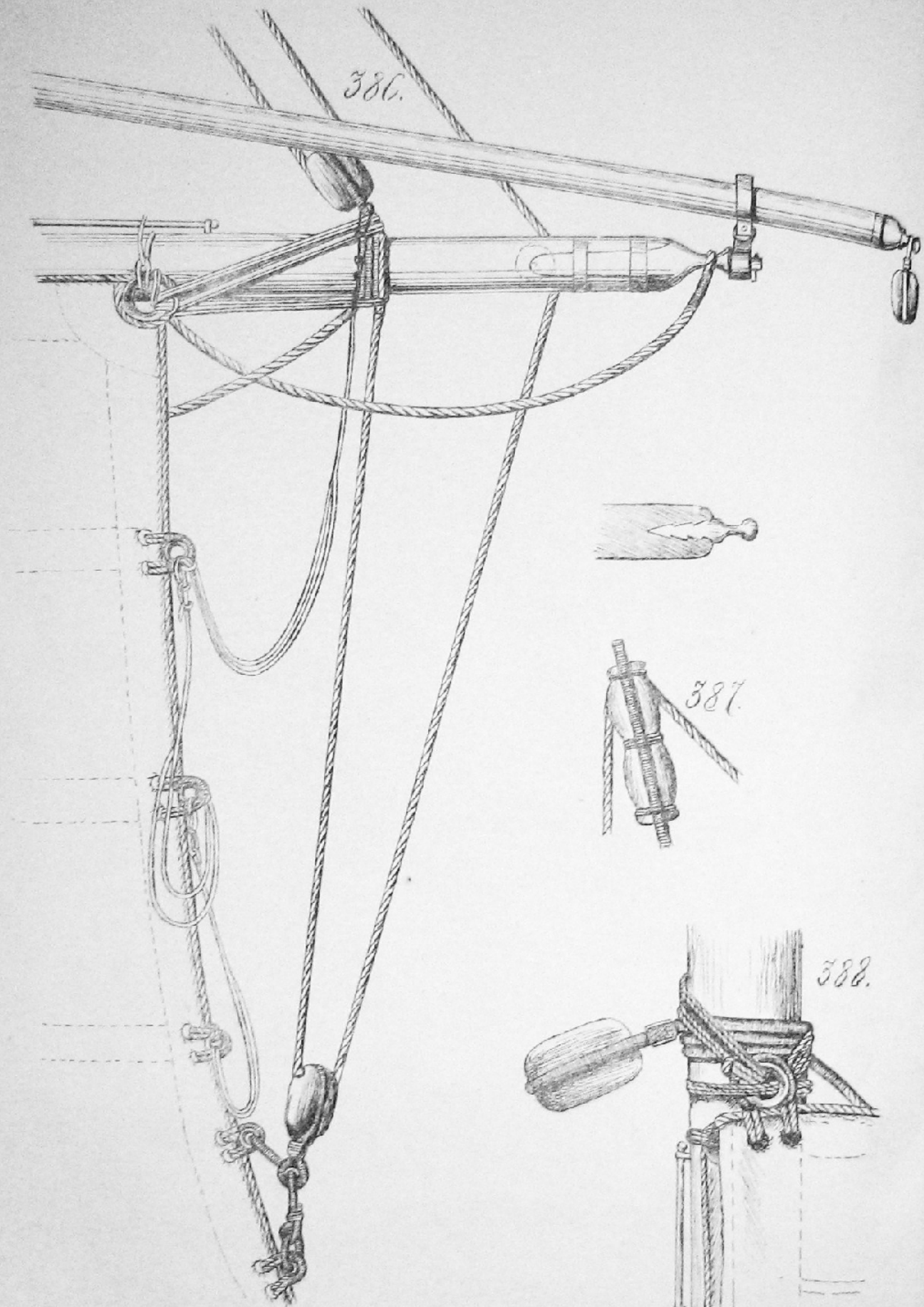

From Dr.

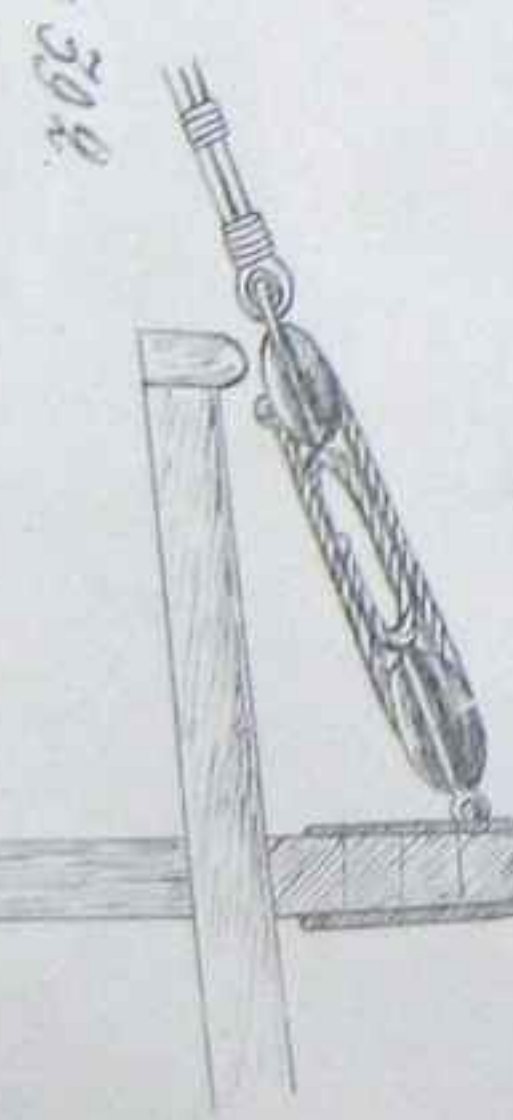
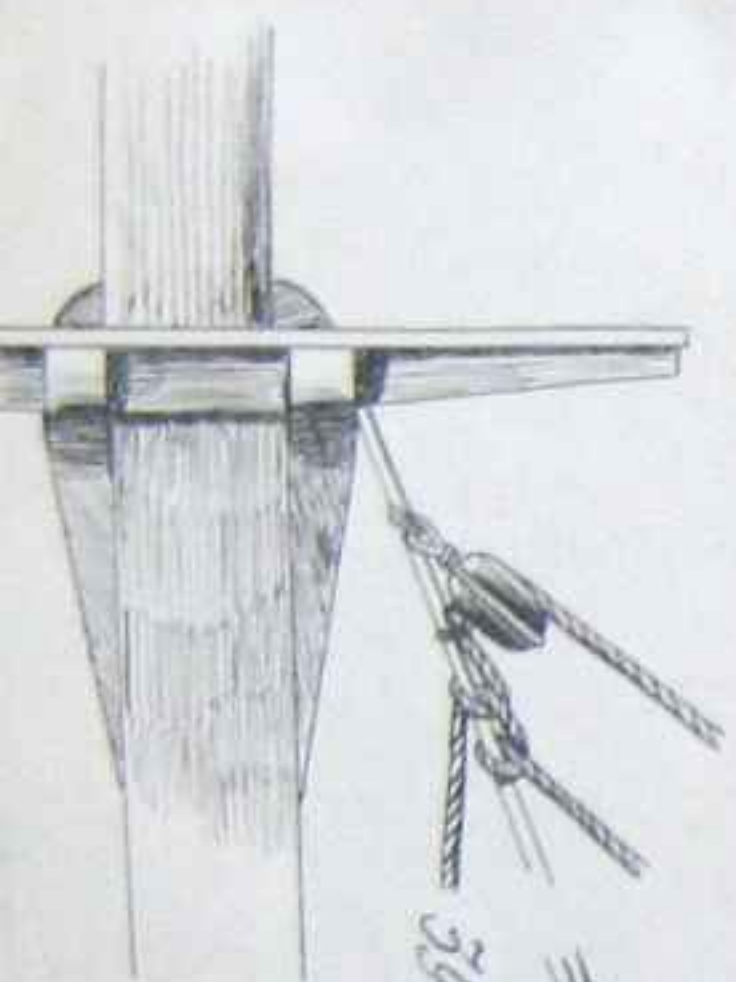
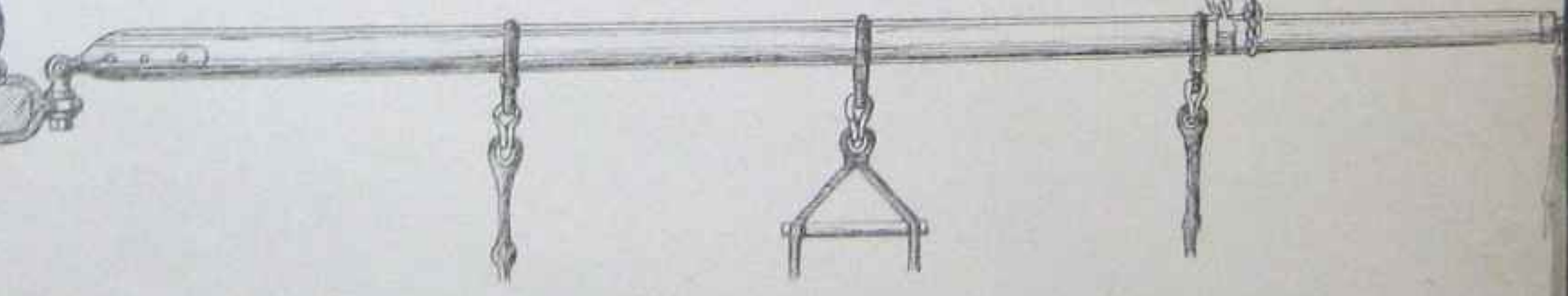
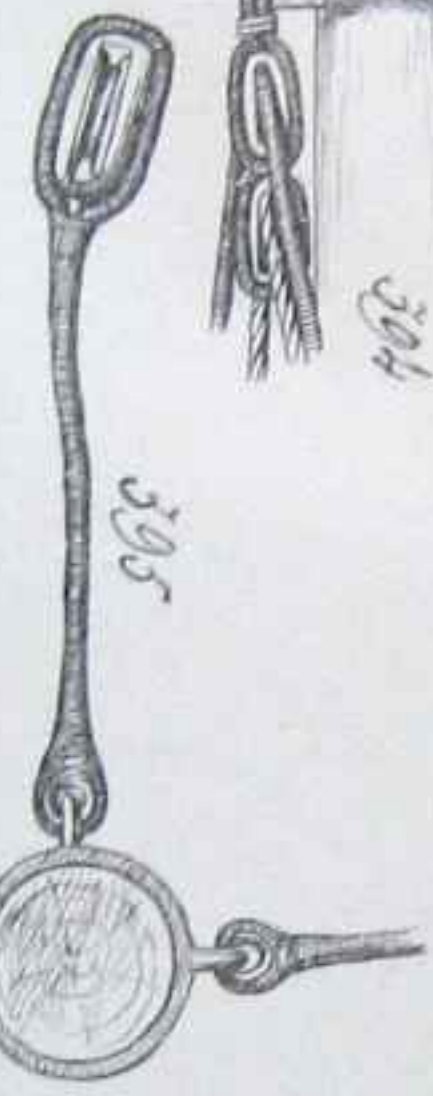
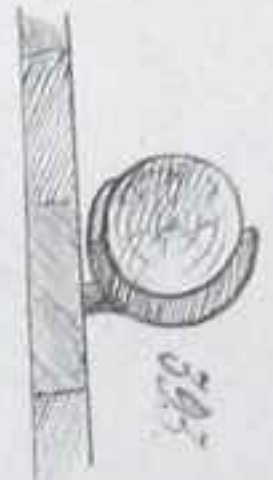
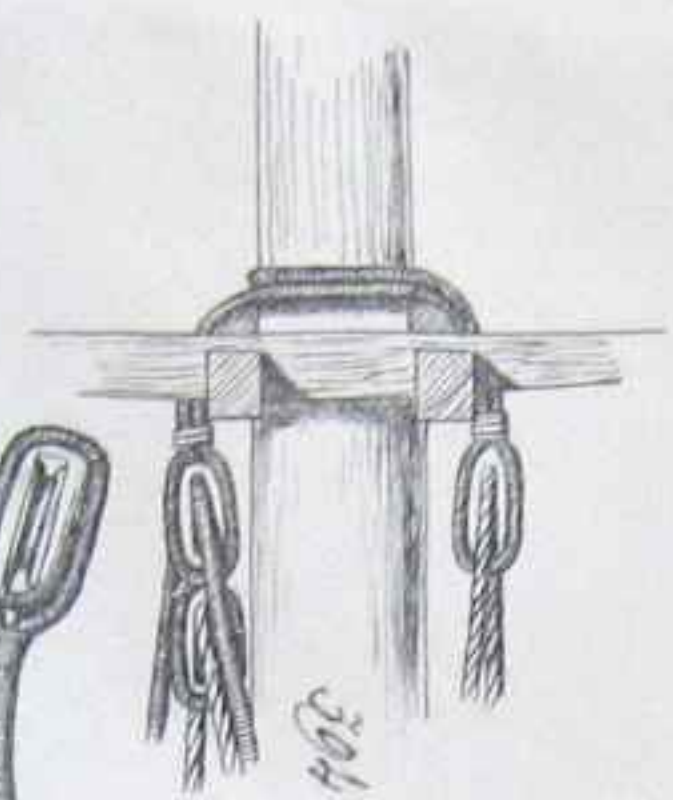
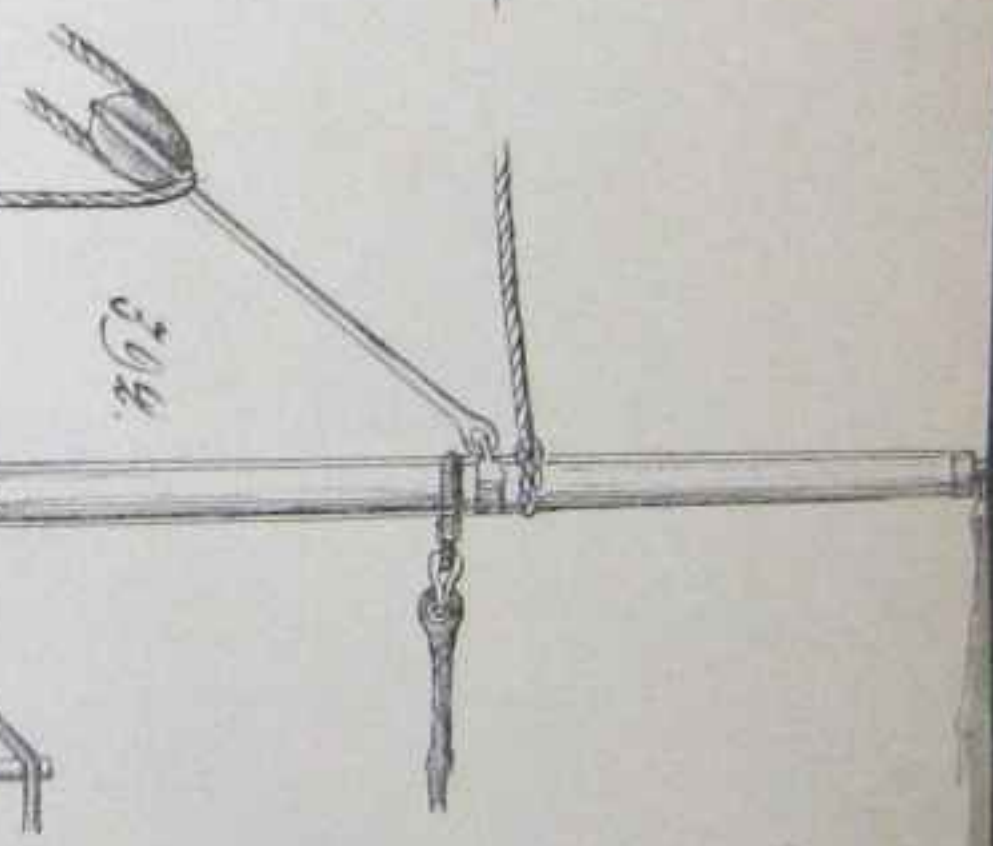
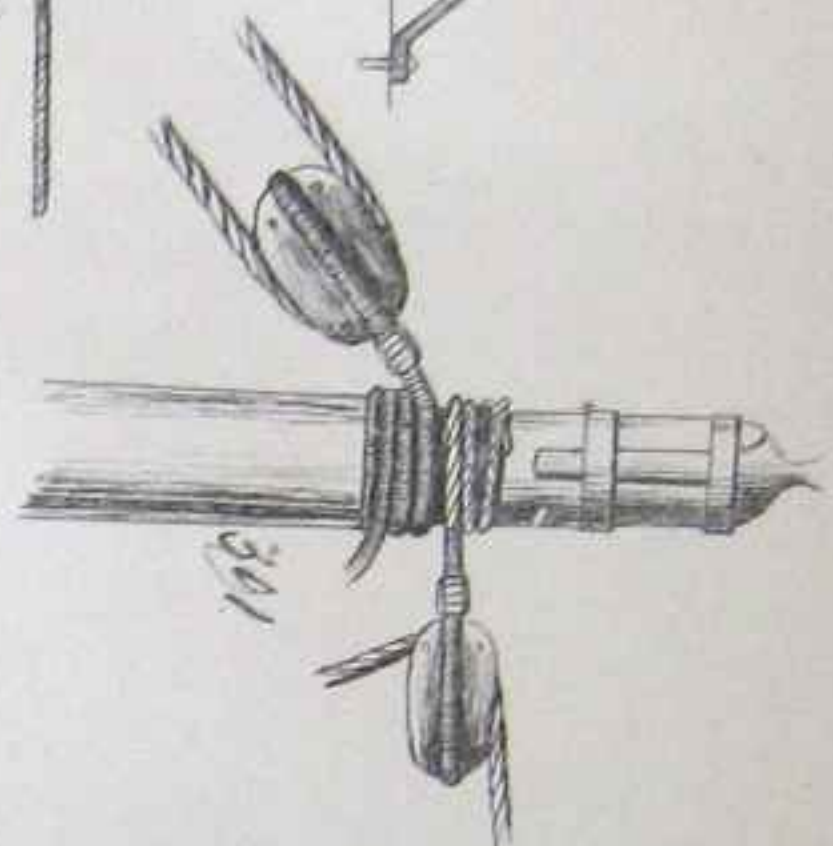
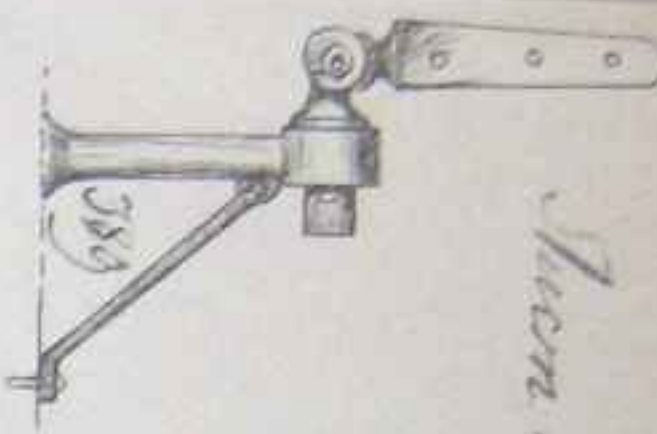

Can. of Systems

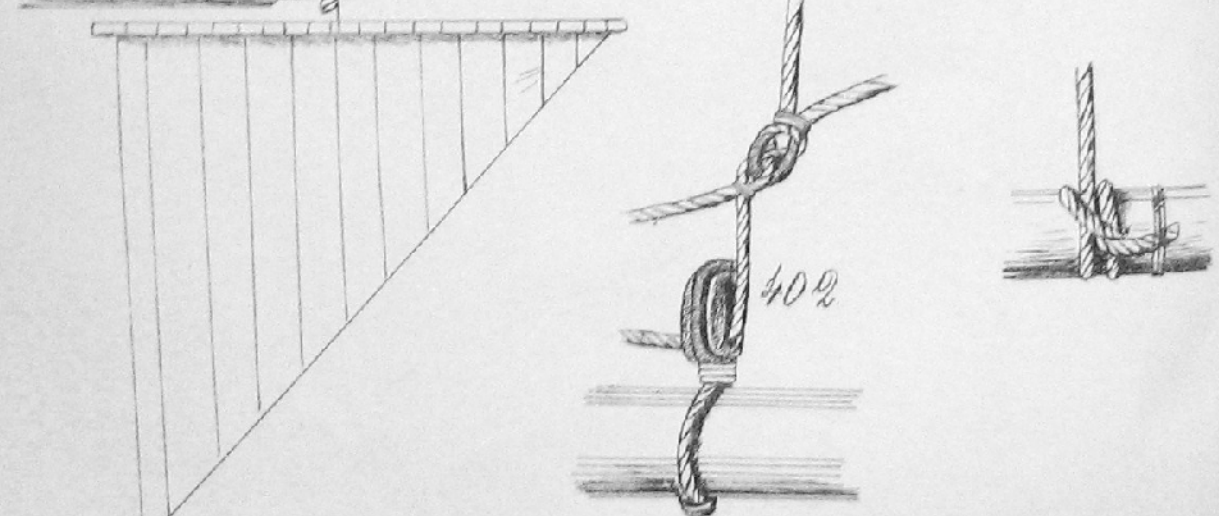
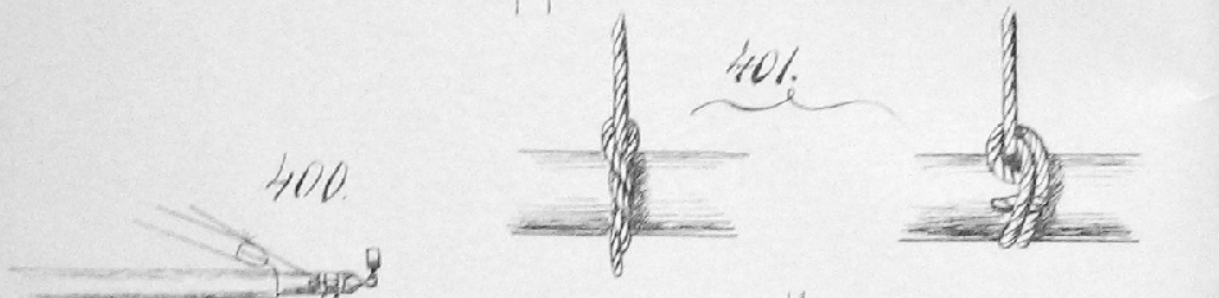
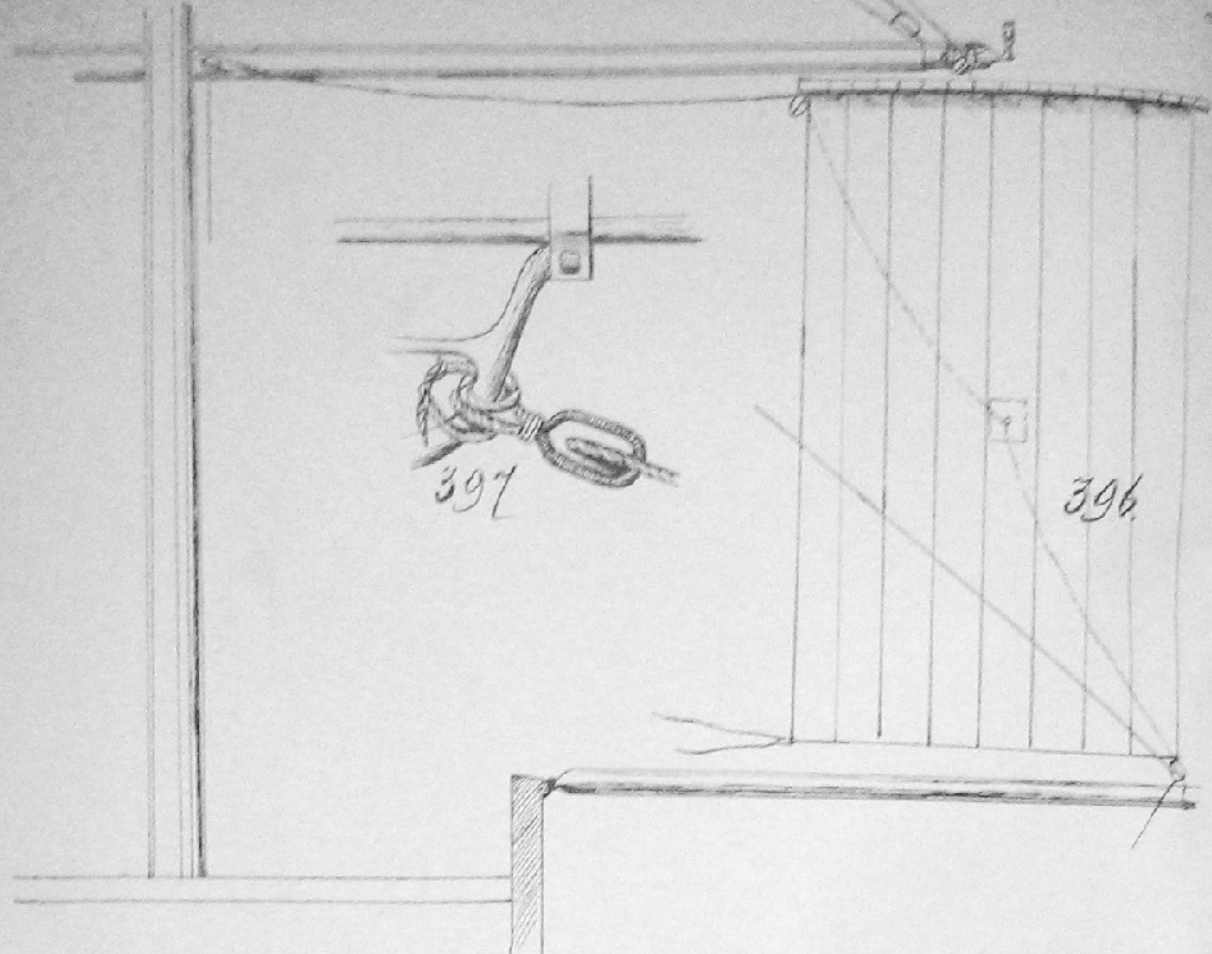

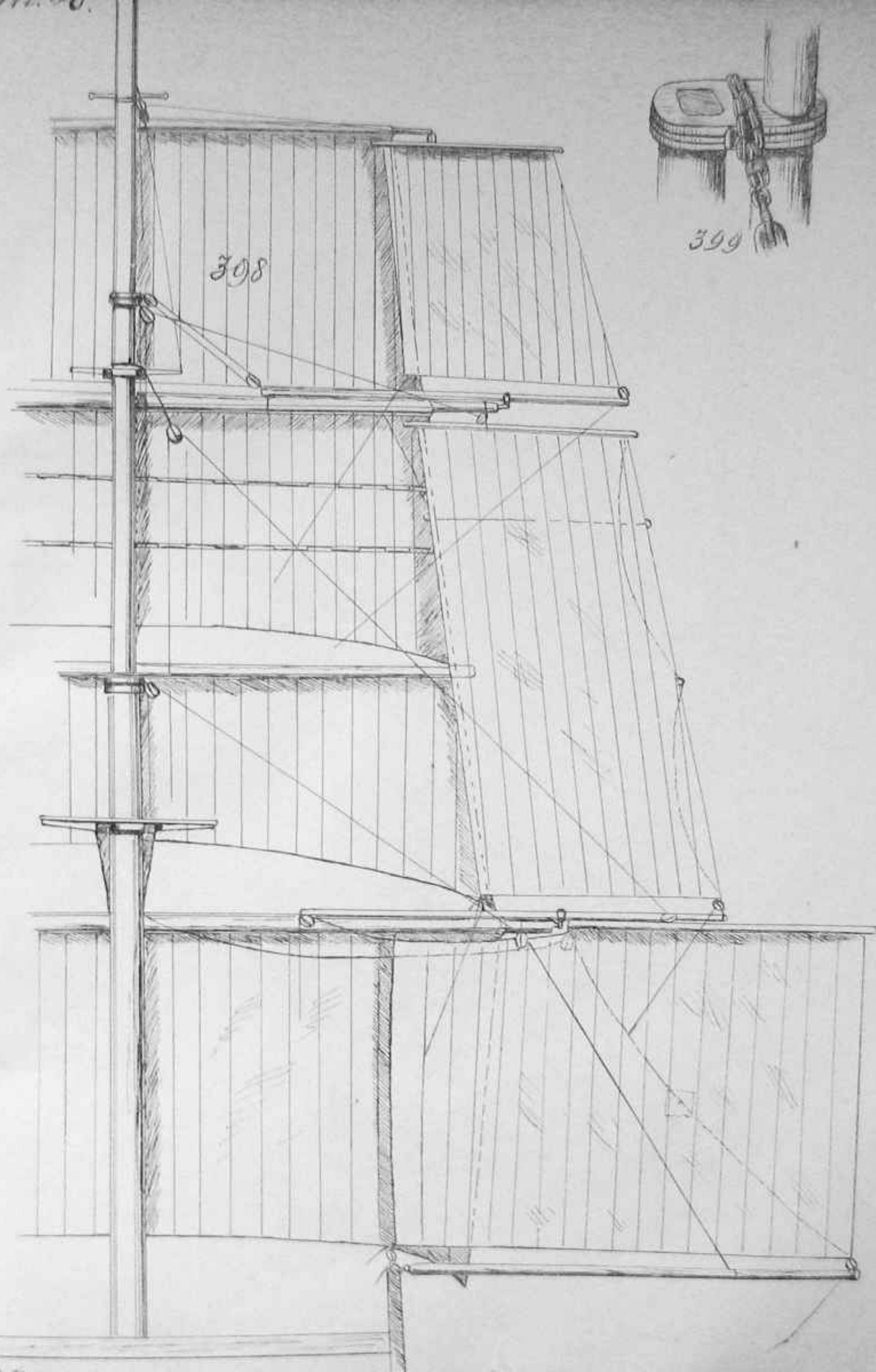

308

399

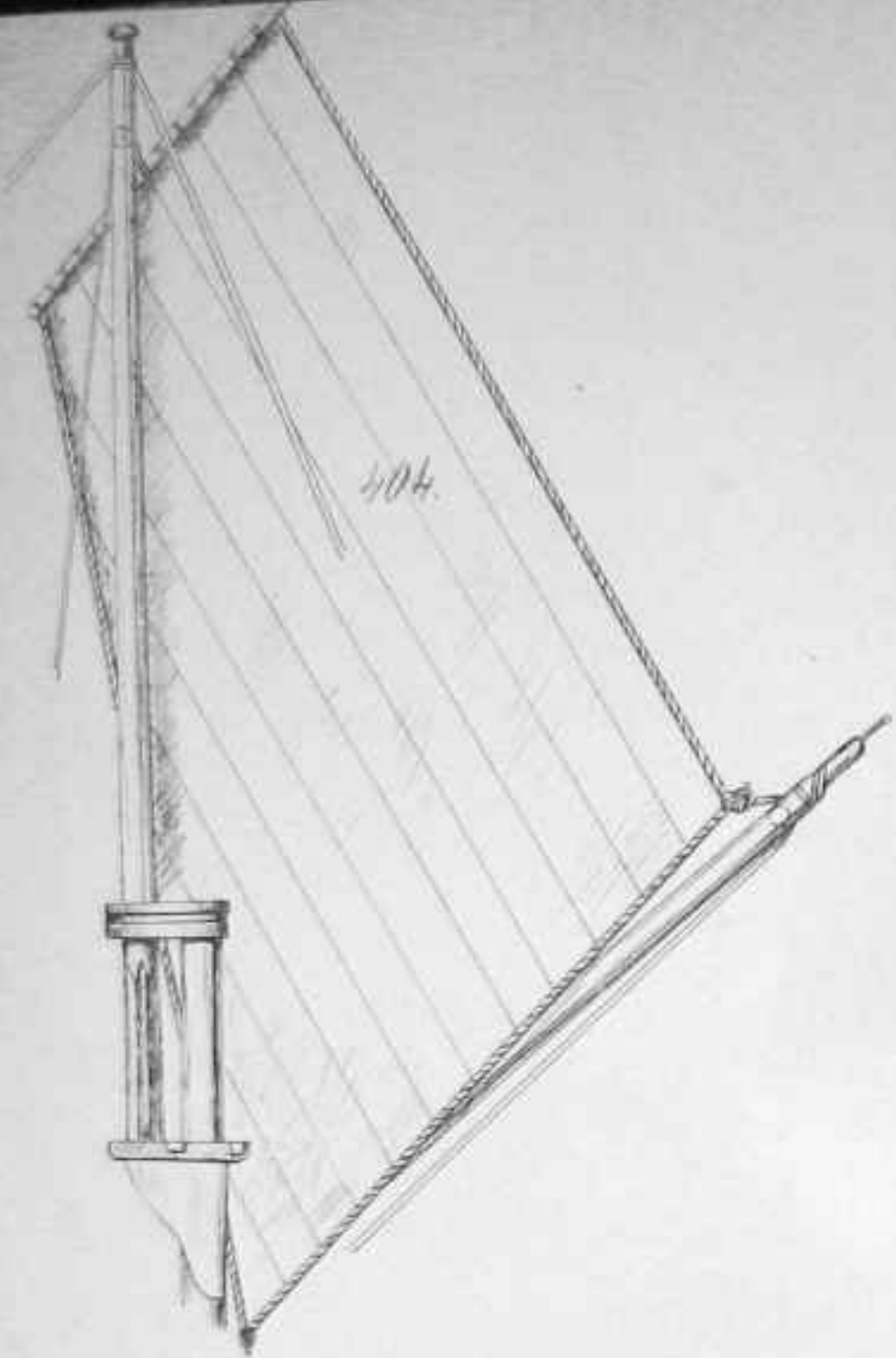

404.

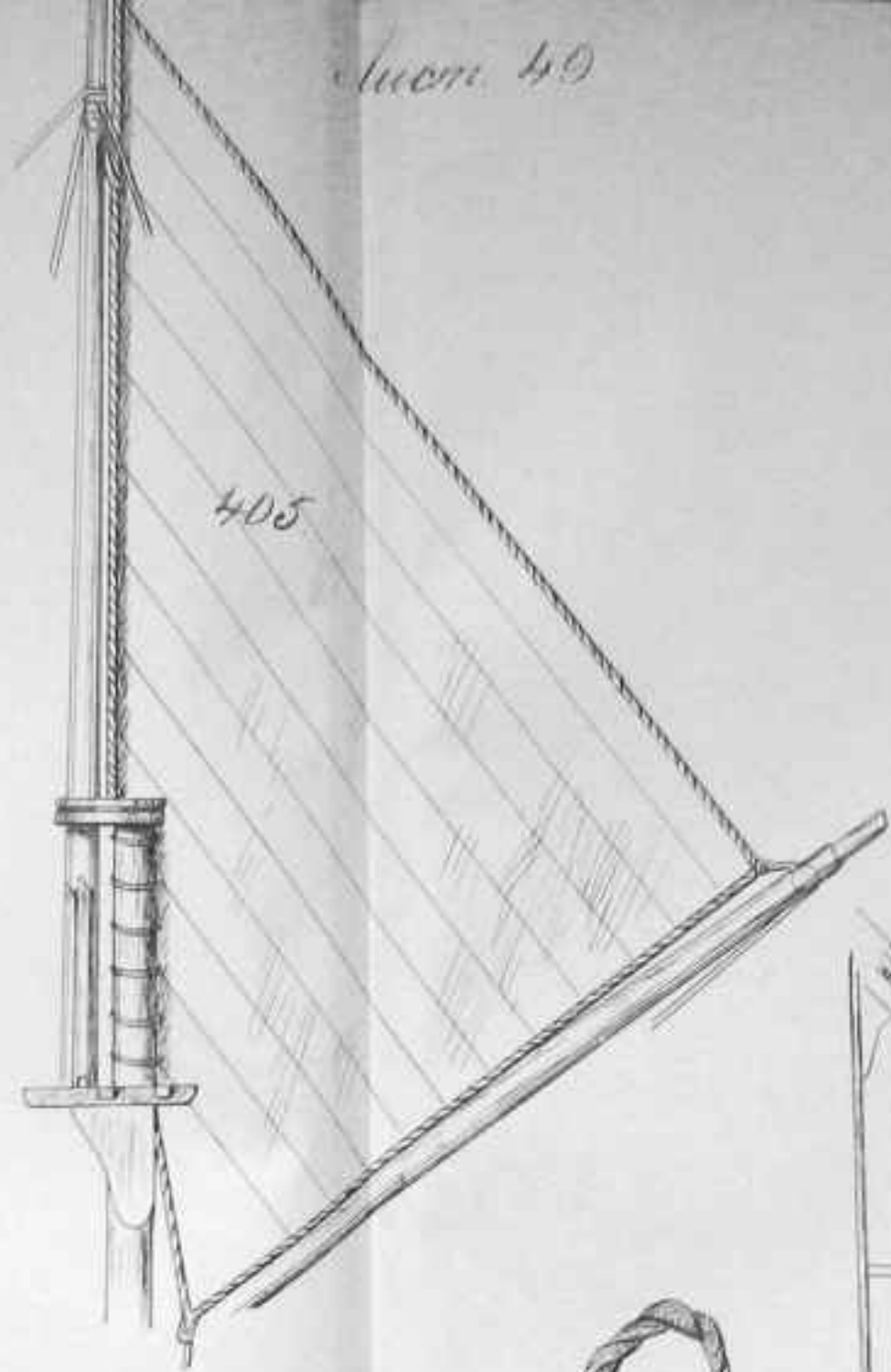

405

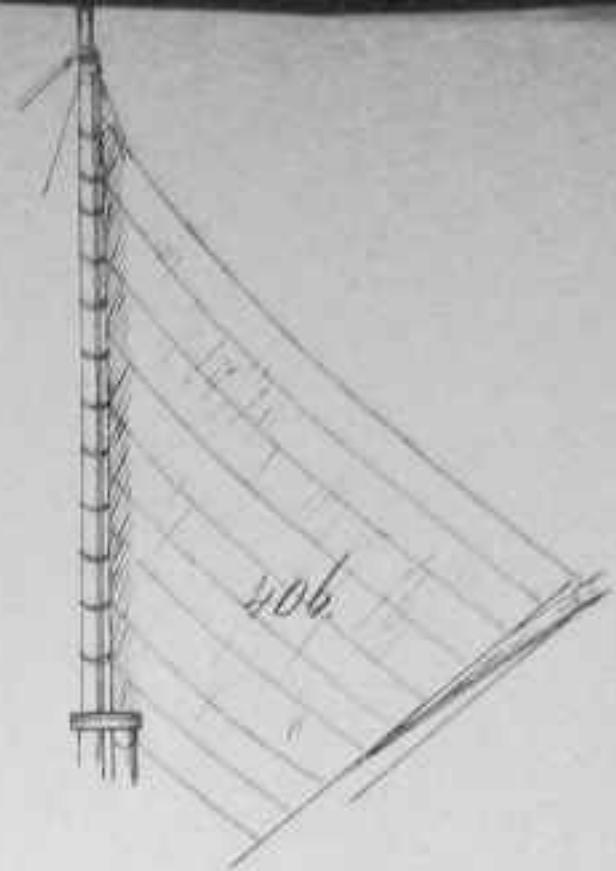

406

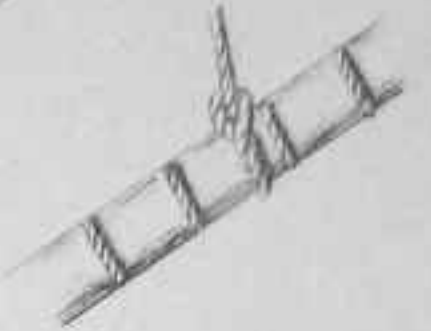

407

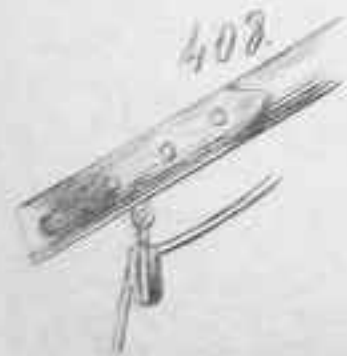

408



409

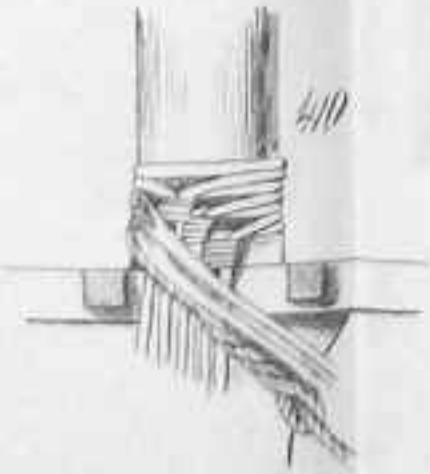

410



411

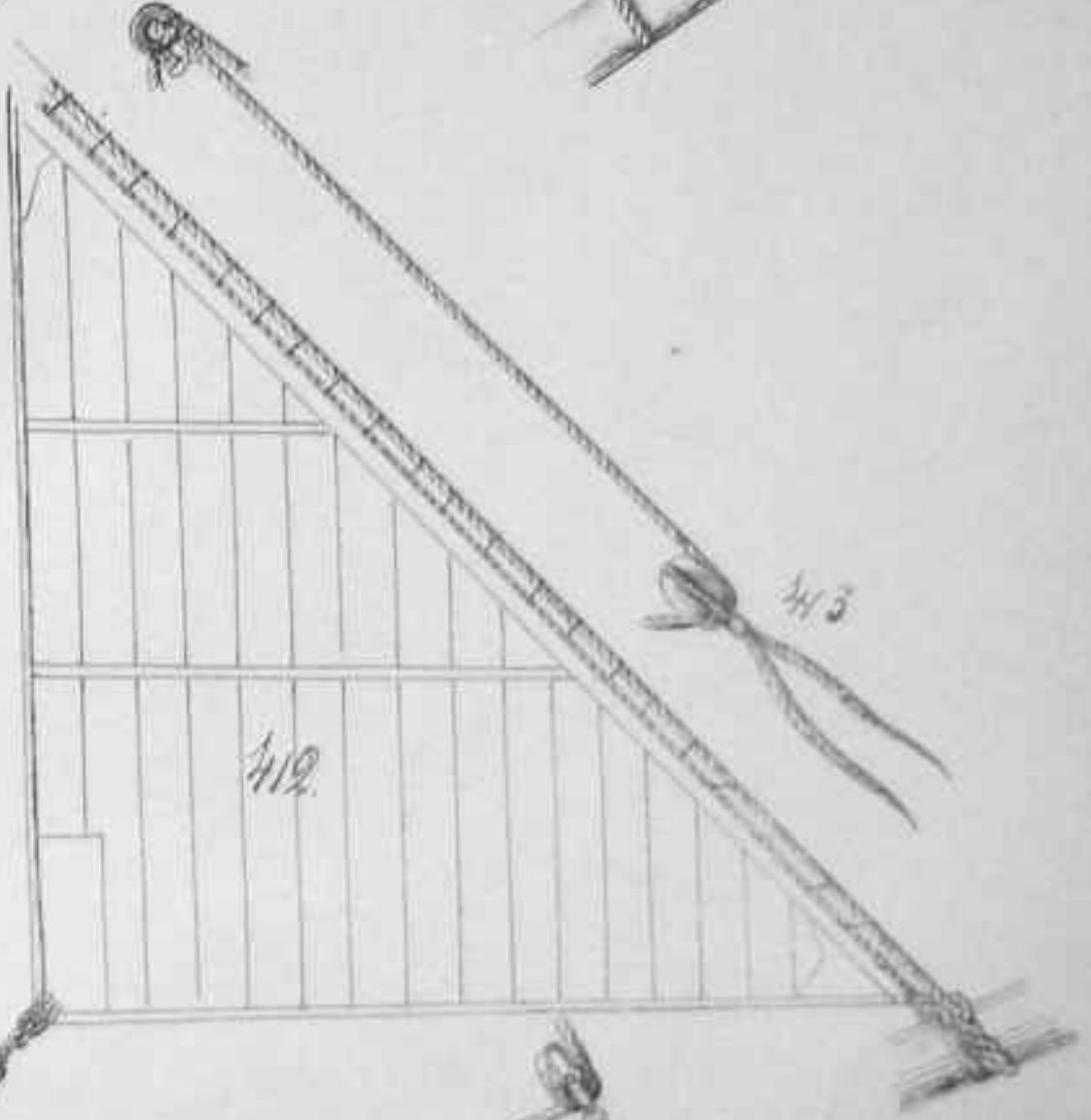

412



413

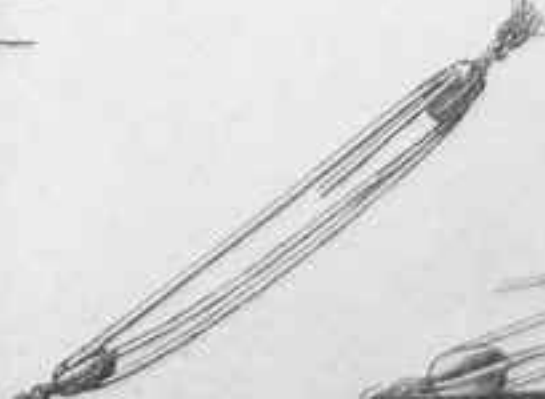

414



Drawn by Capt. ...

Lucia 50.

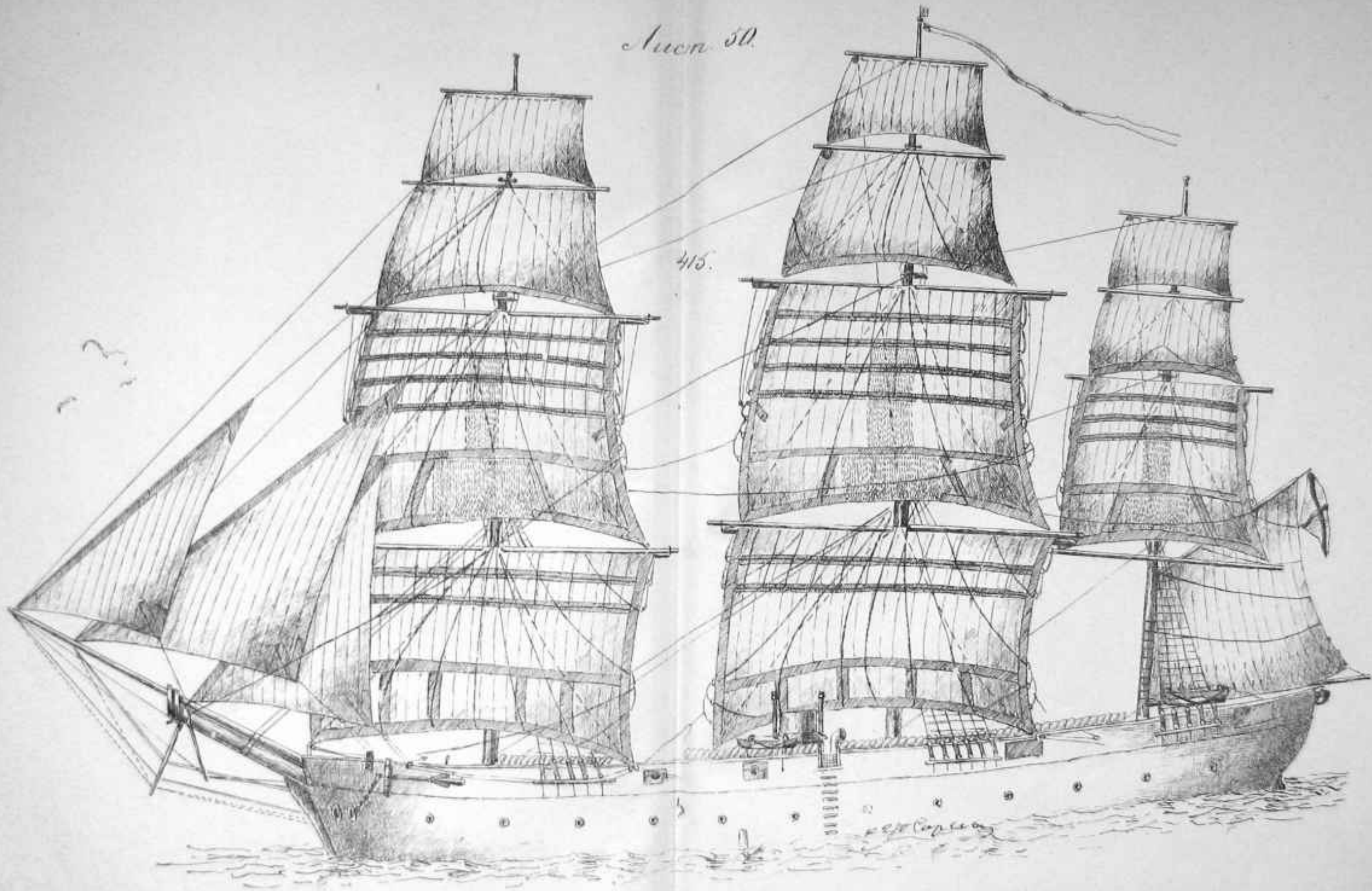

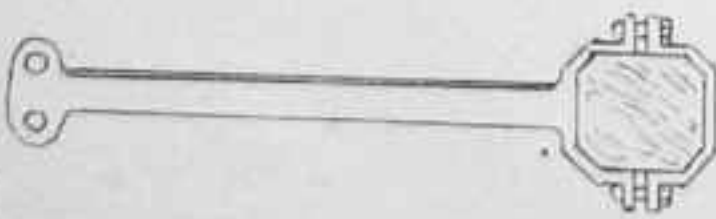
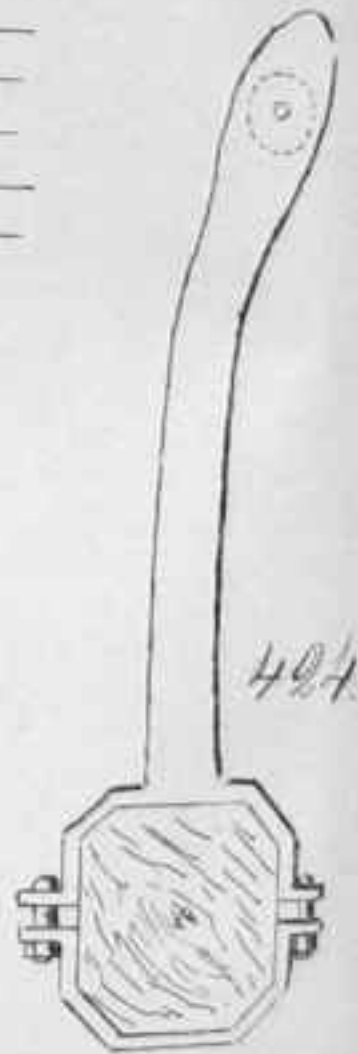
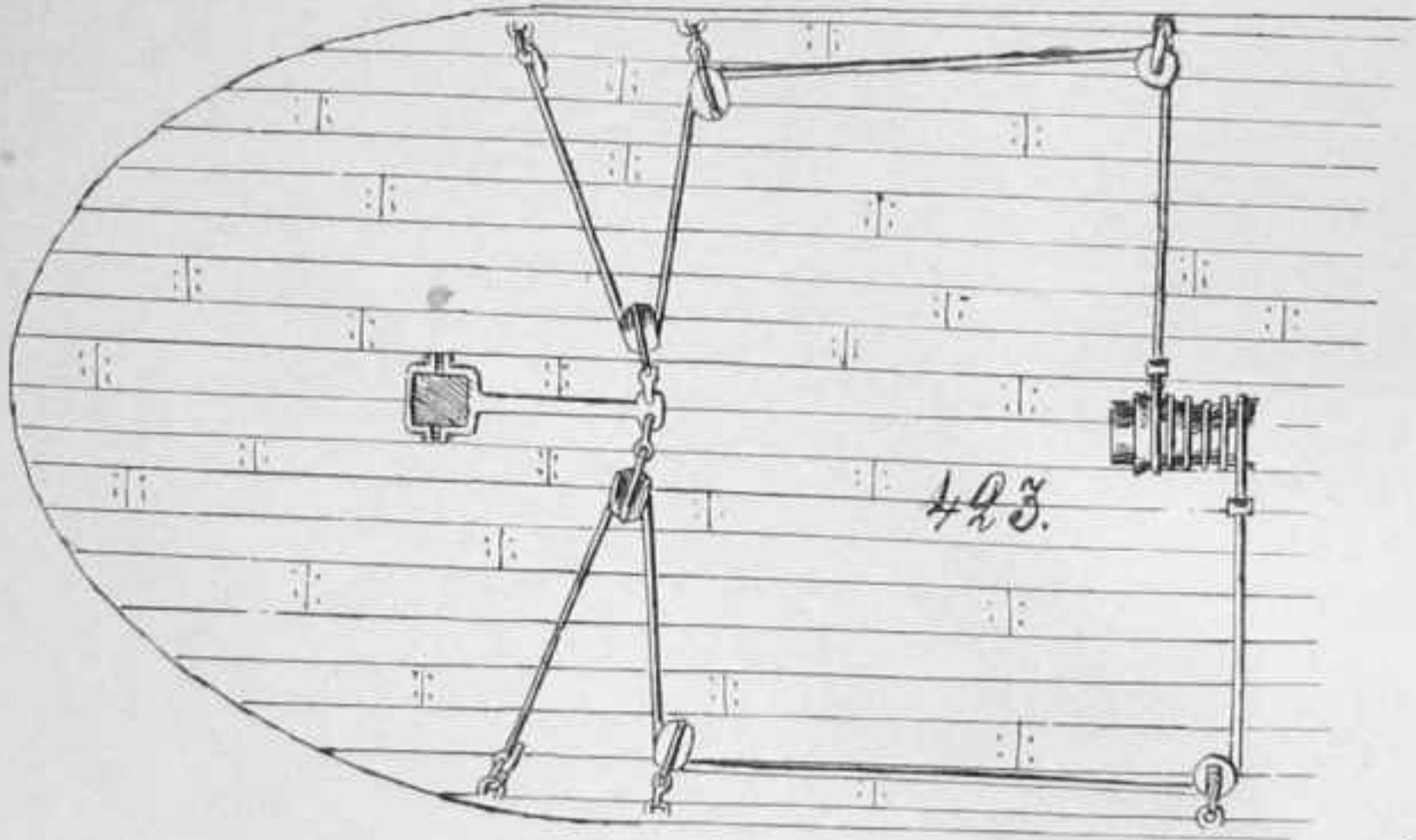
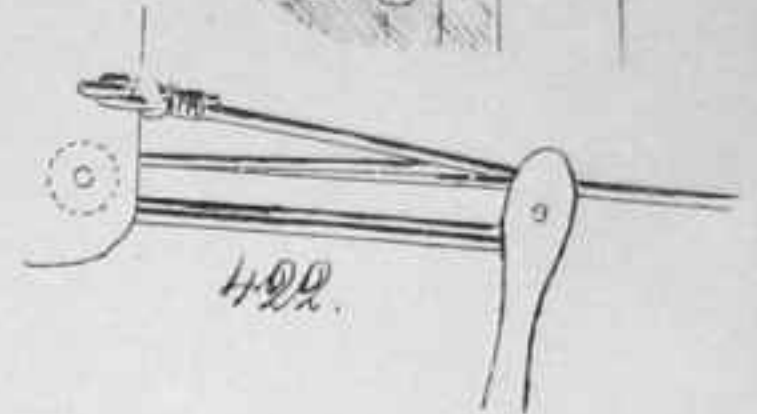
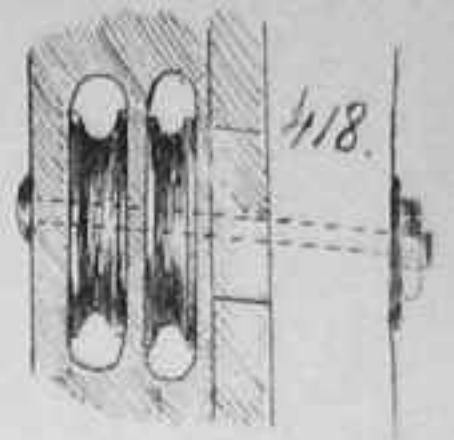
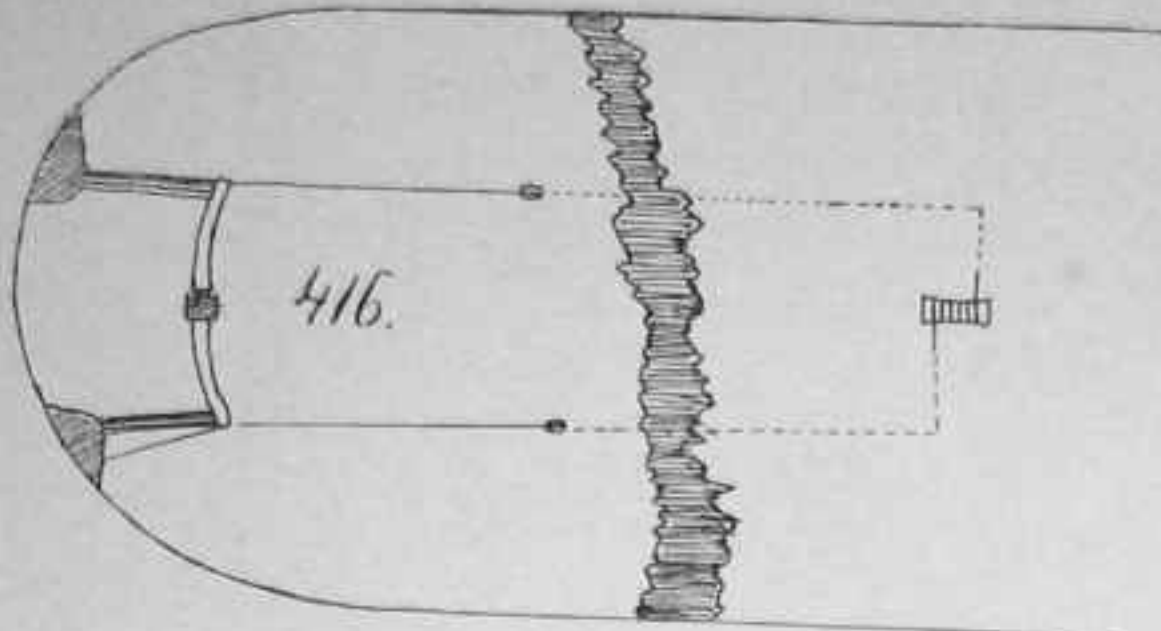
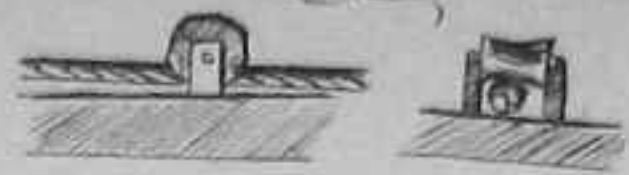

426.

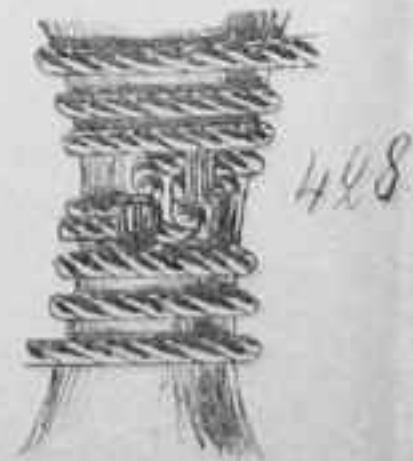
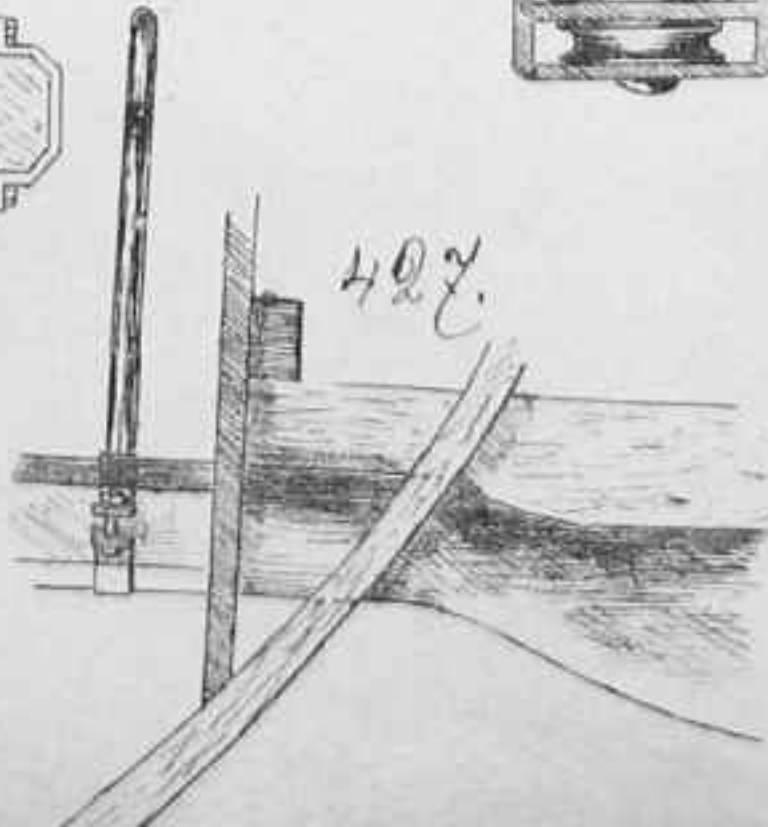
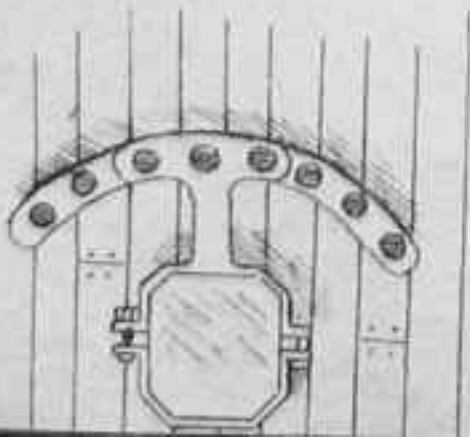

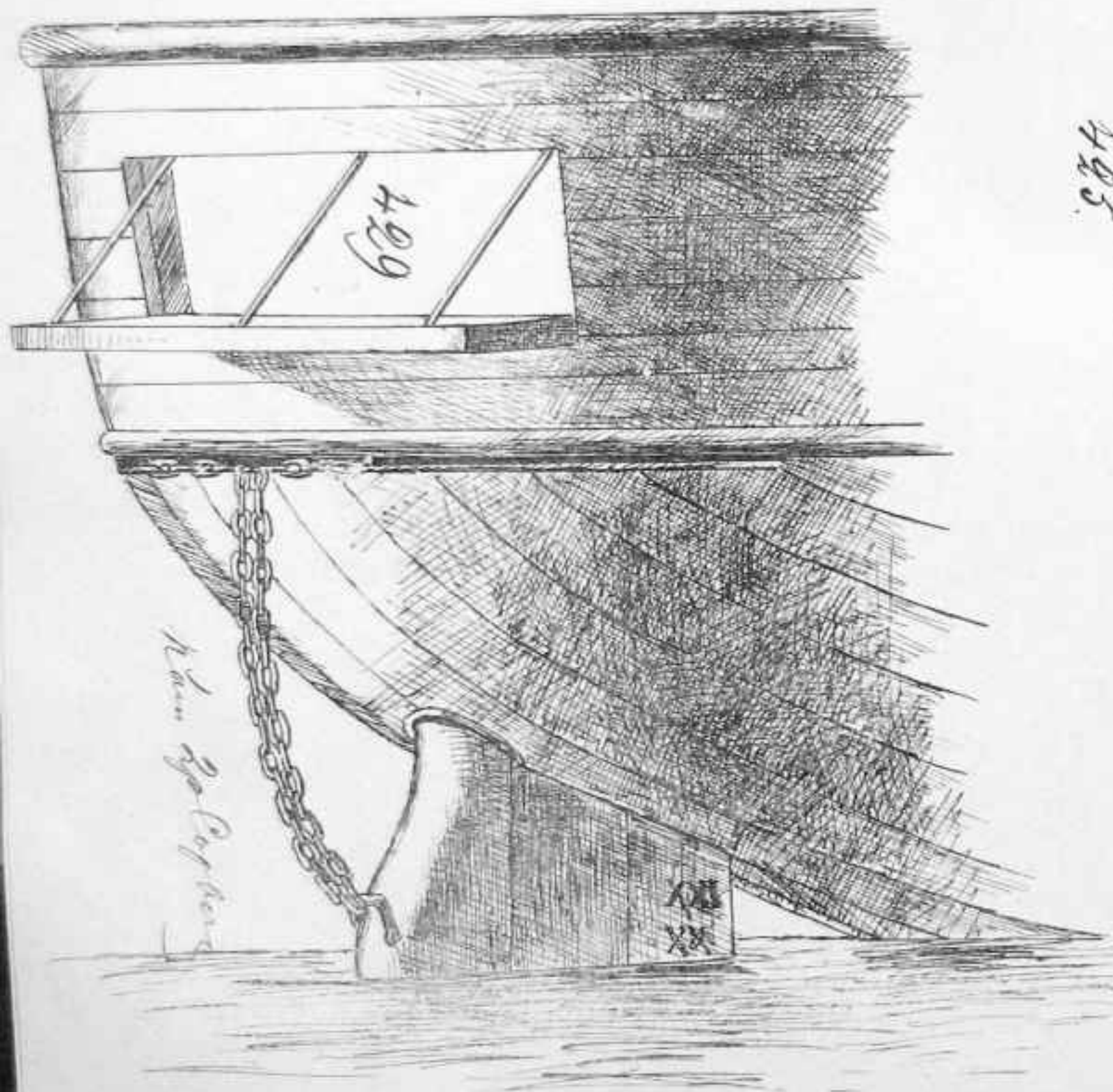

495.

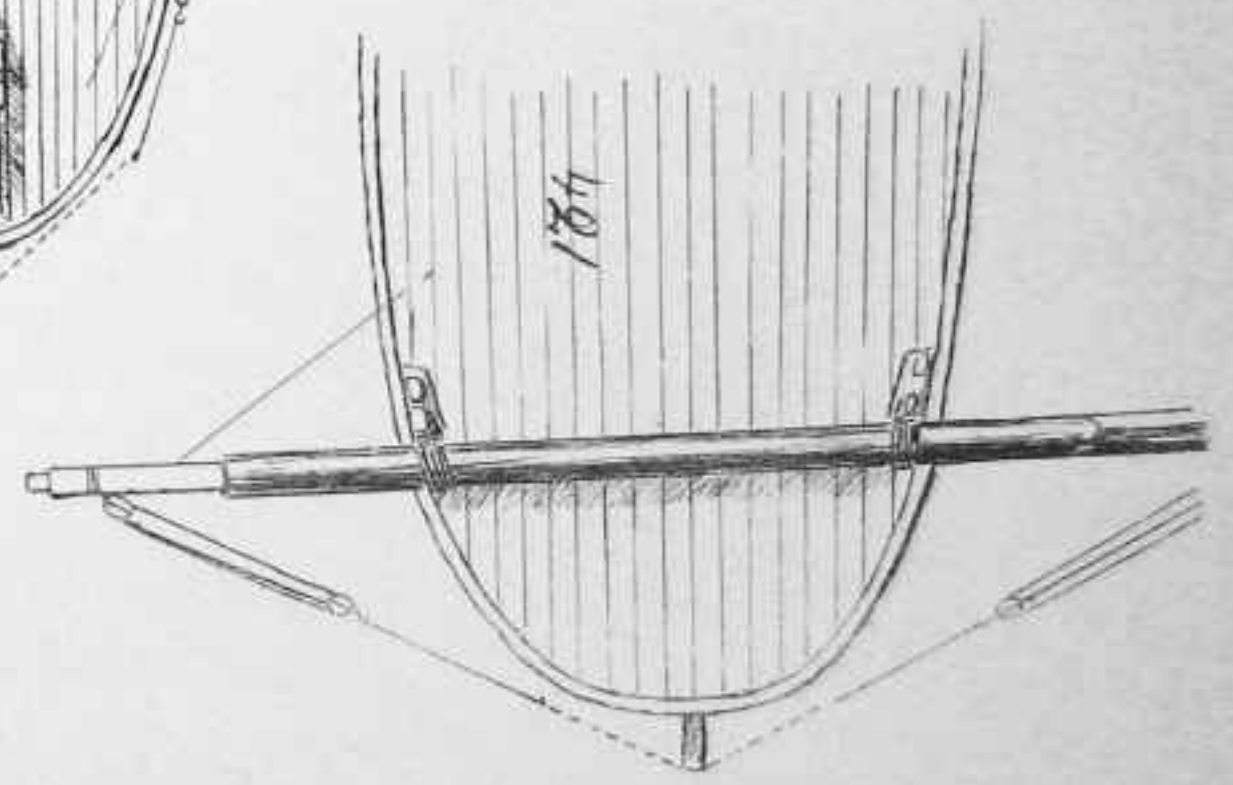
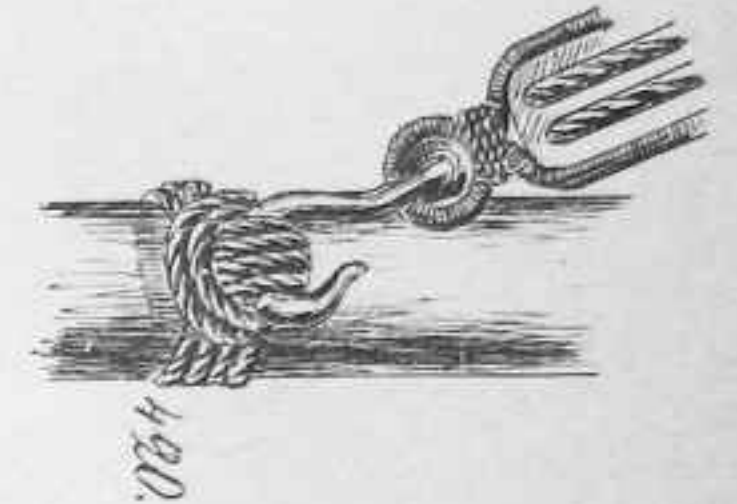
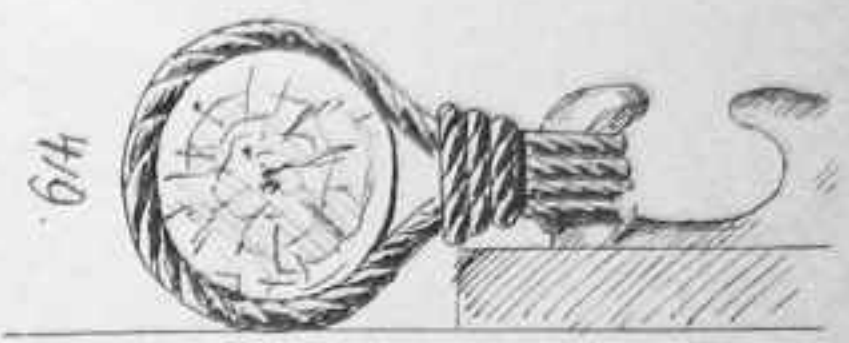
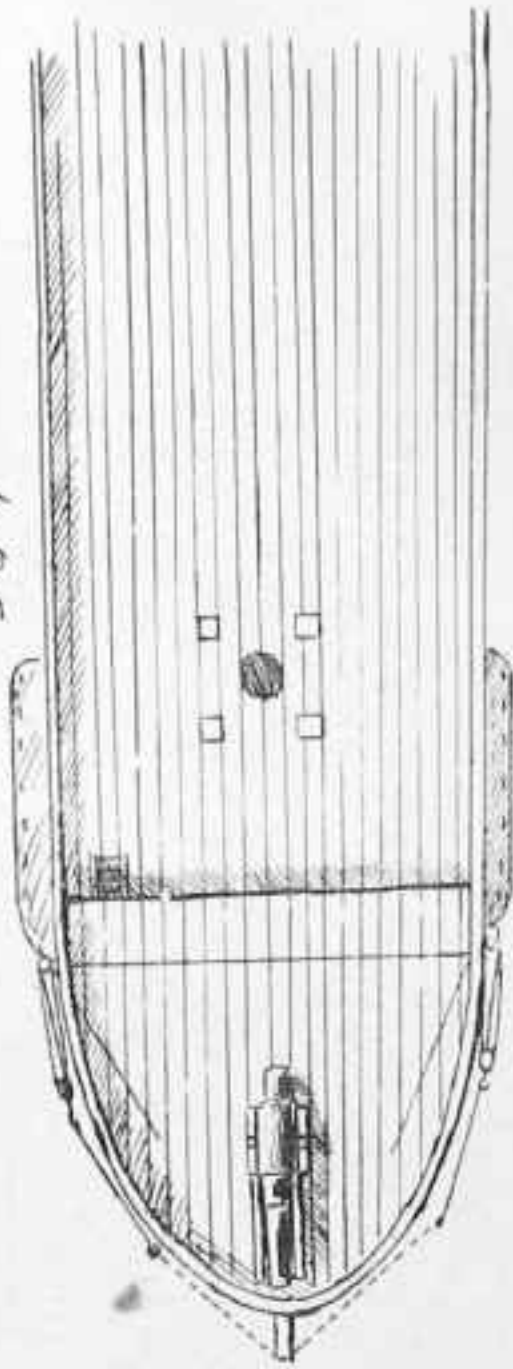

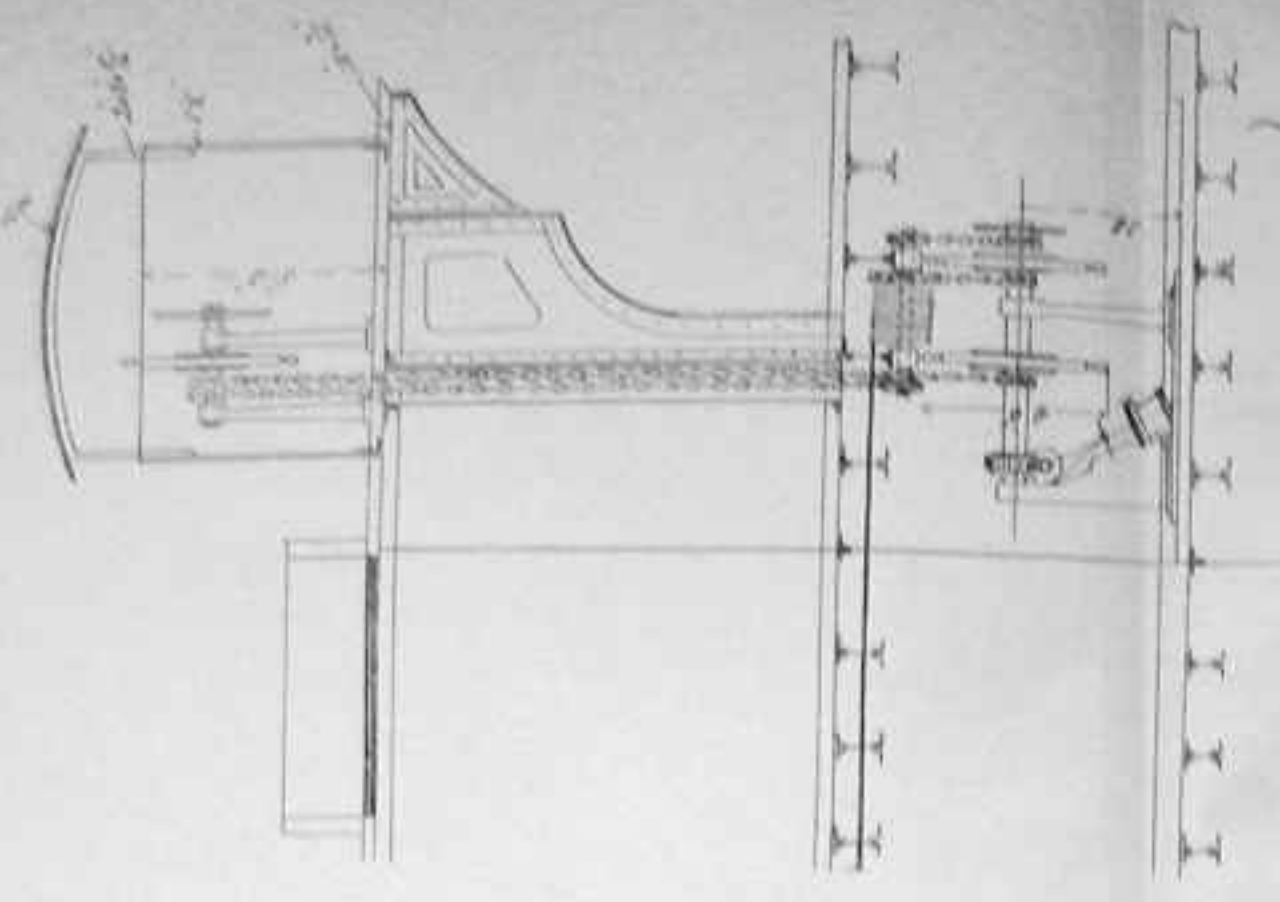
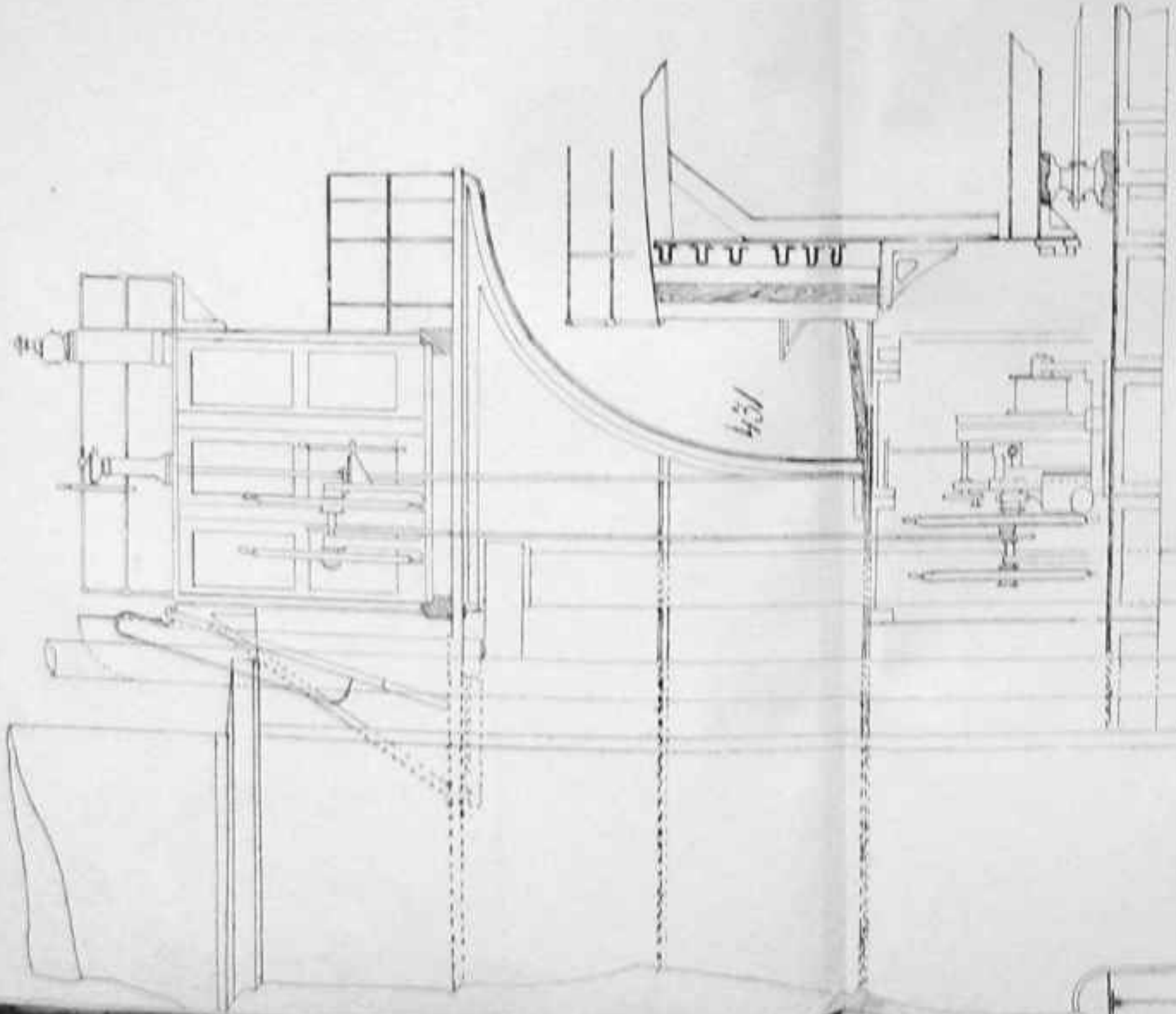

Abmessungen 1/2 Zoll

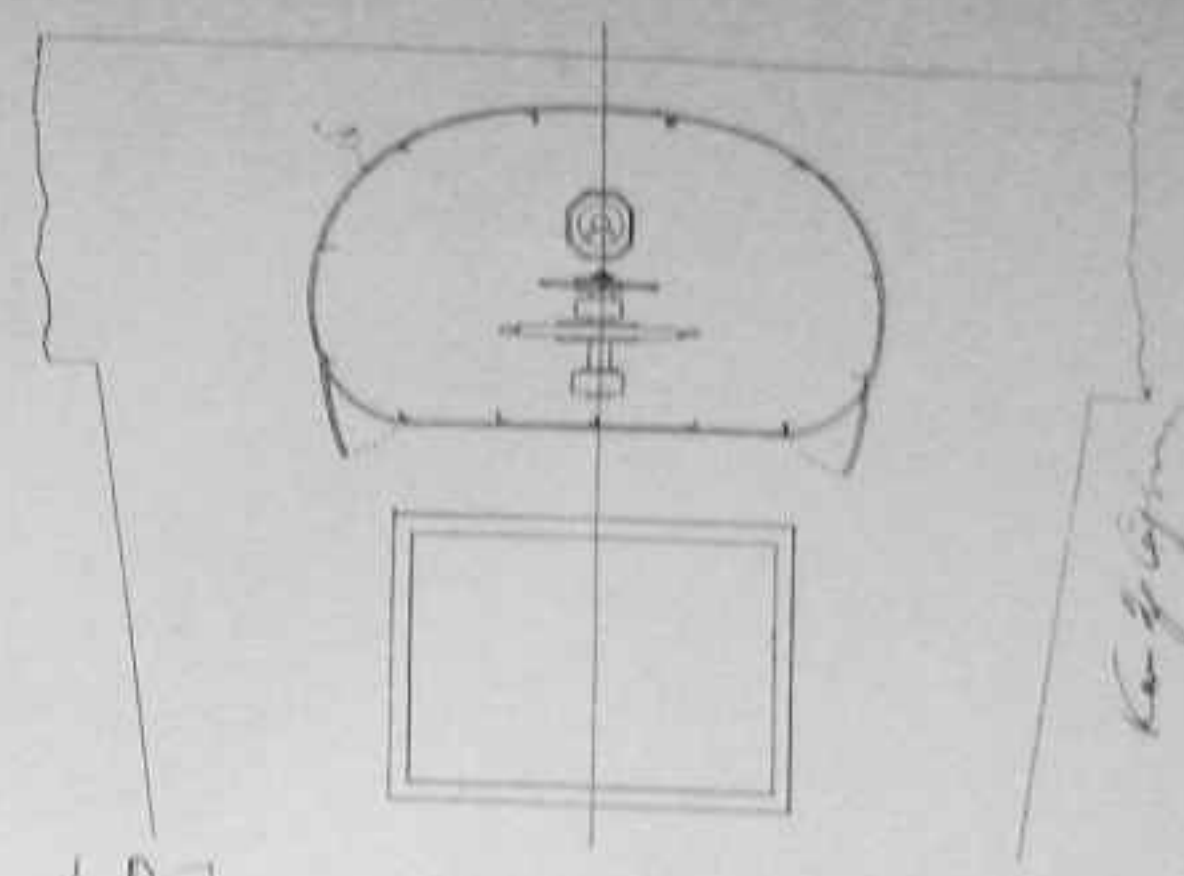

Keil-Loch

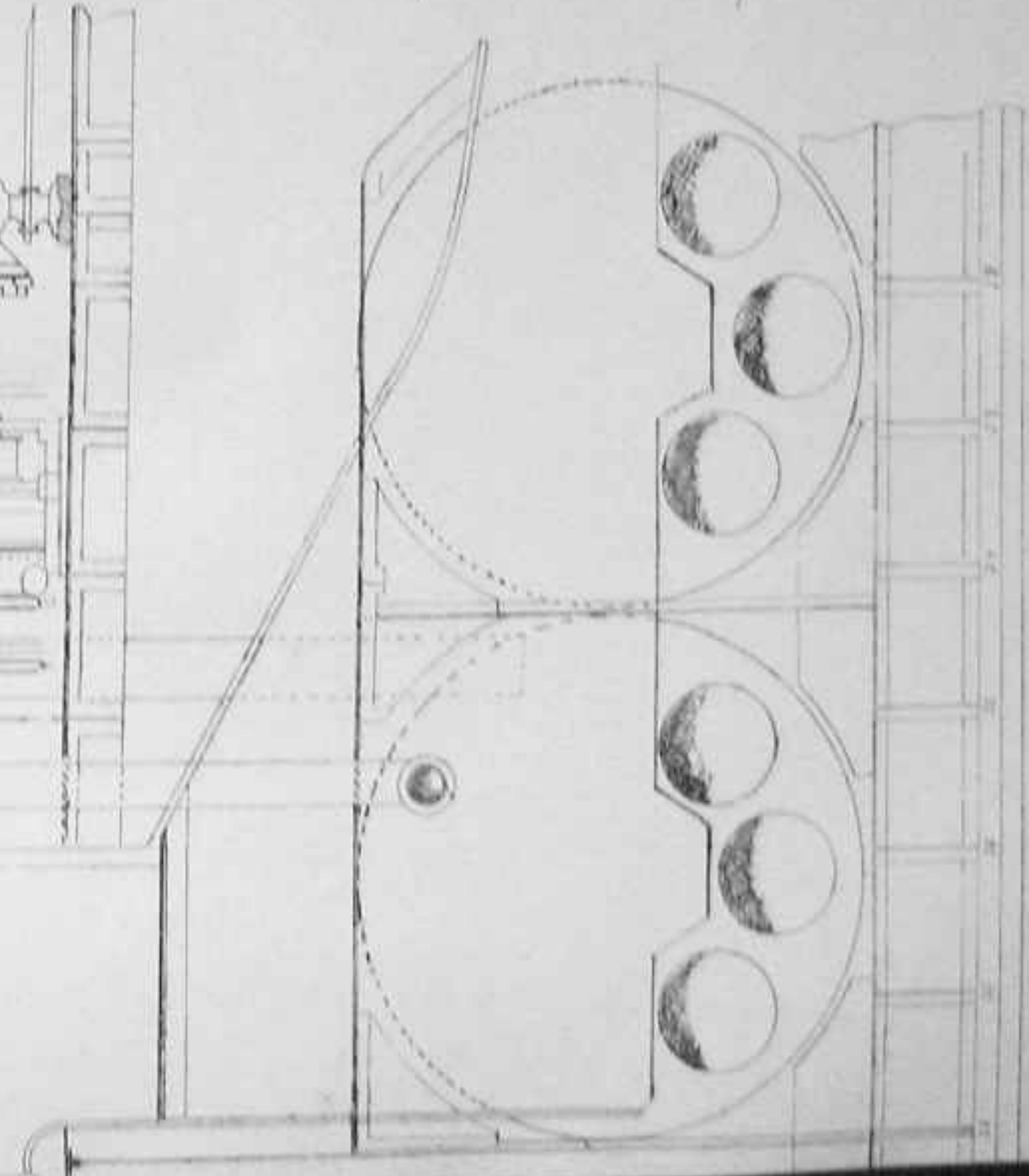

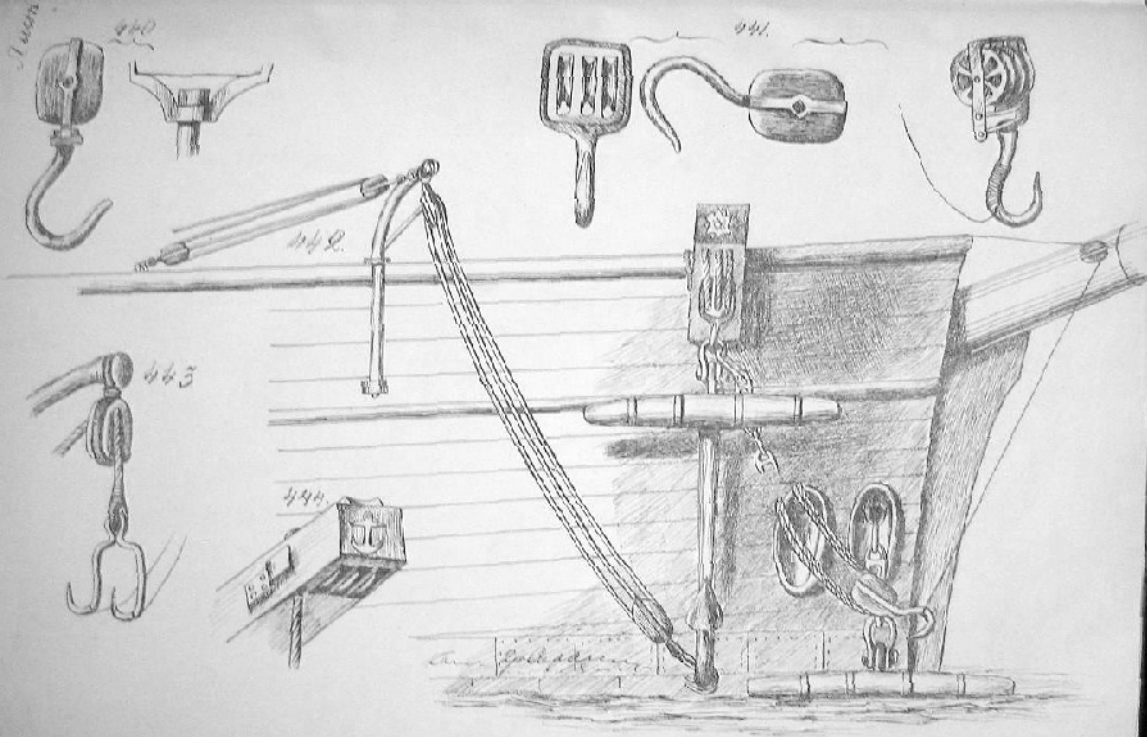

1 wire

440

441

442

443

444

Am. Goldschmidt

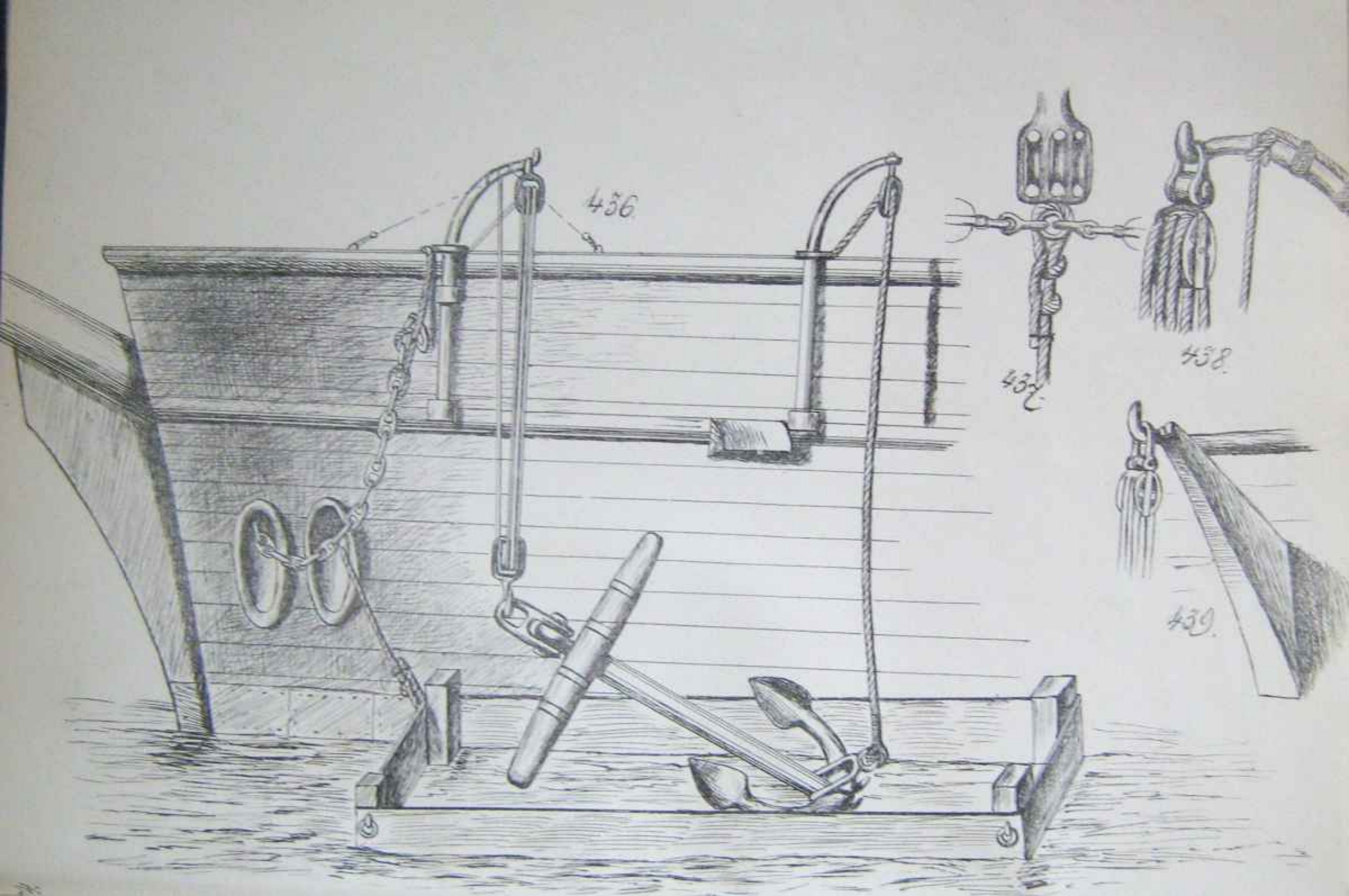

436

437

438

439

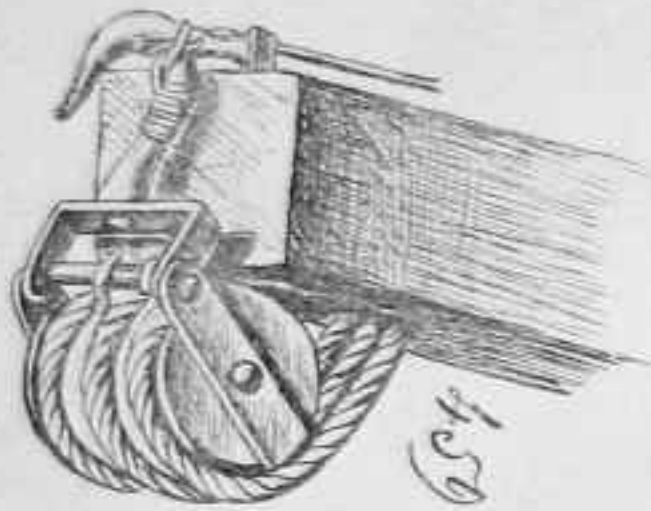

459

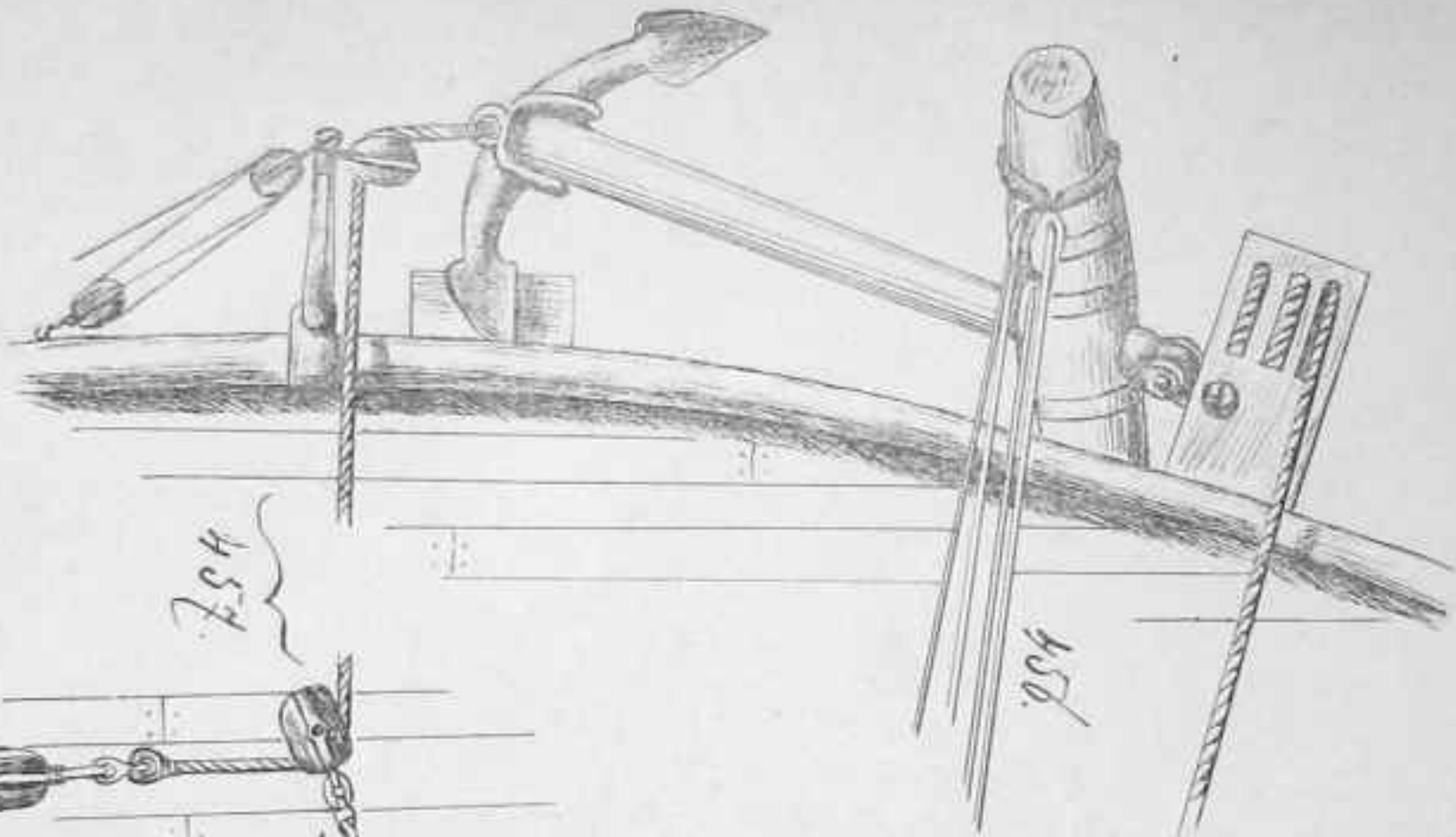

457

456



445

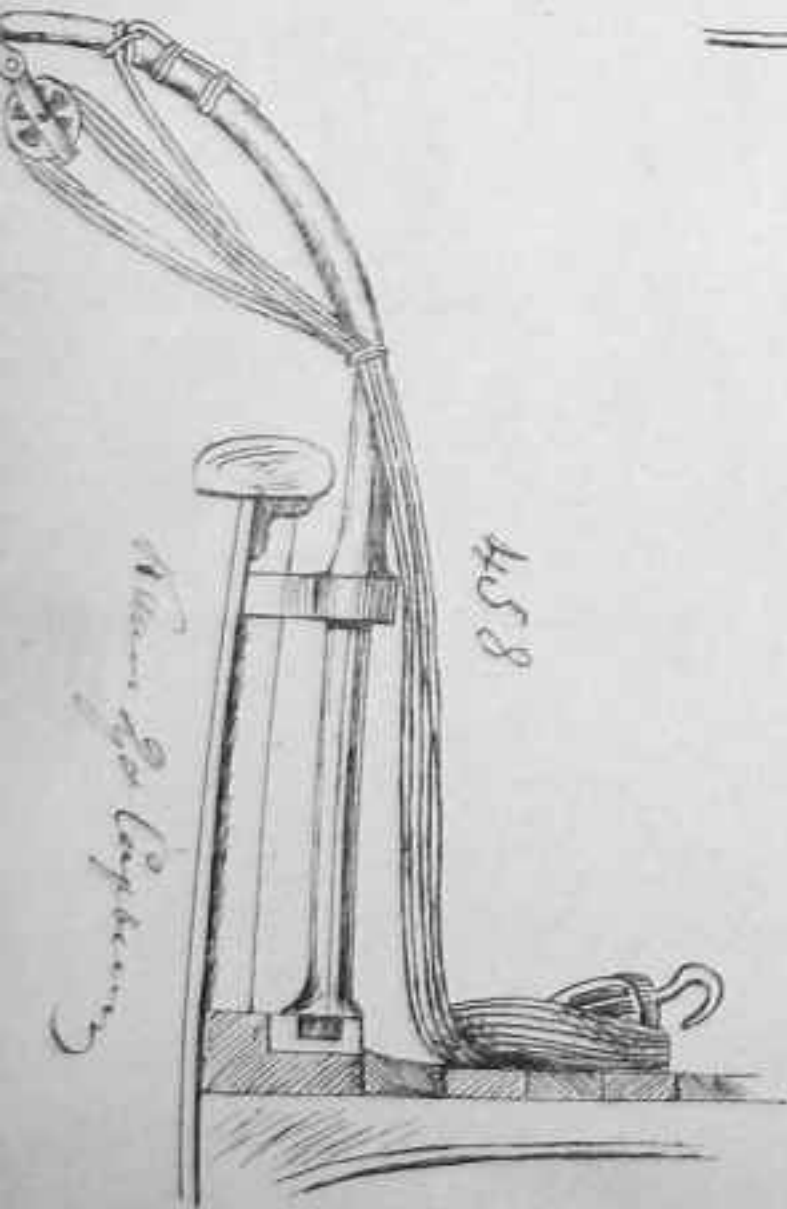

458

Machine for Lifting

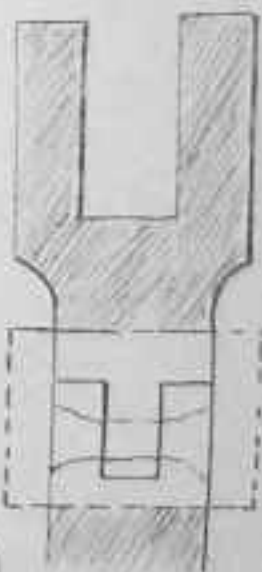
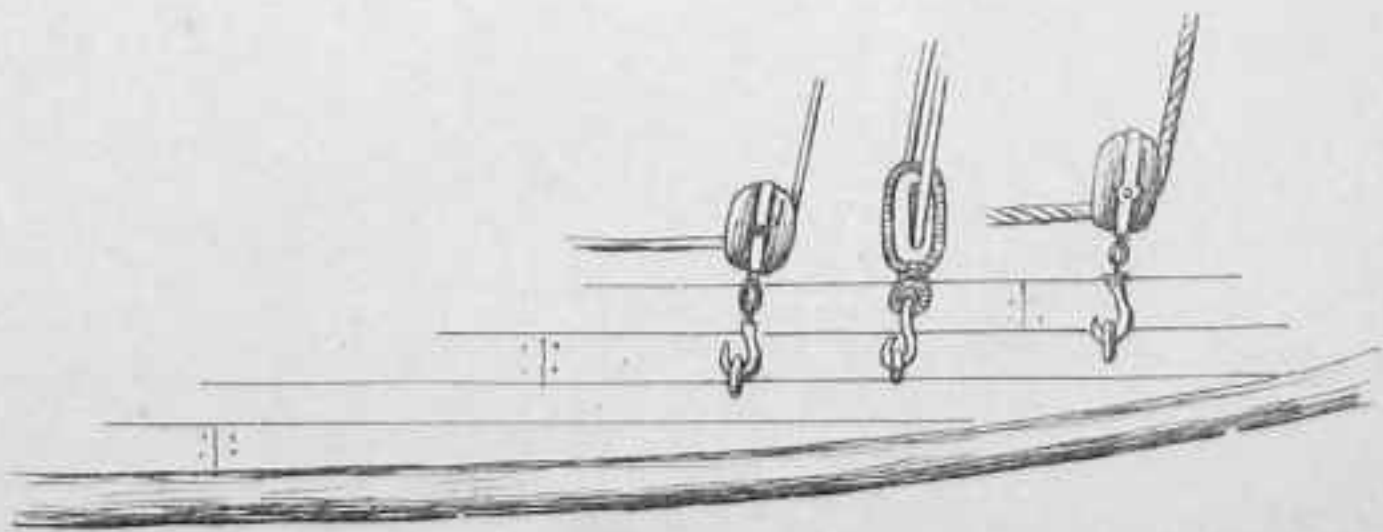
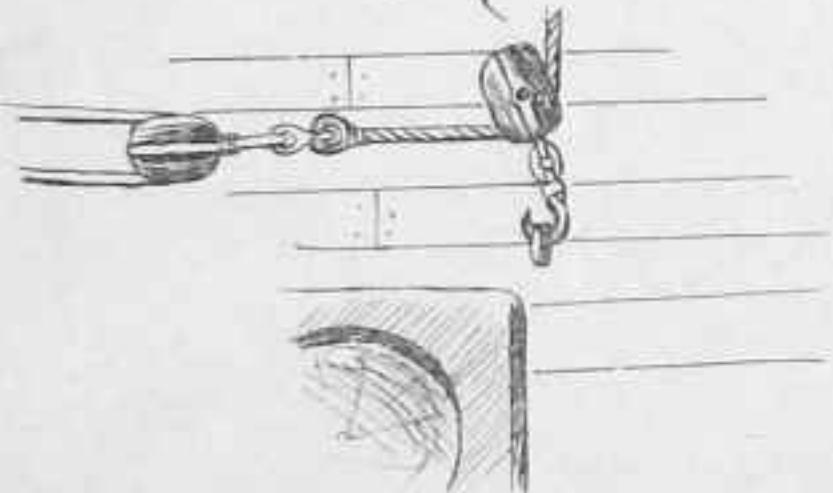

446



Machine 55

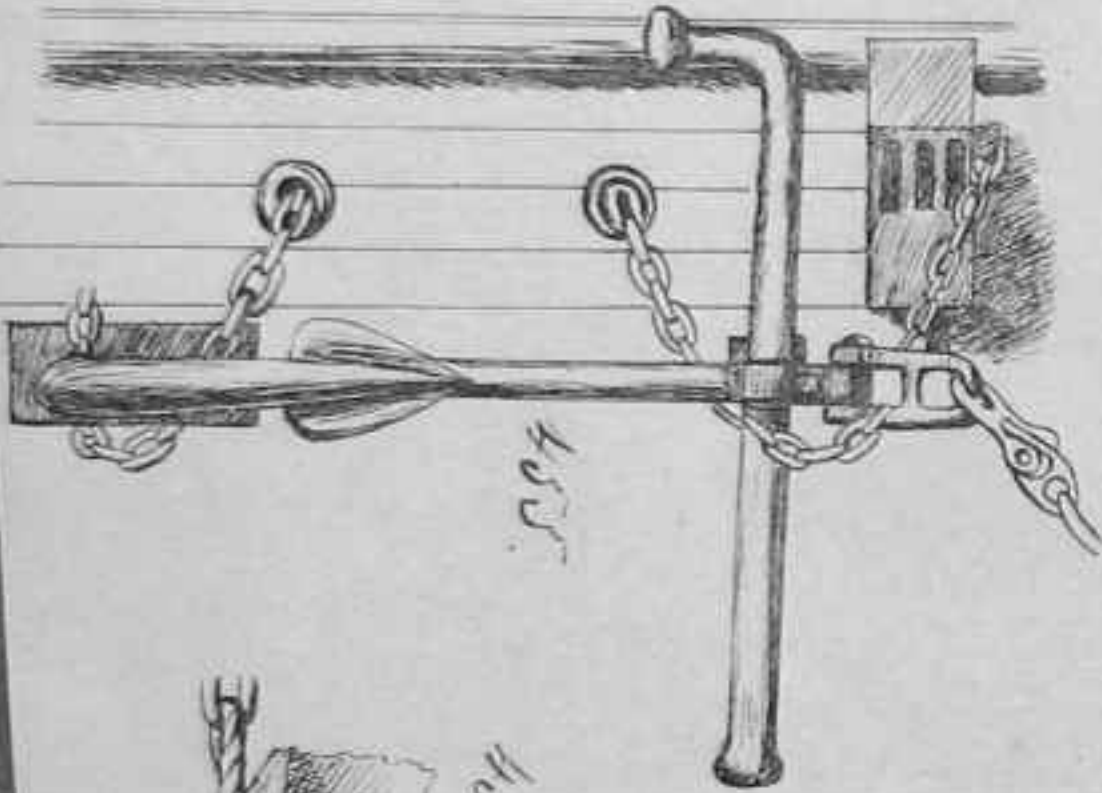
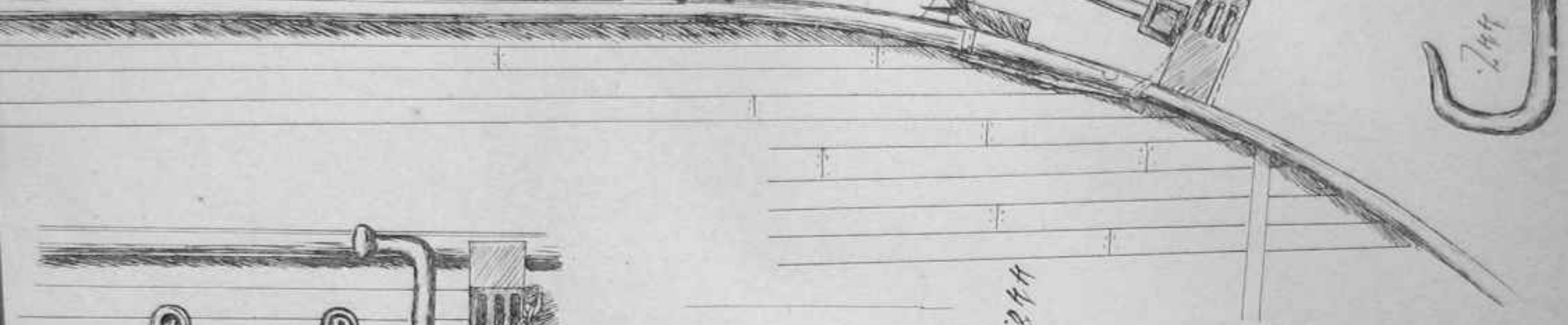
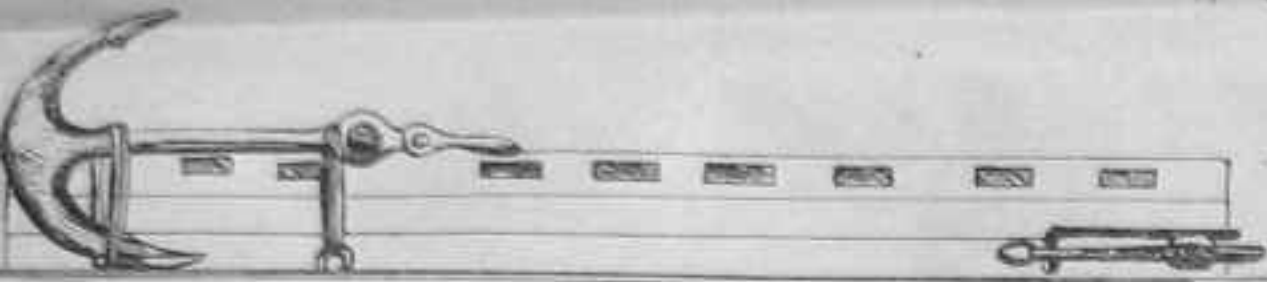

455

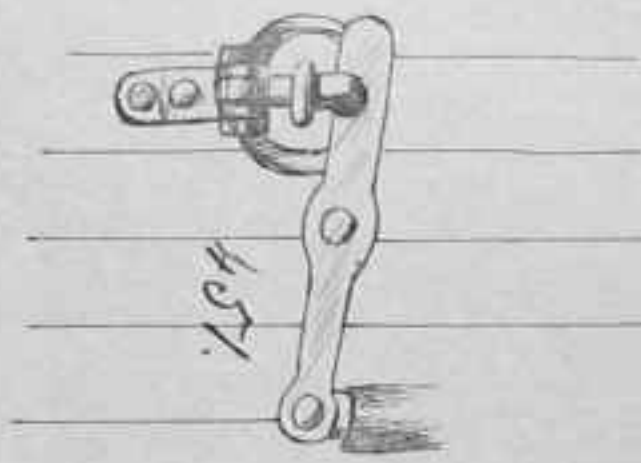

457

448



450

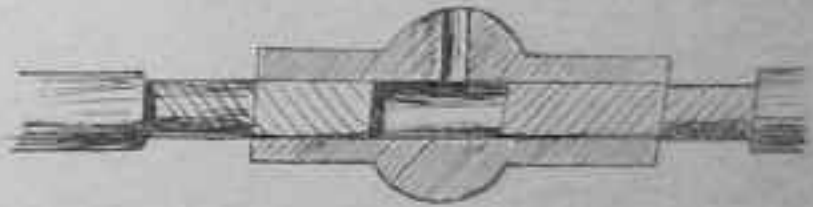

449

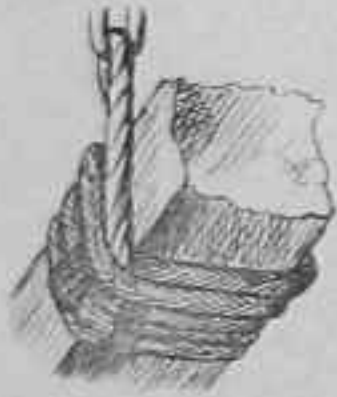

454

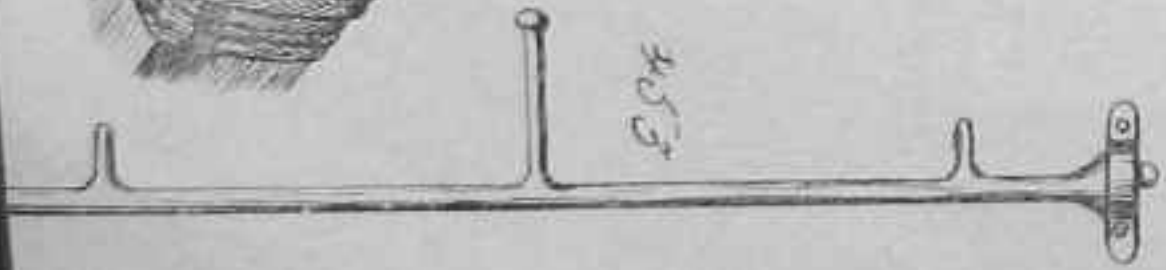

453



454

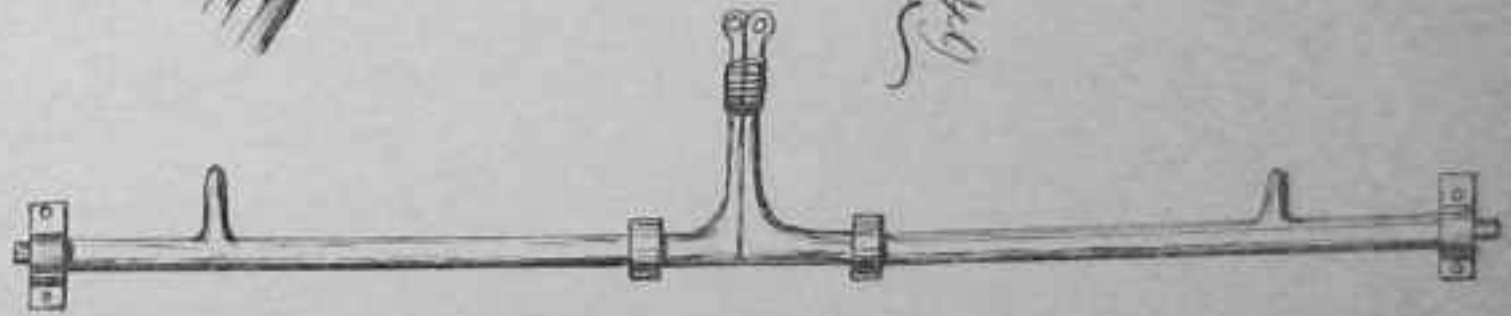

449

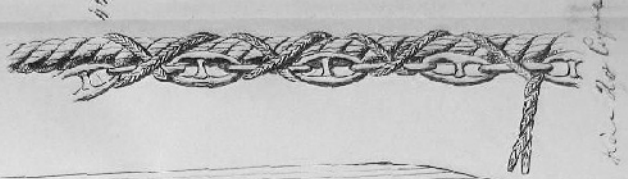

Side of the Rope

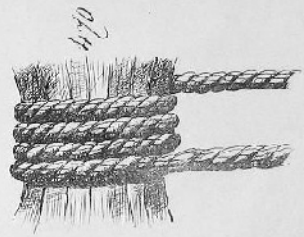
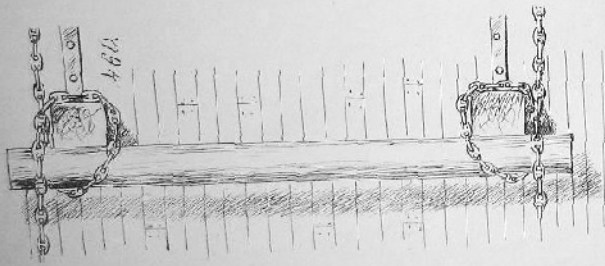
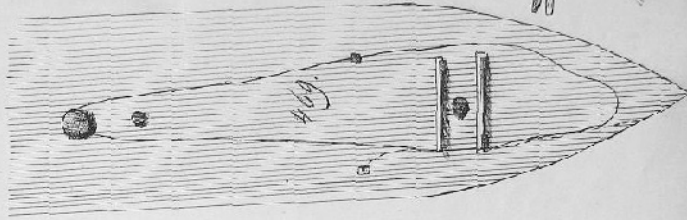
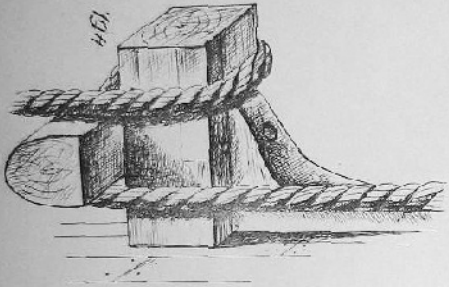

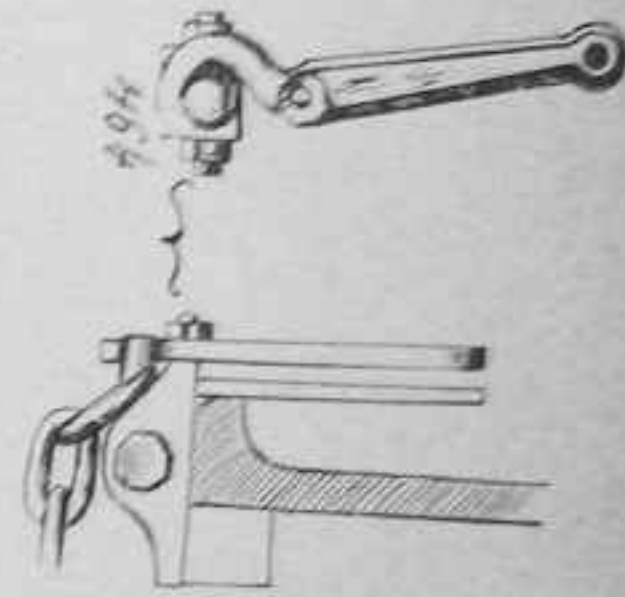
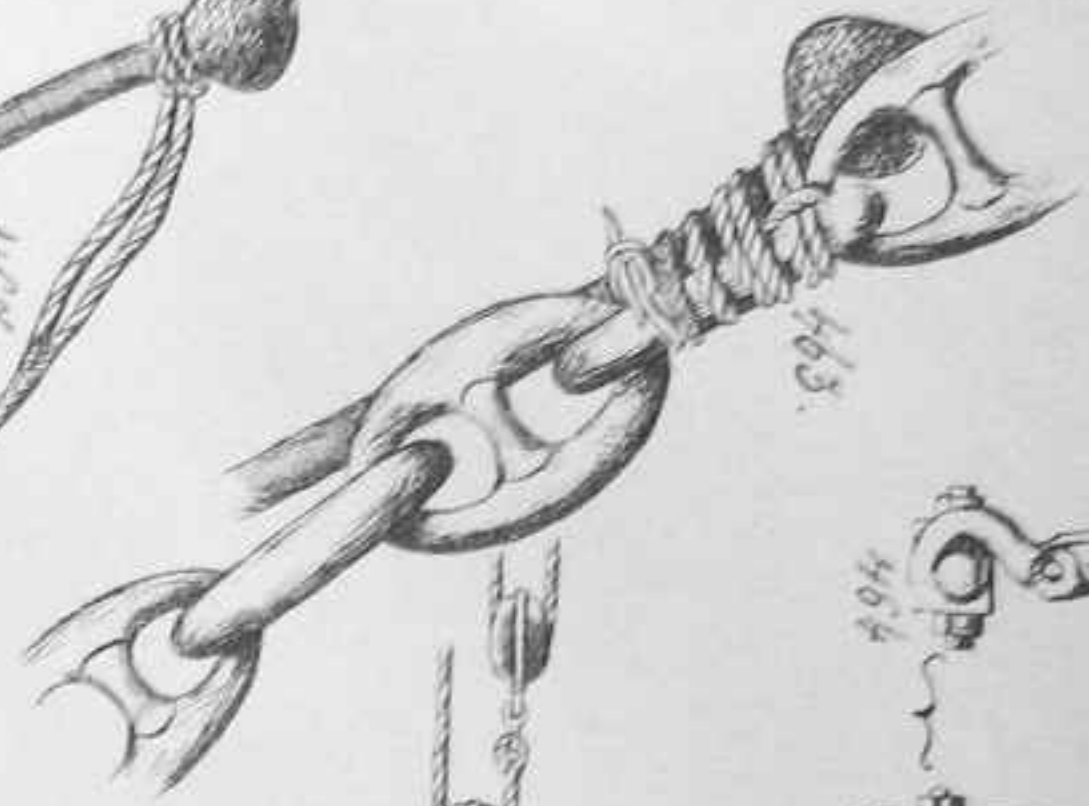
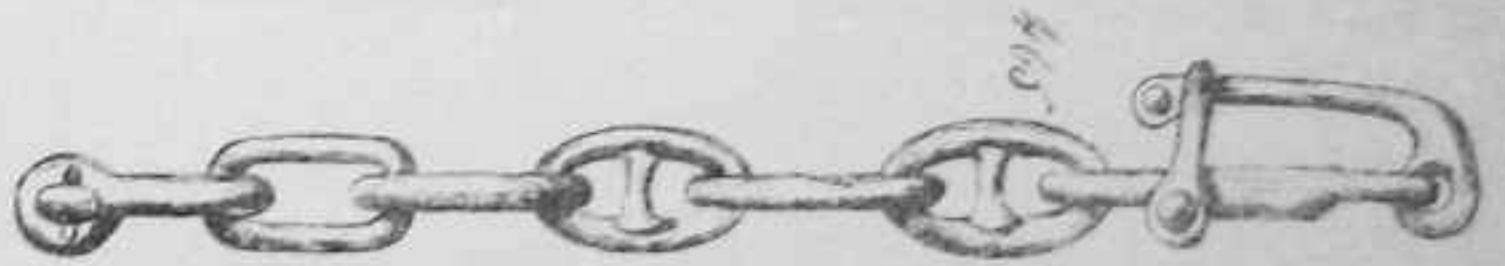
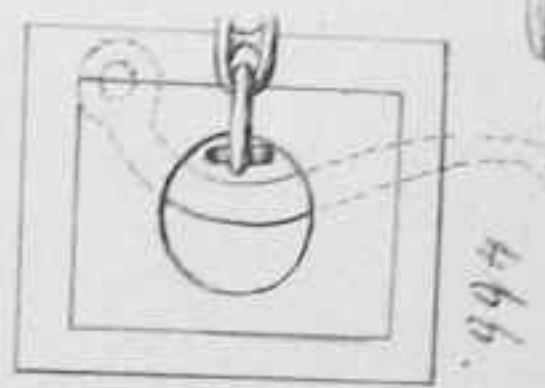
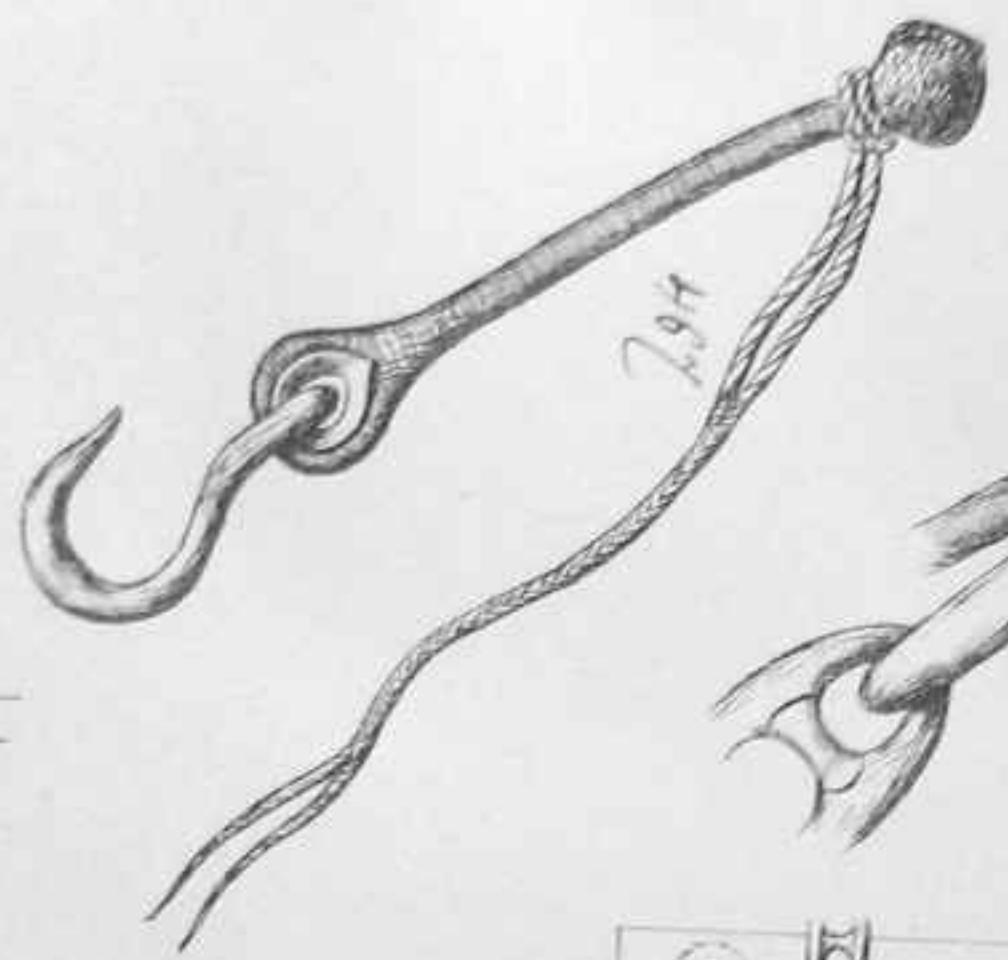
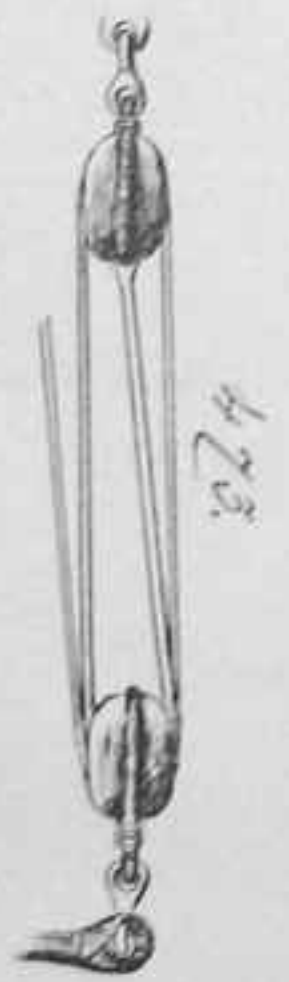
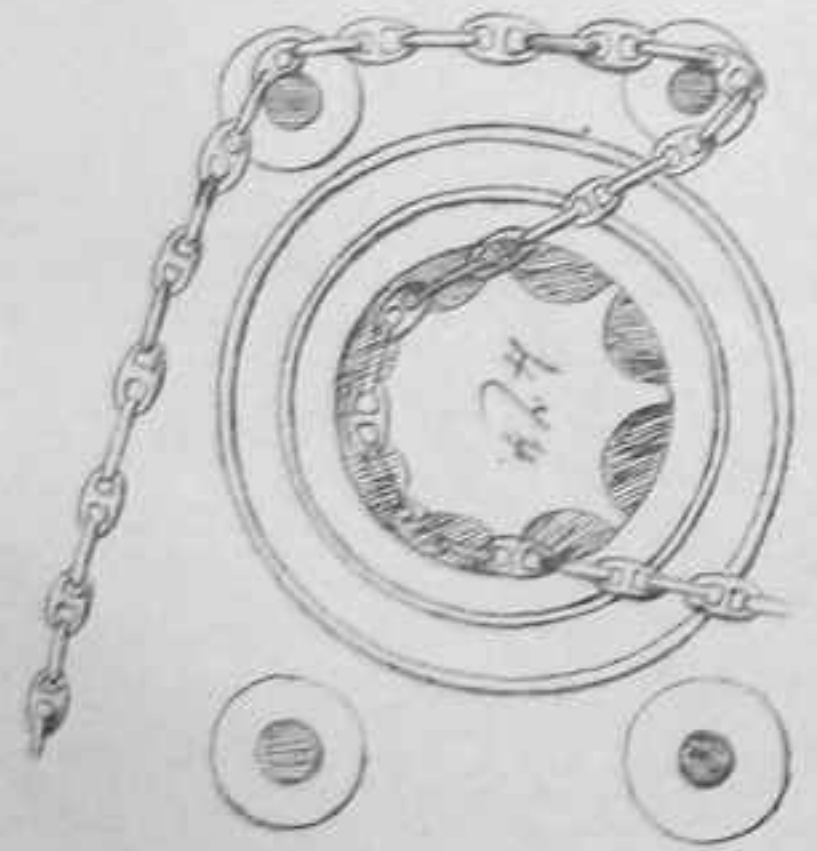
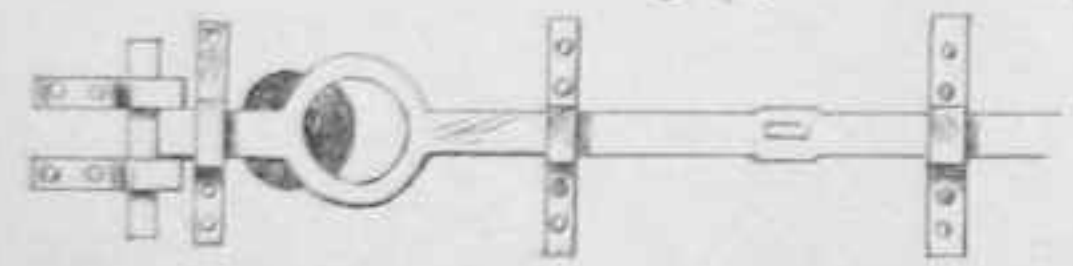
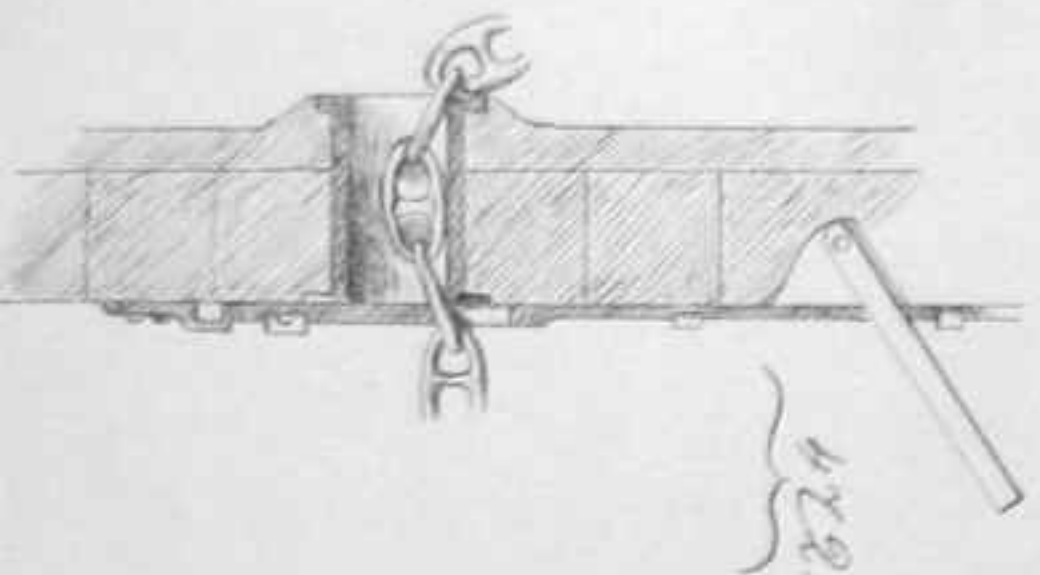

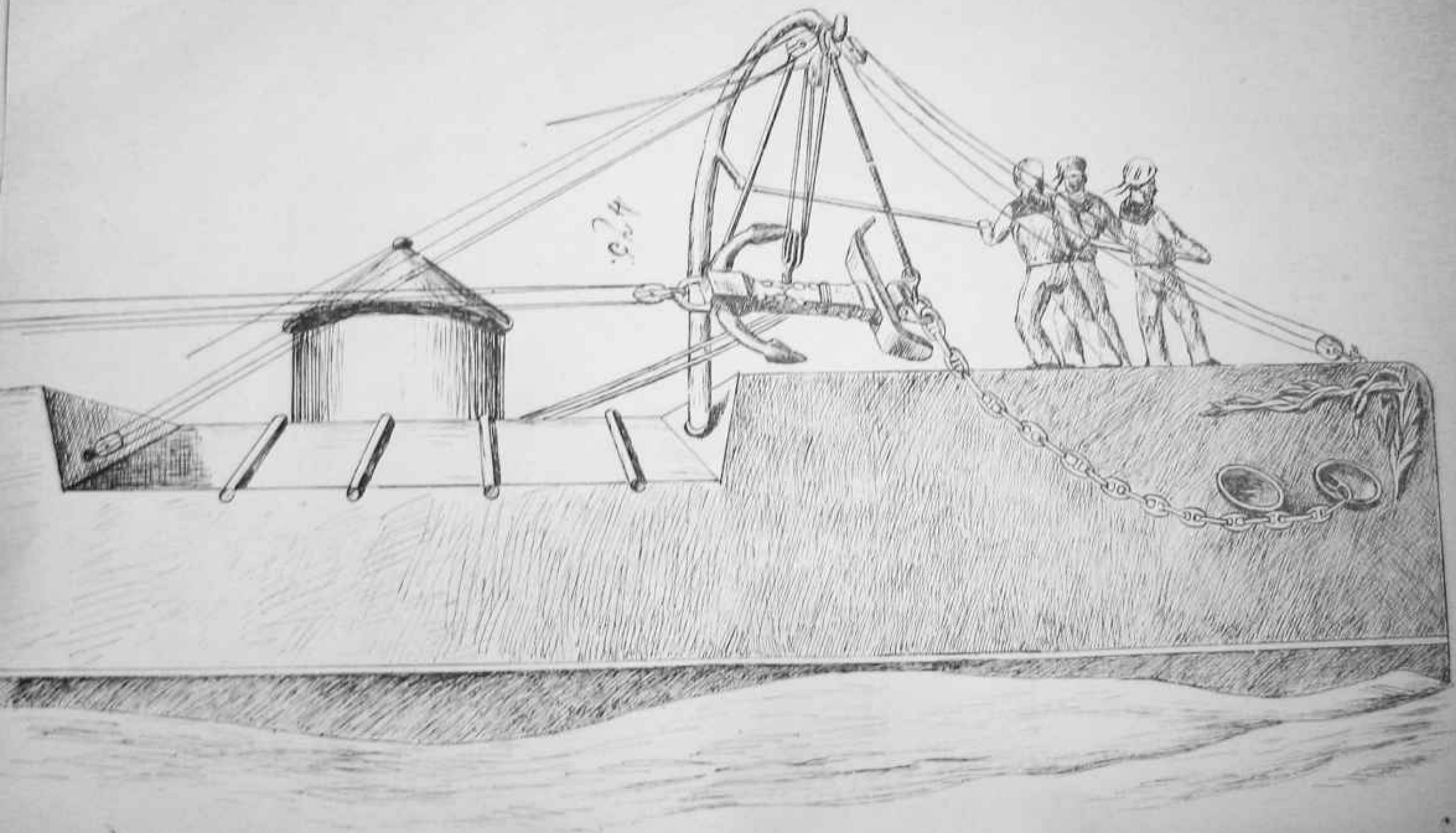
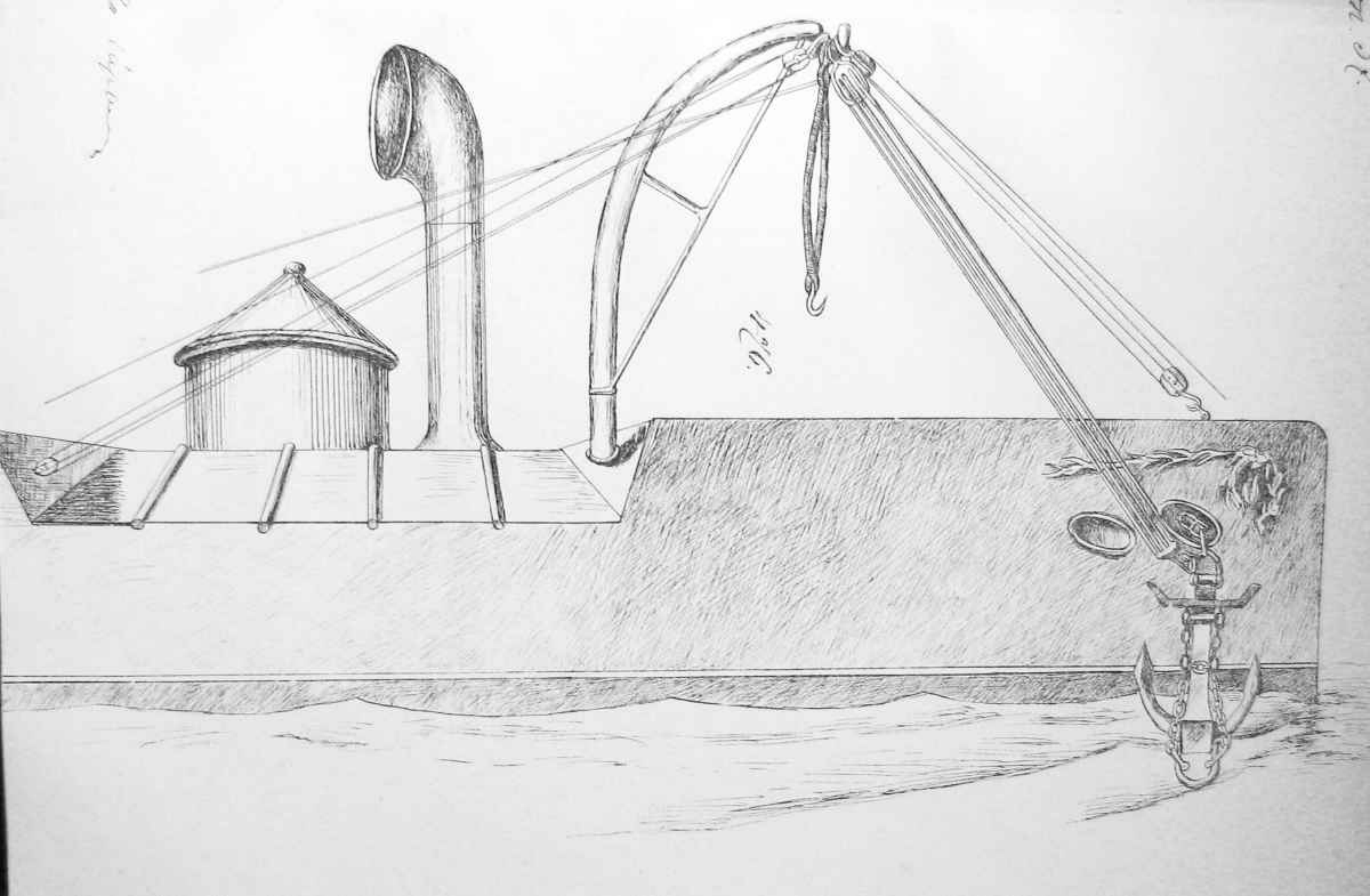

Fig. 4.

Fig. 5.



to capstan

1871

1876

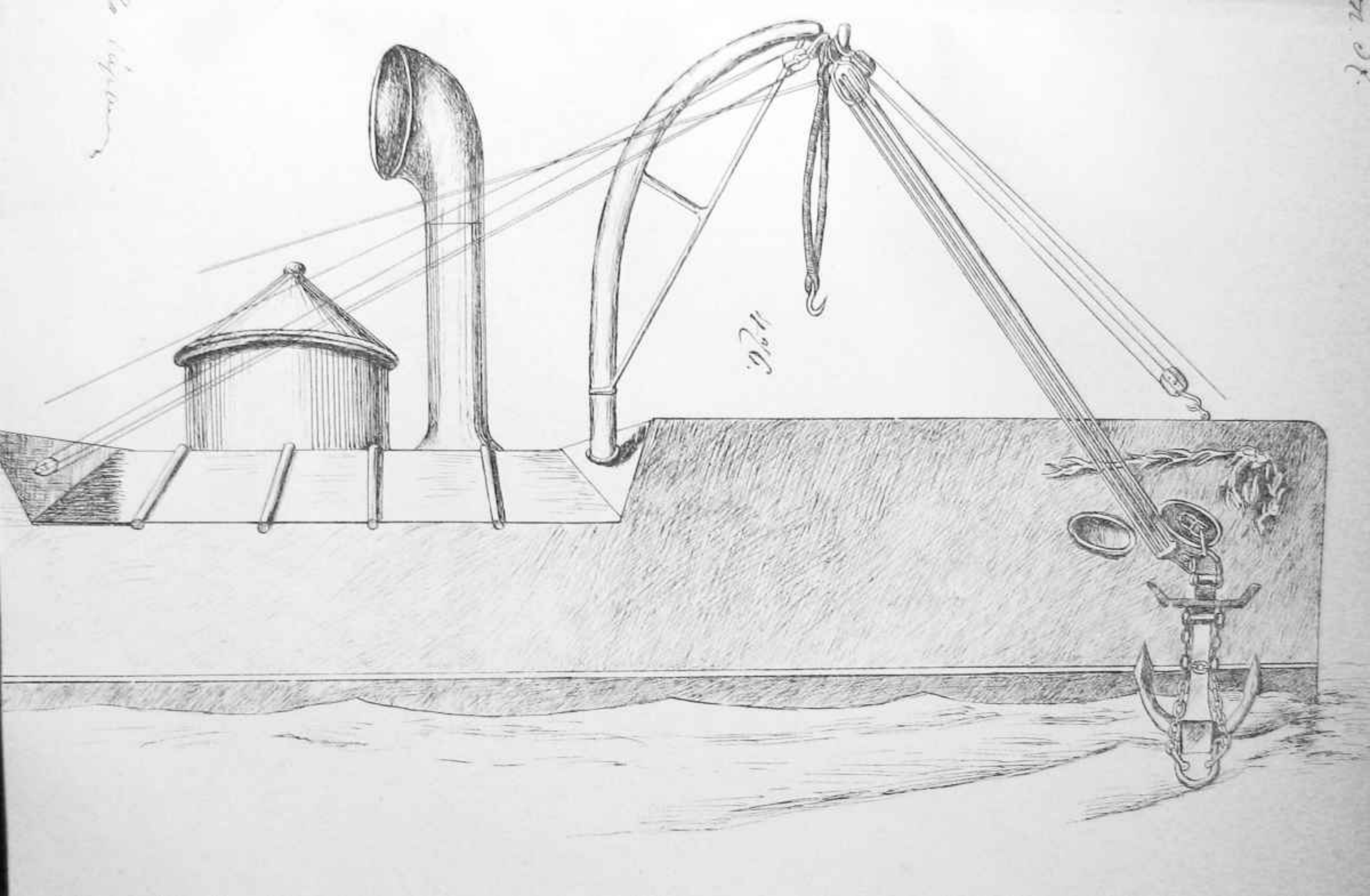

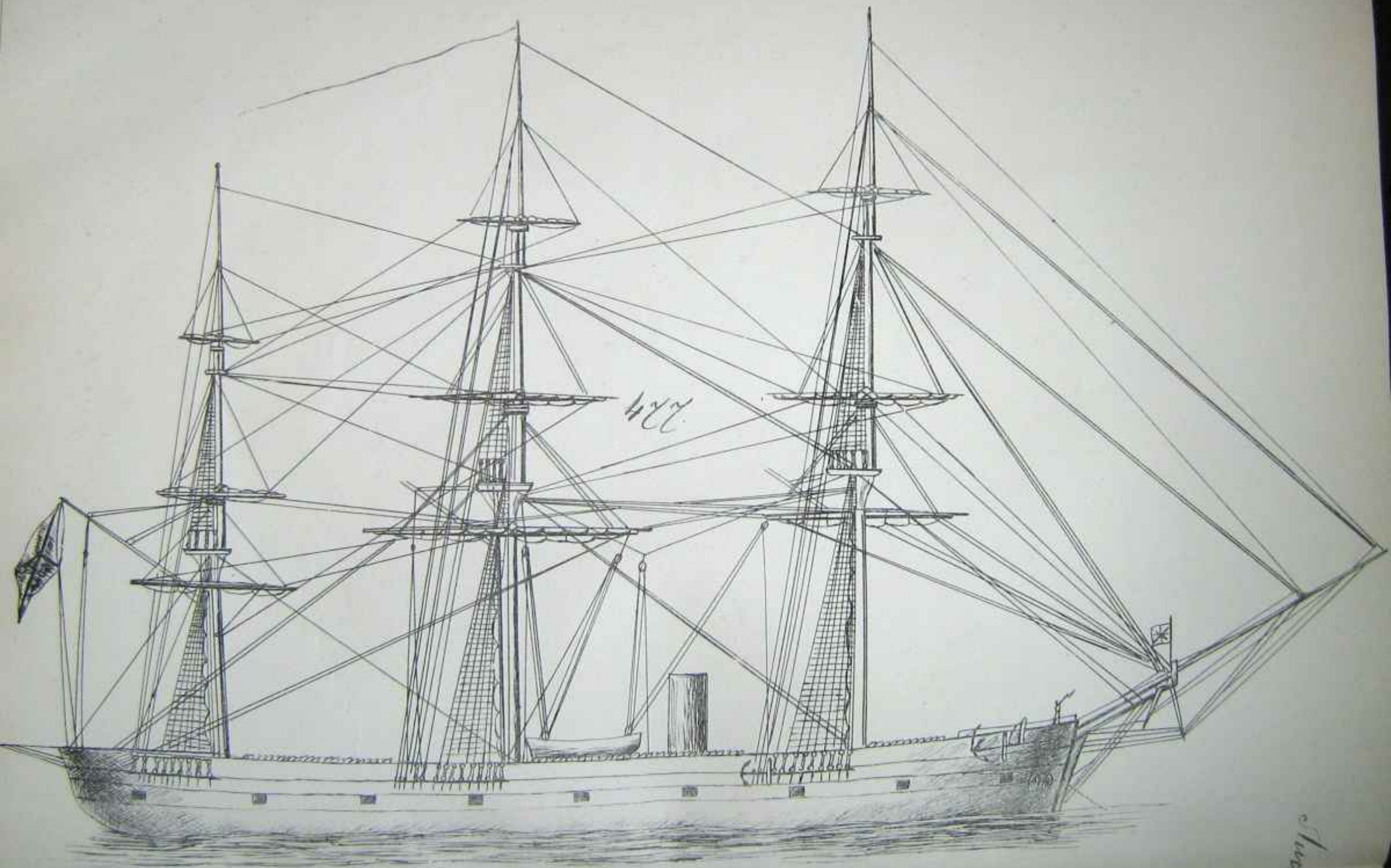

Plan 58

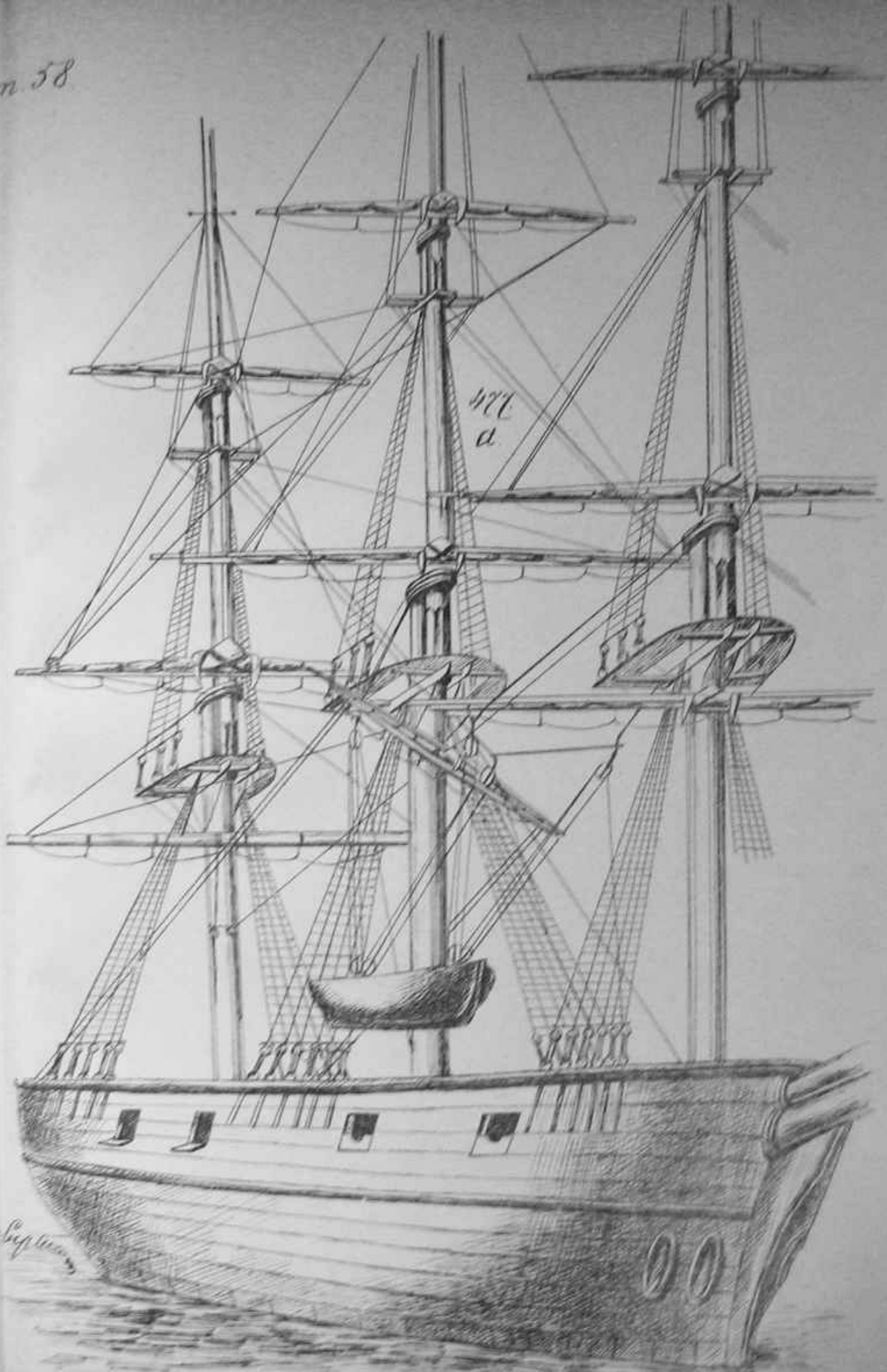

W.C.
d.

J. G. S. 1810

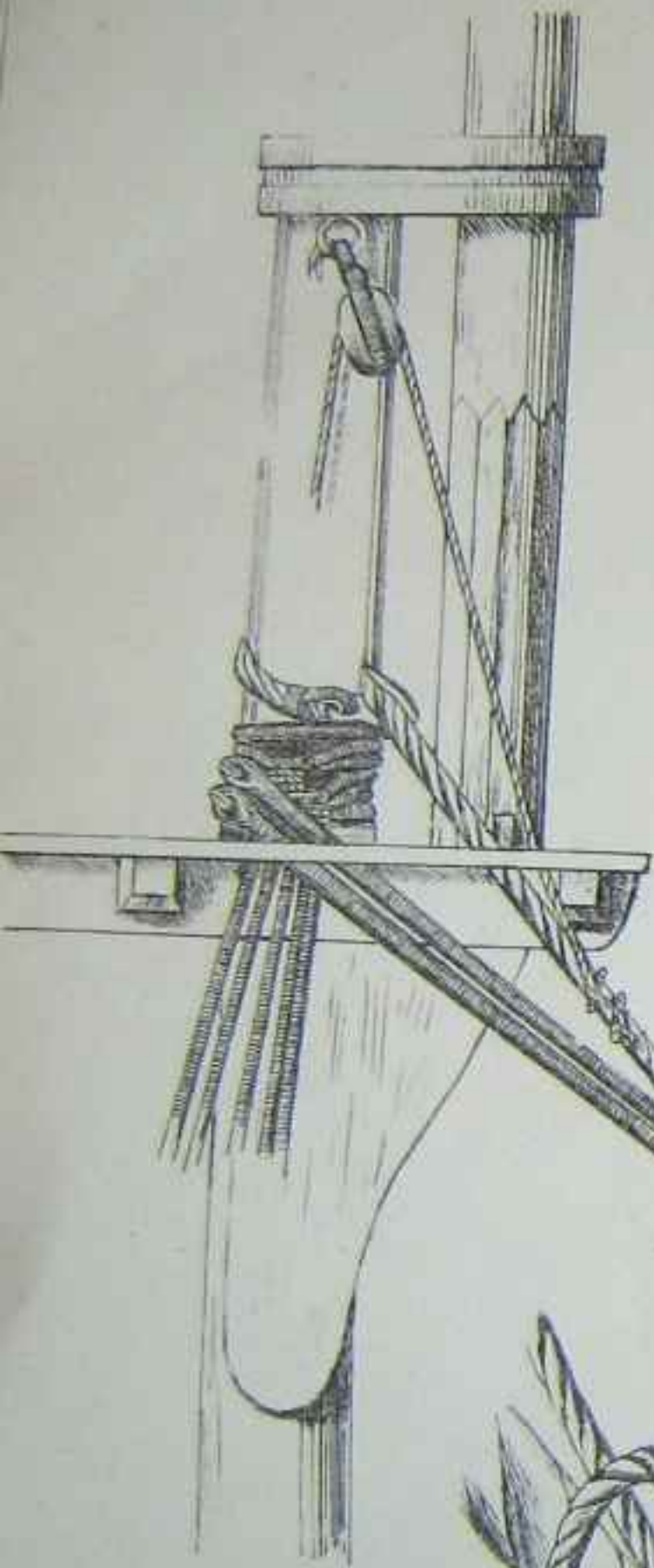

485.

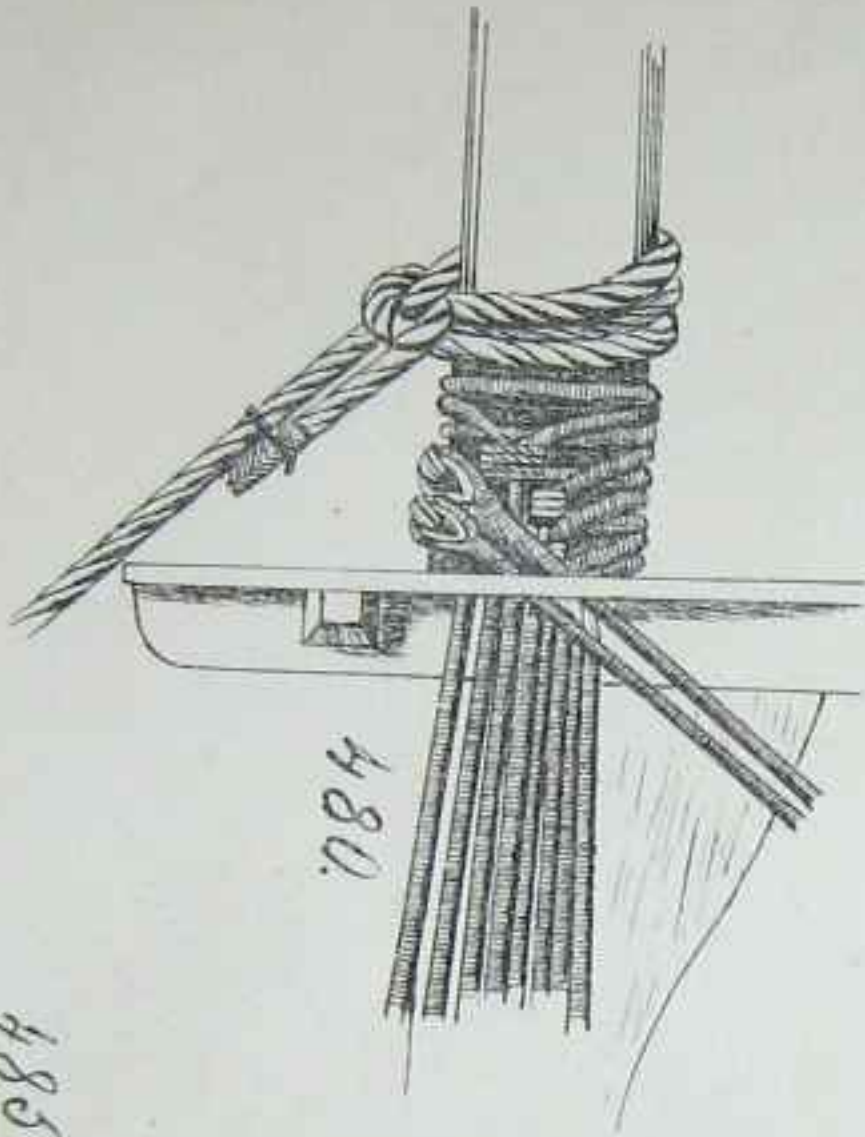

480.



484

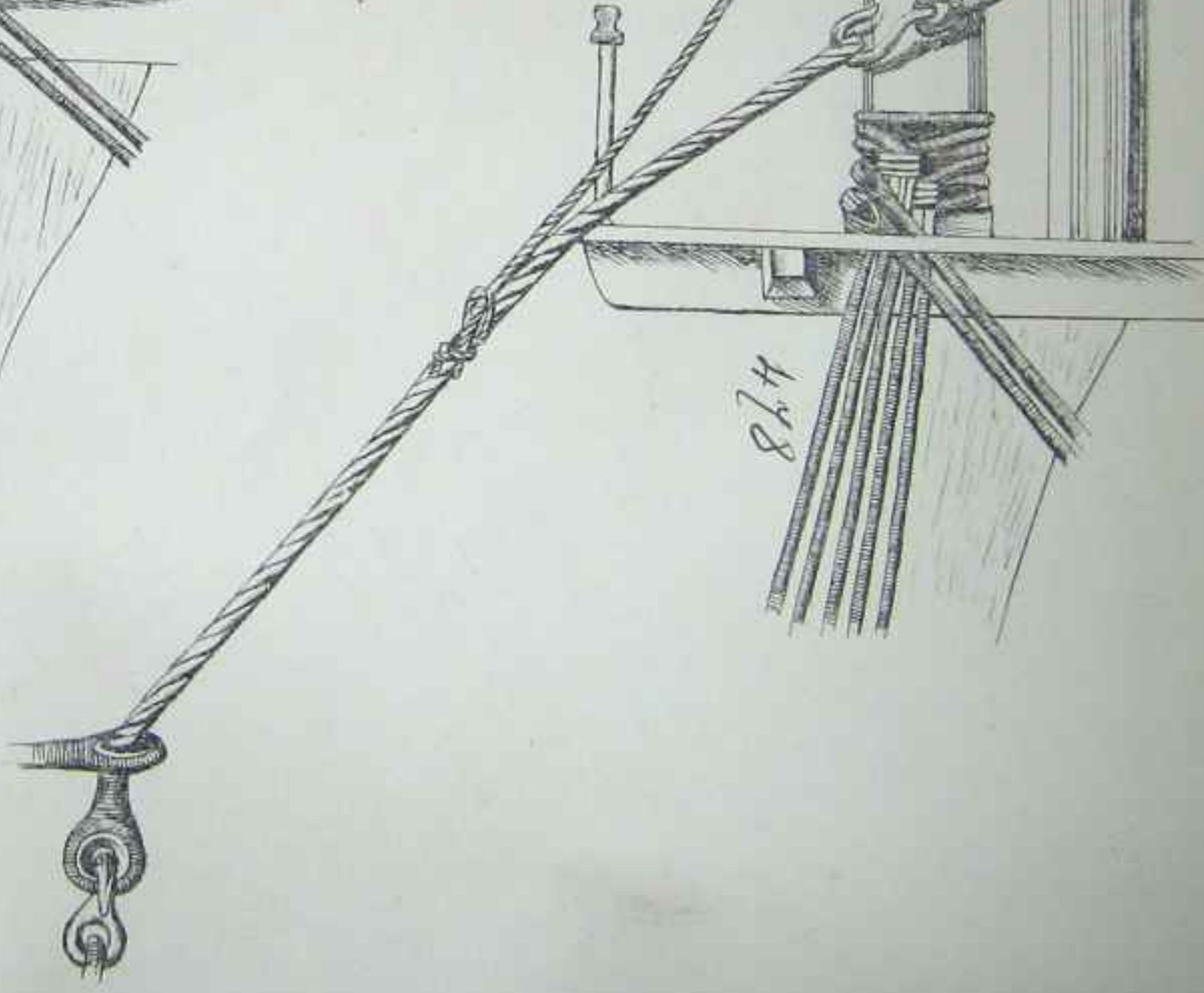

487



From the Captain

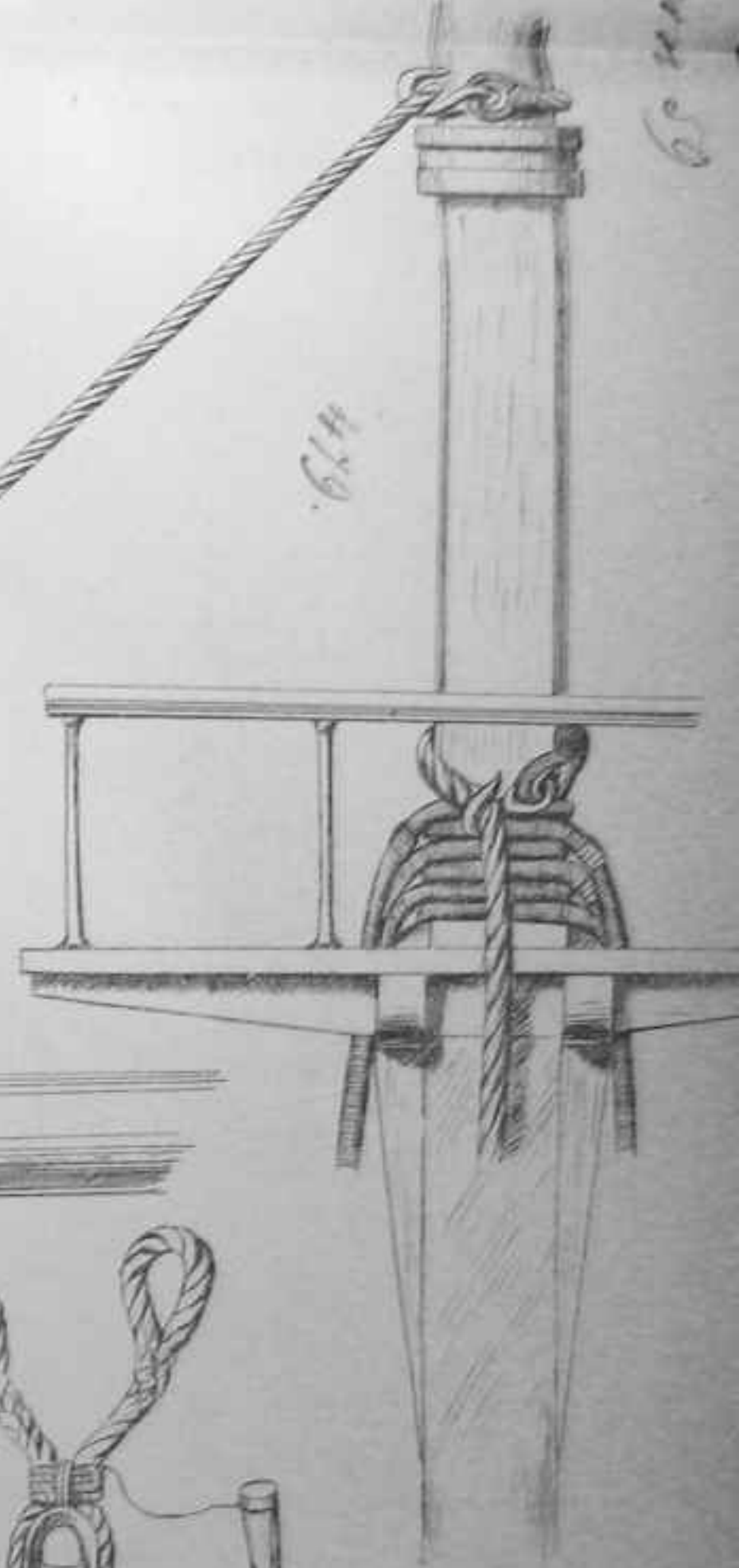
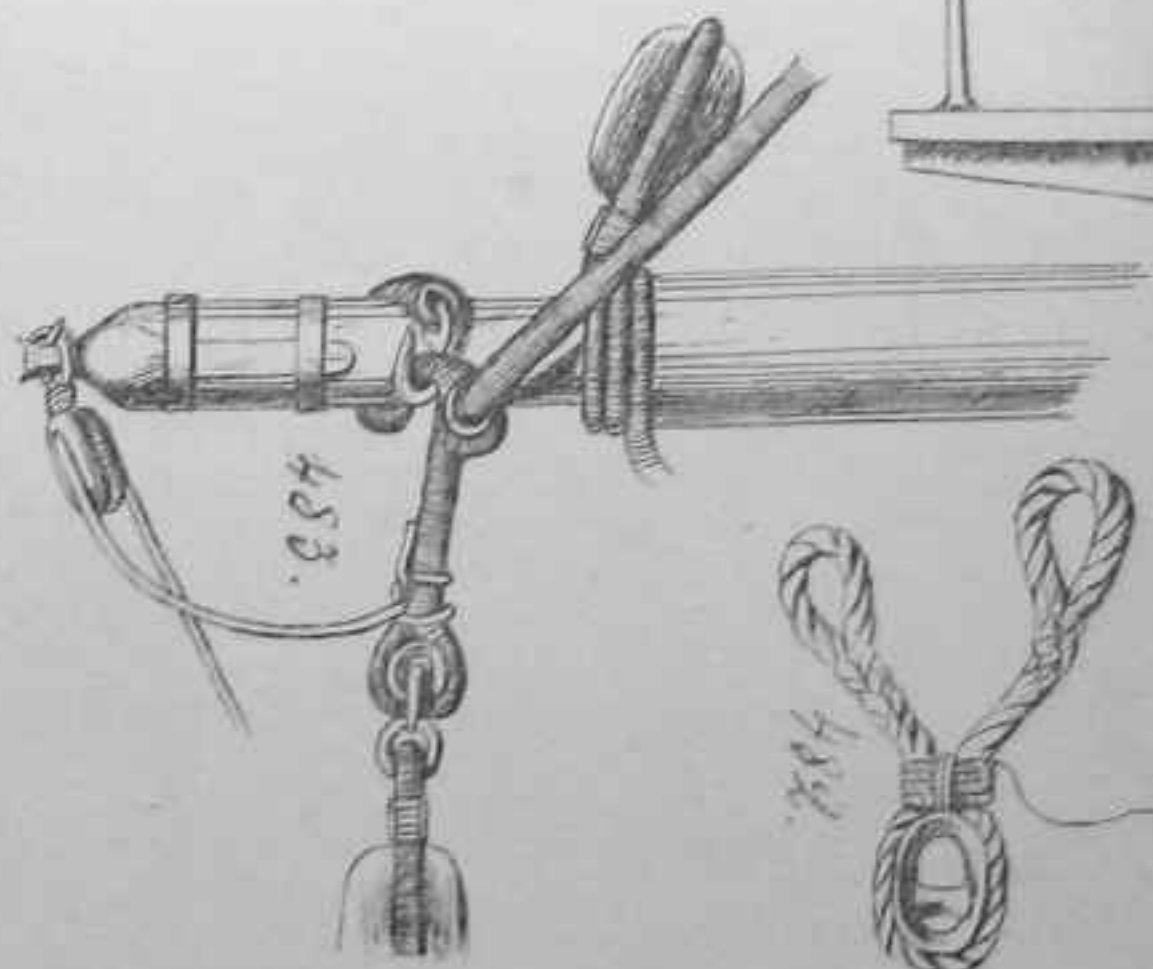
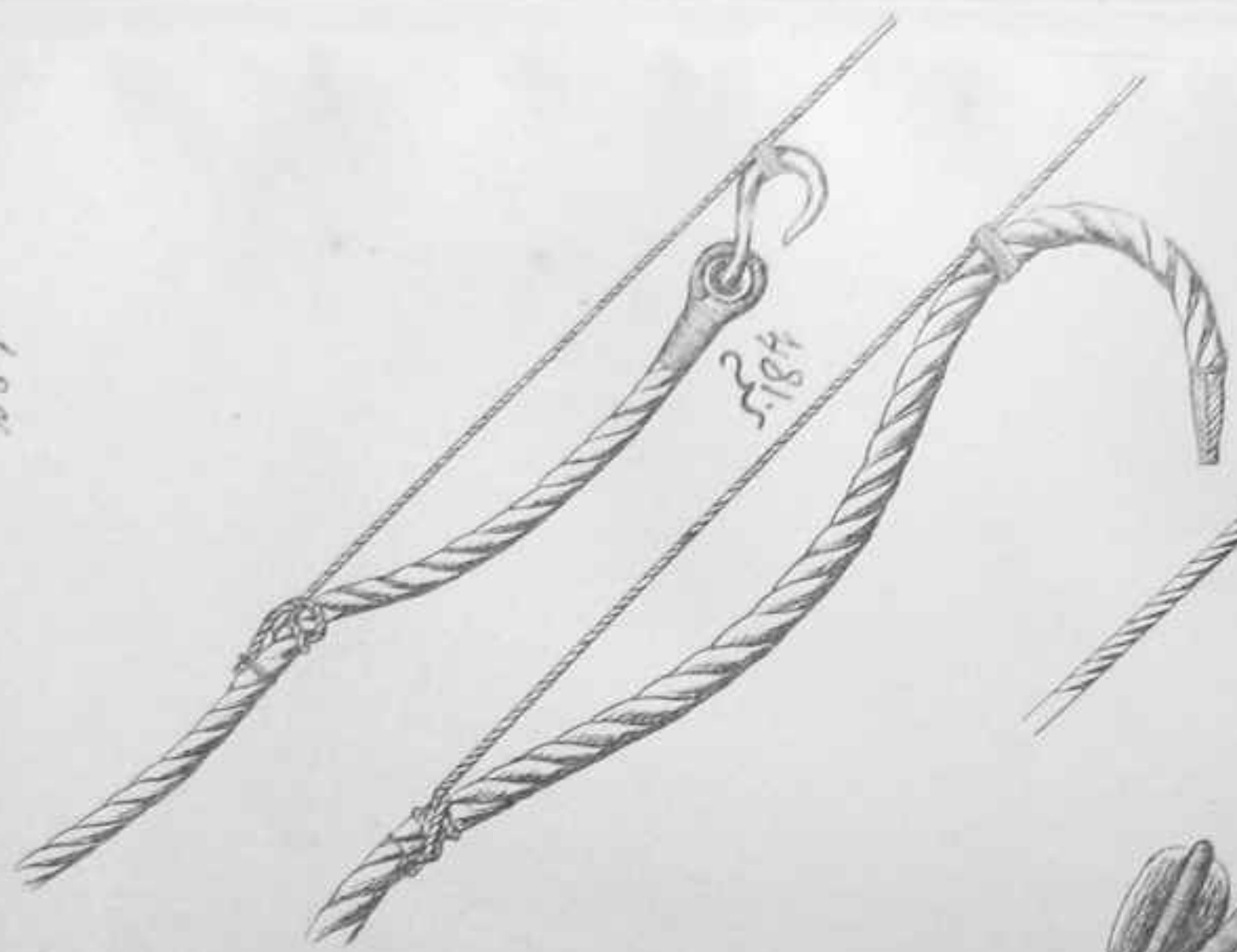

604

Specimen 60

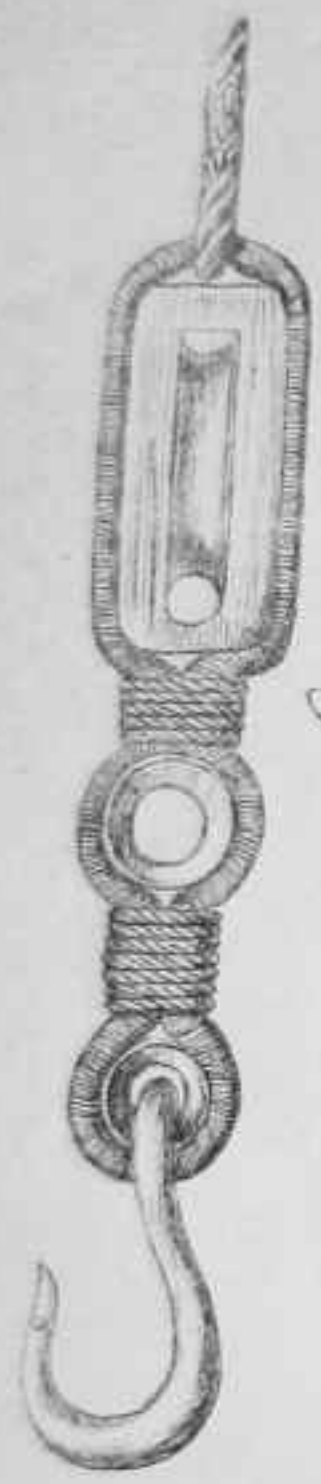

496.

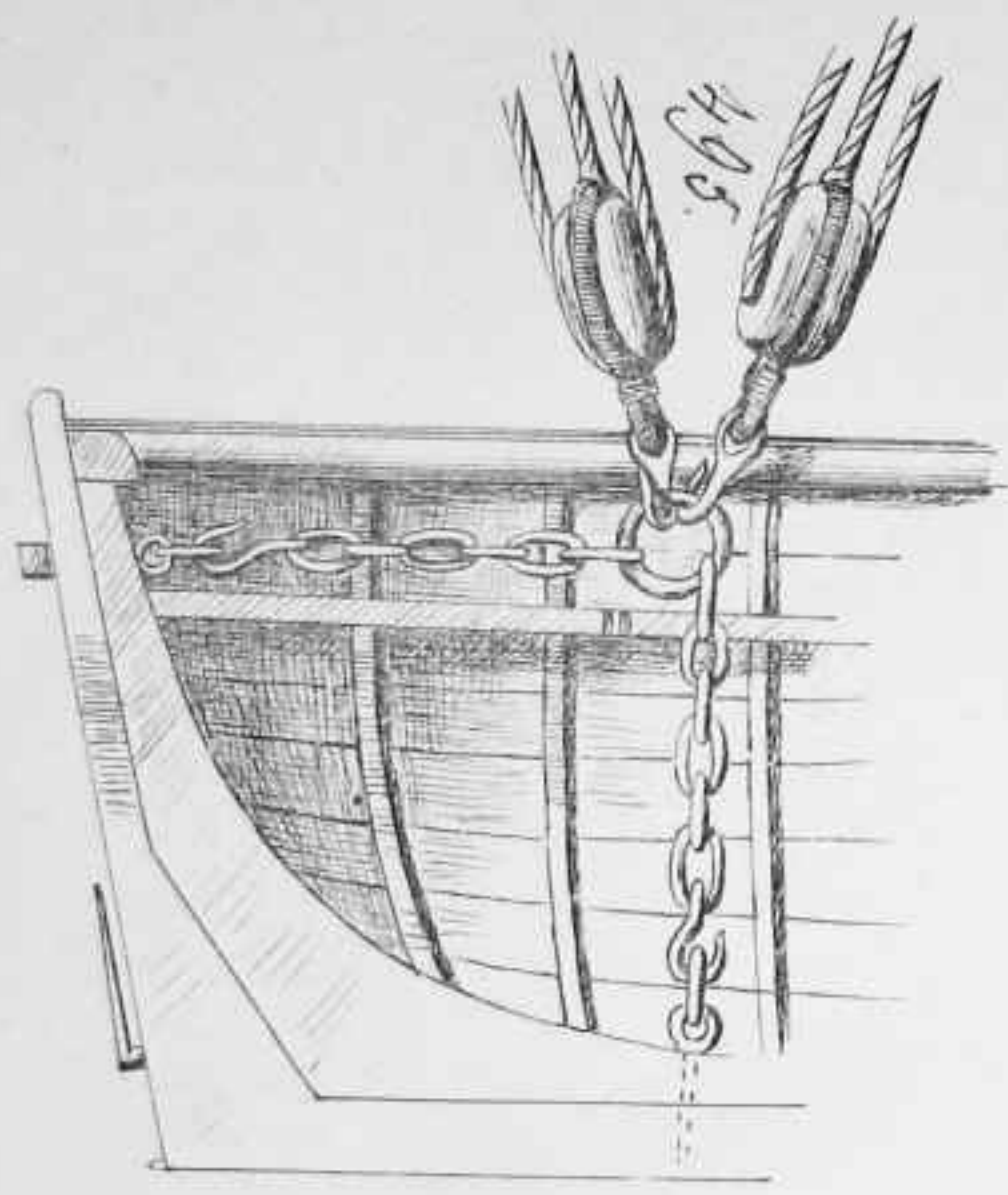

495.

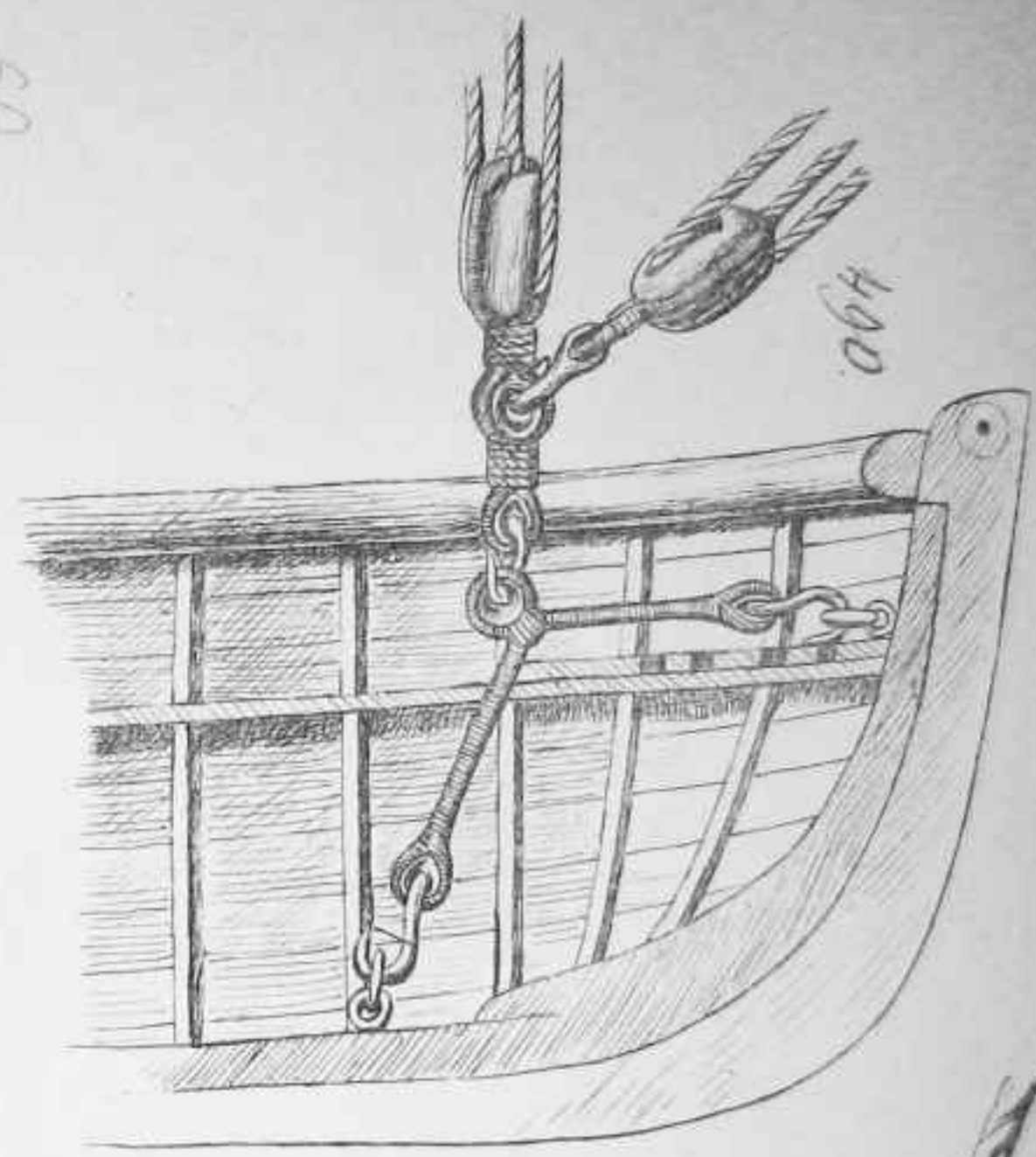

490.



494.



497.

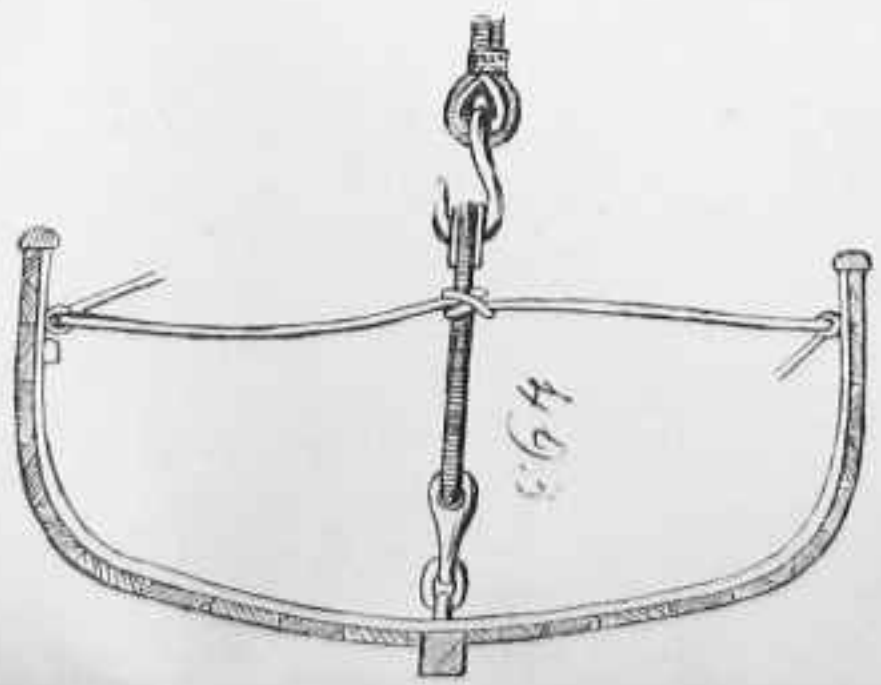

493.



492.



491.

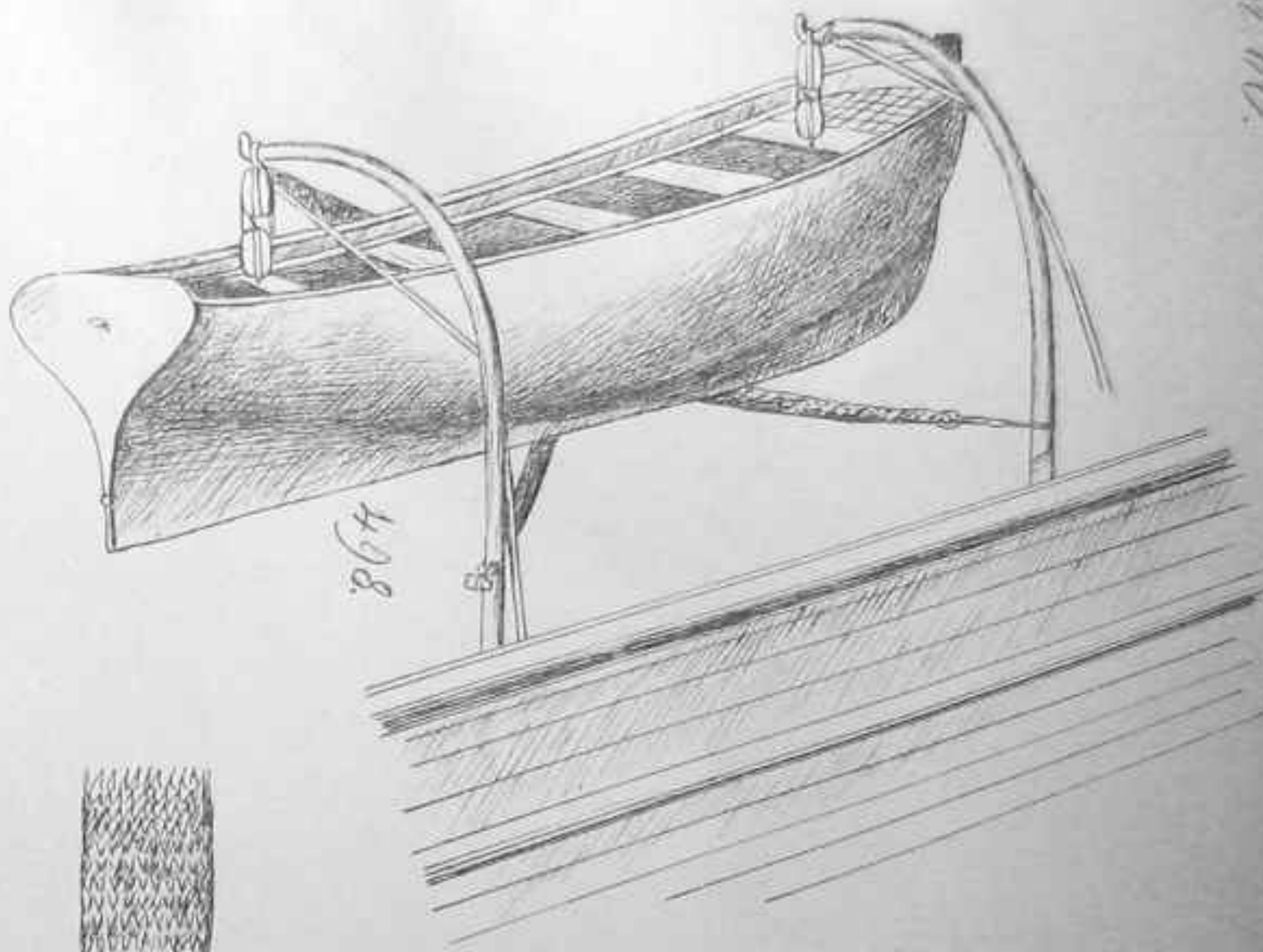

498.

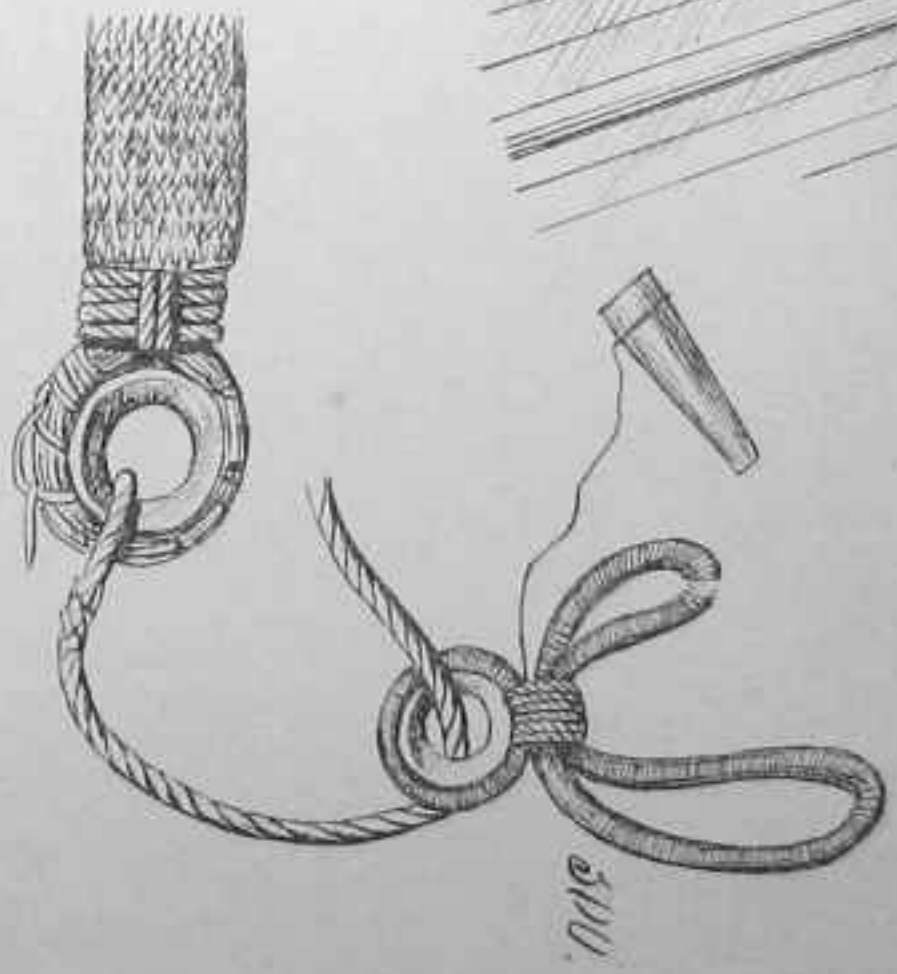

500.



499.

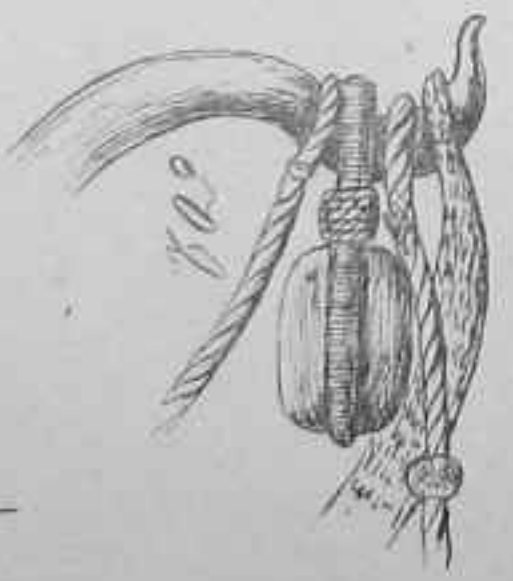

501.

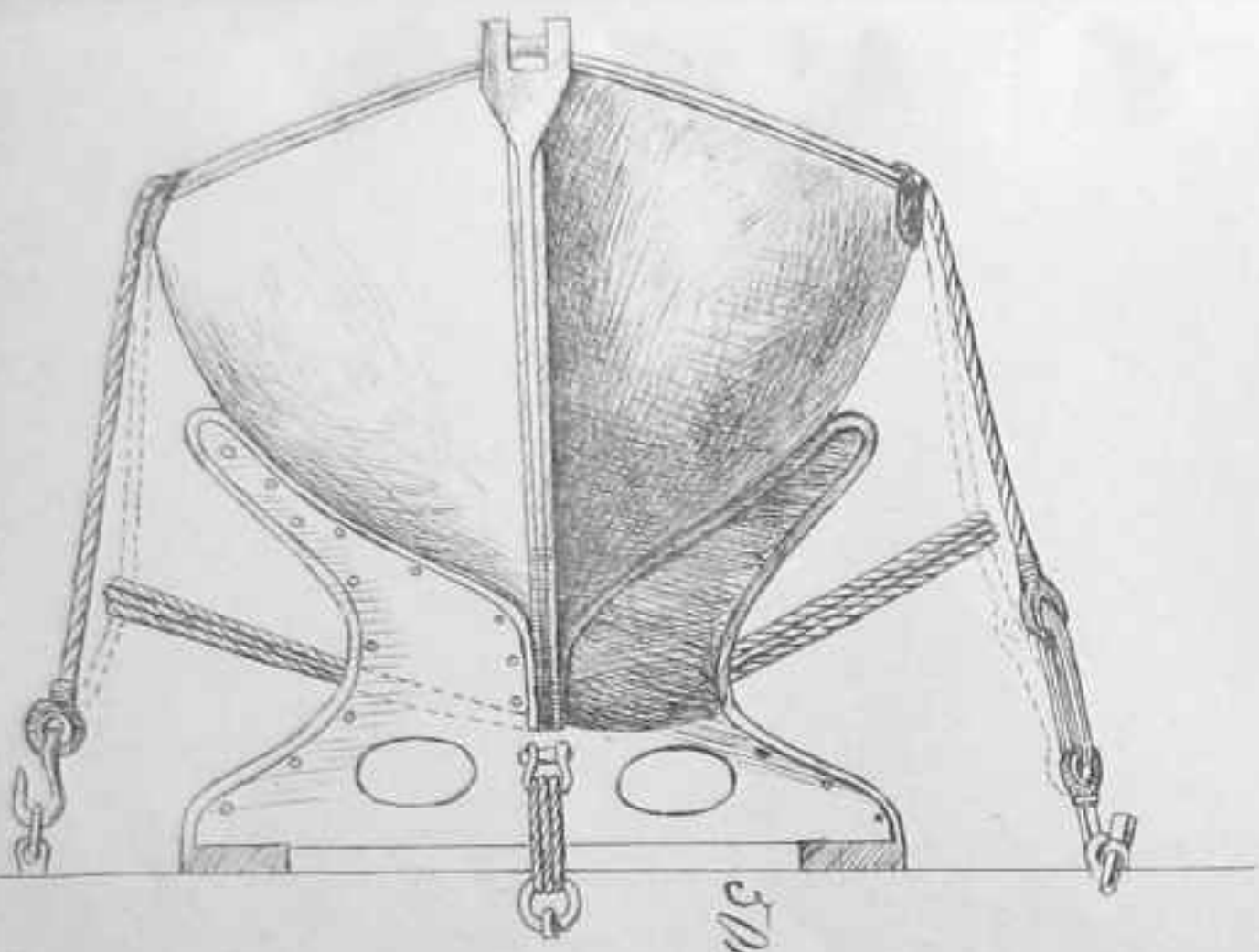

501.

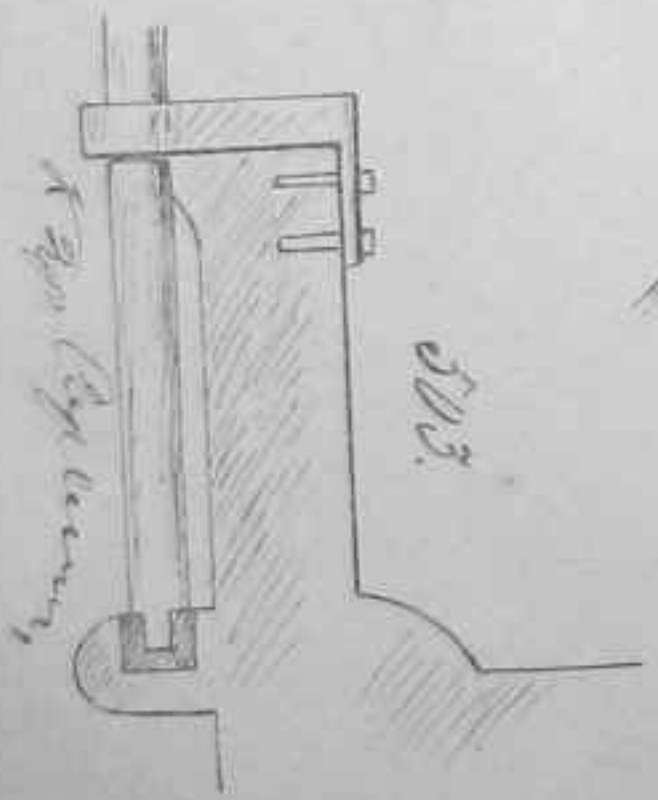

503.

Key (eye beam)

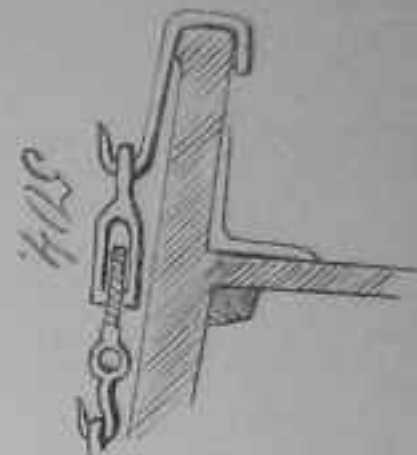
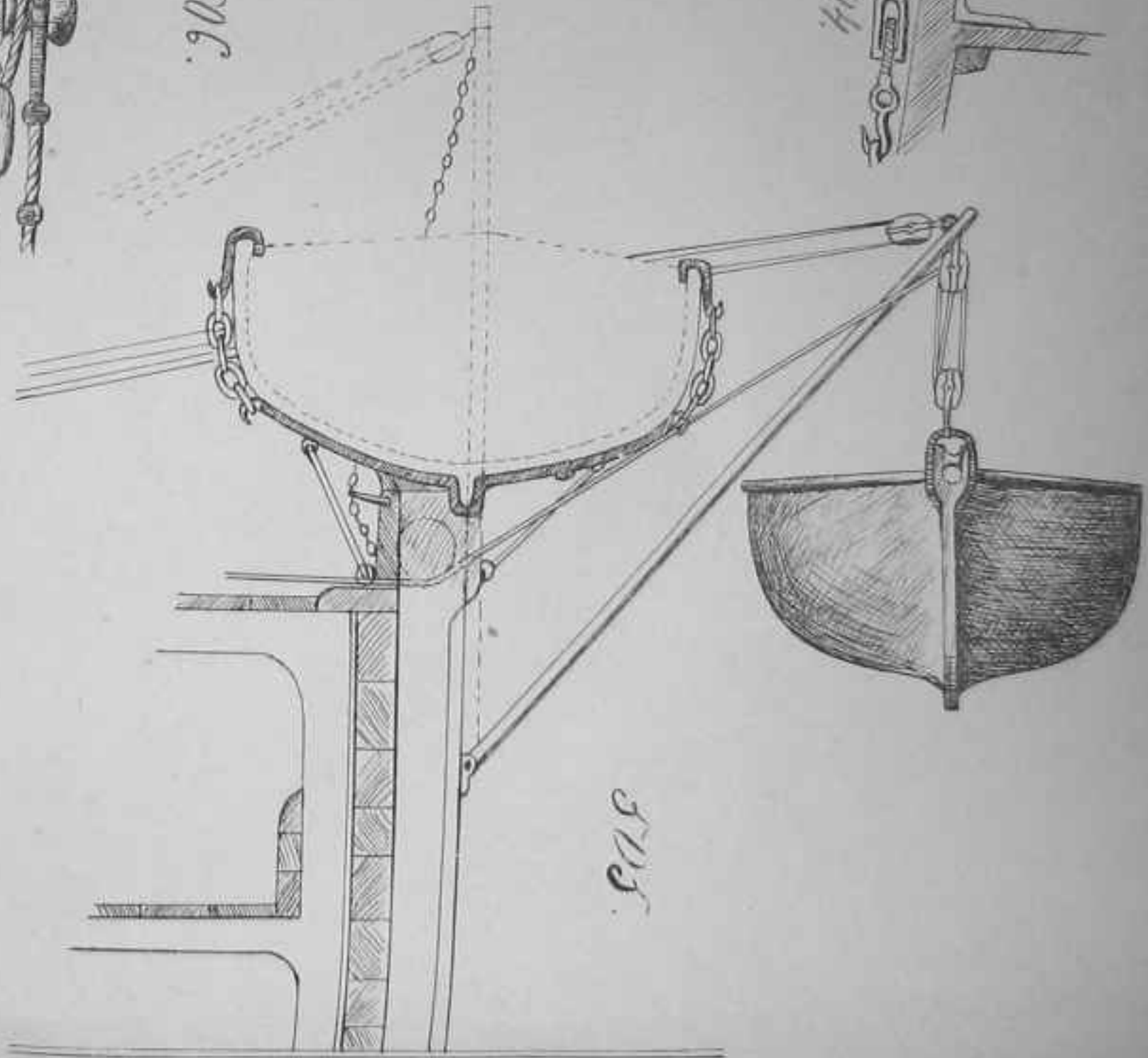
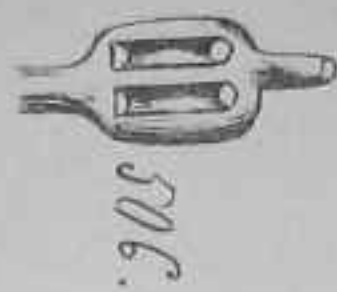
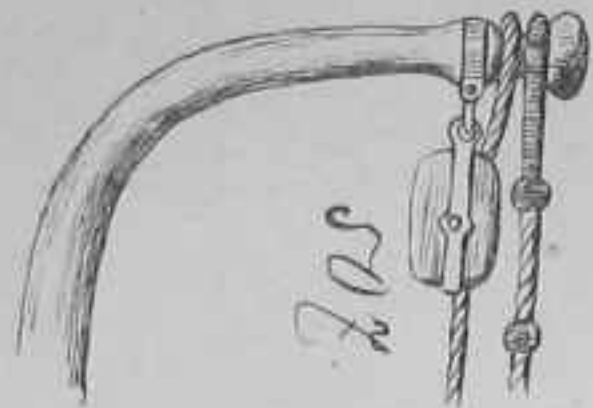
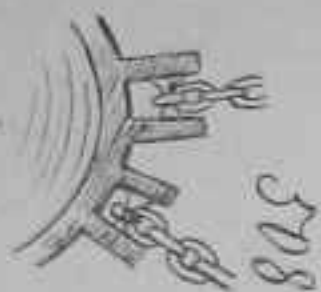
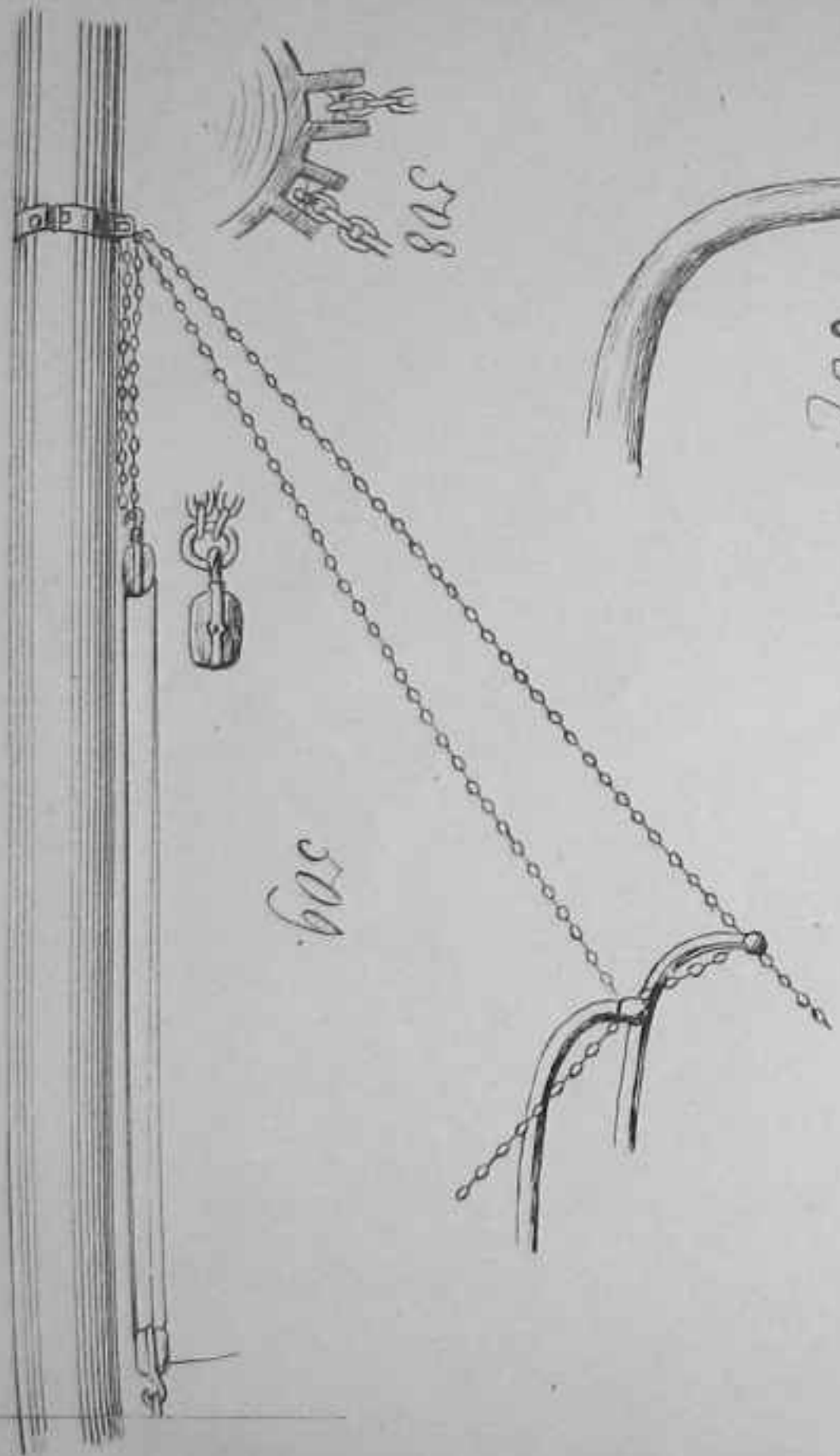

Sturms

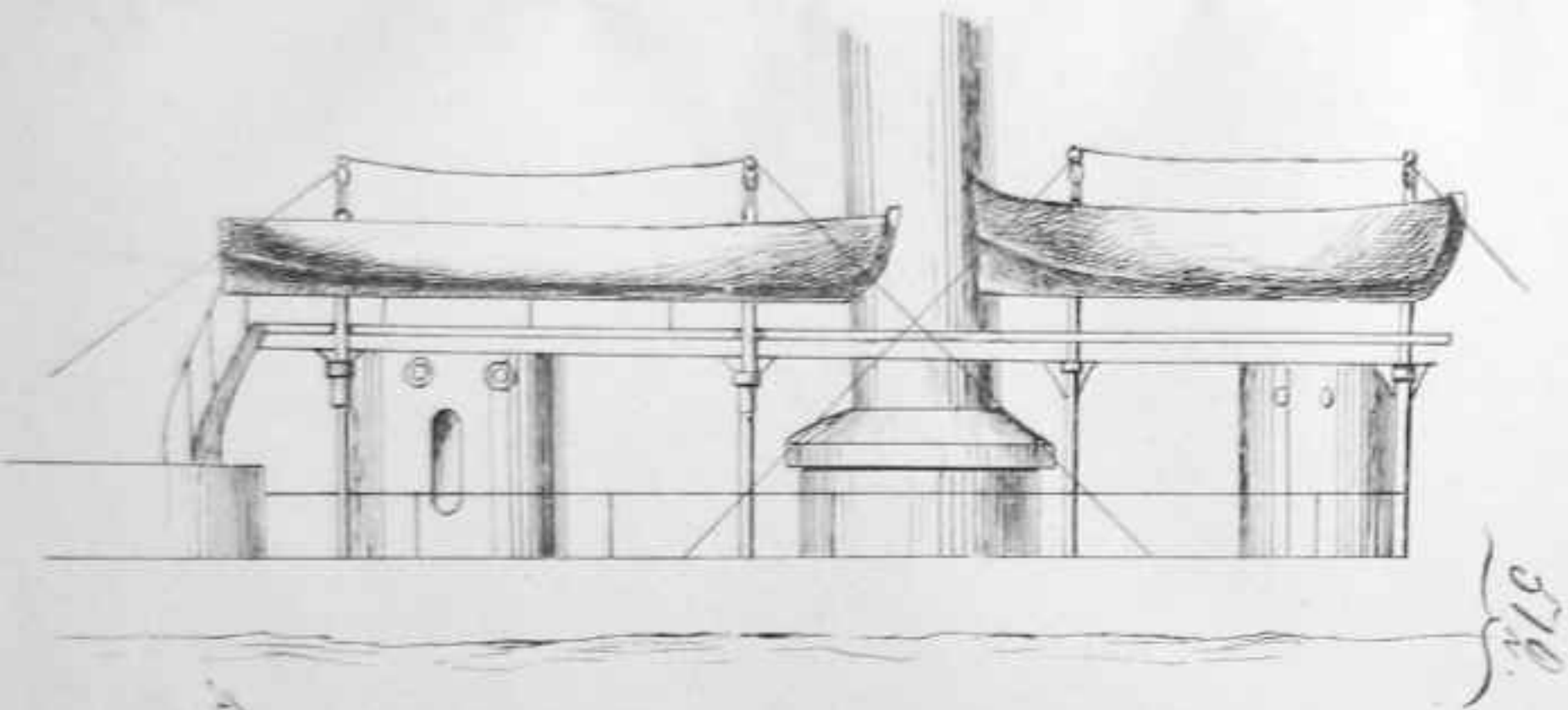

View of the interior

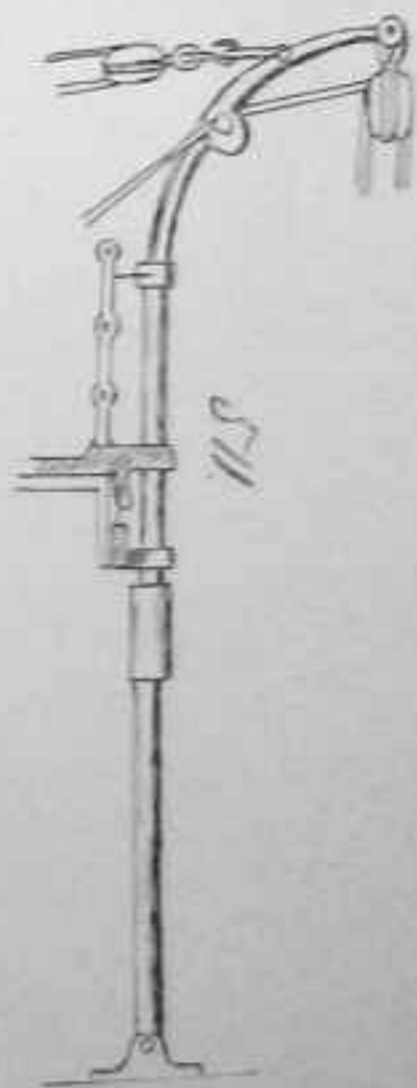
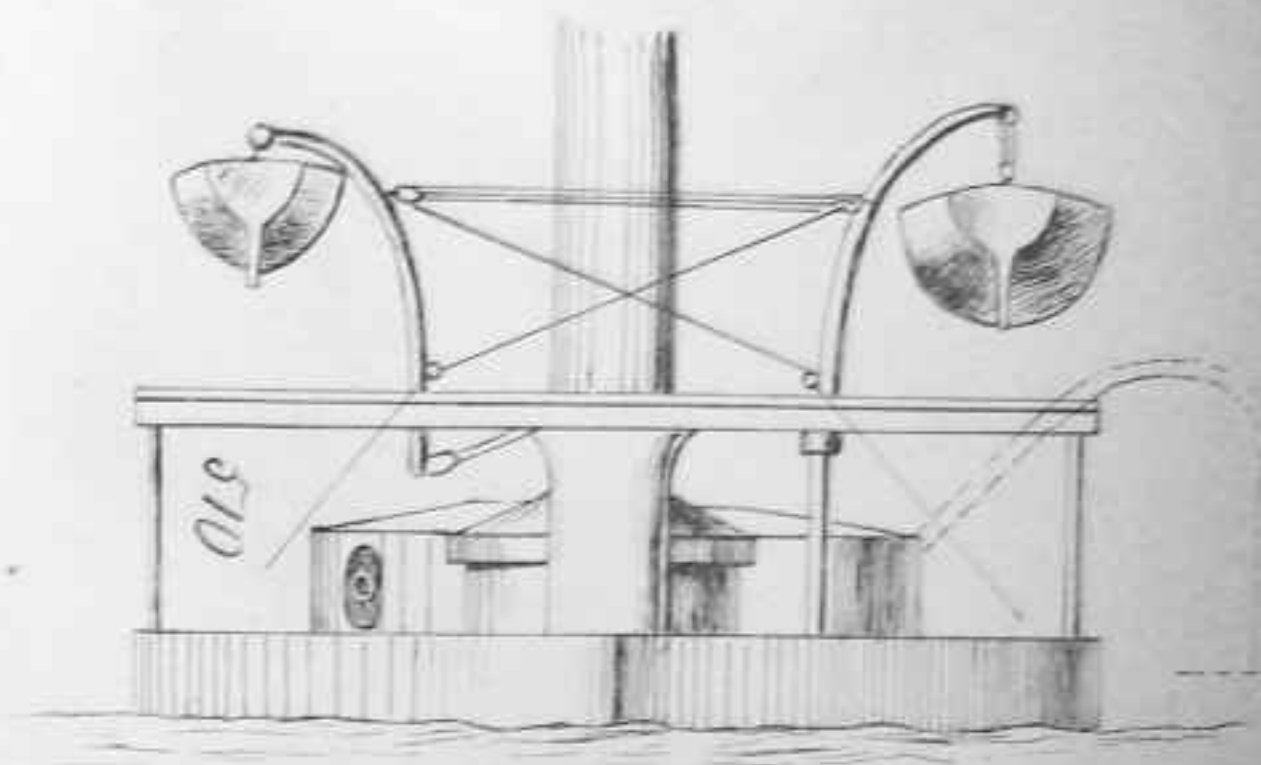
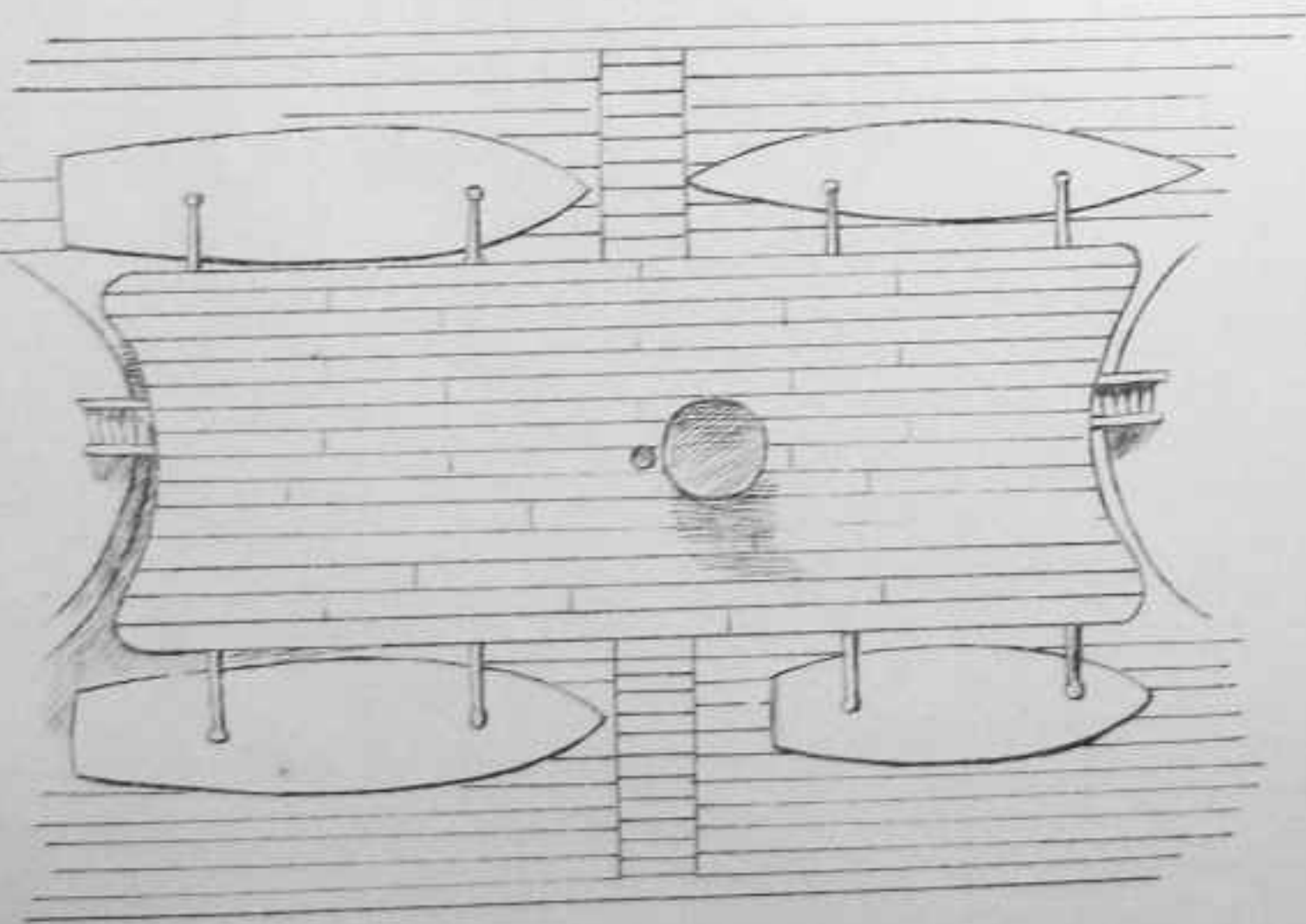

Aug. 62.

513.

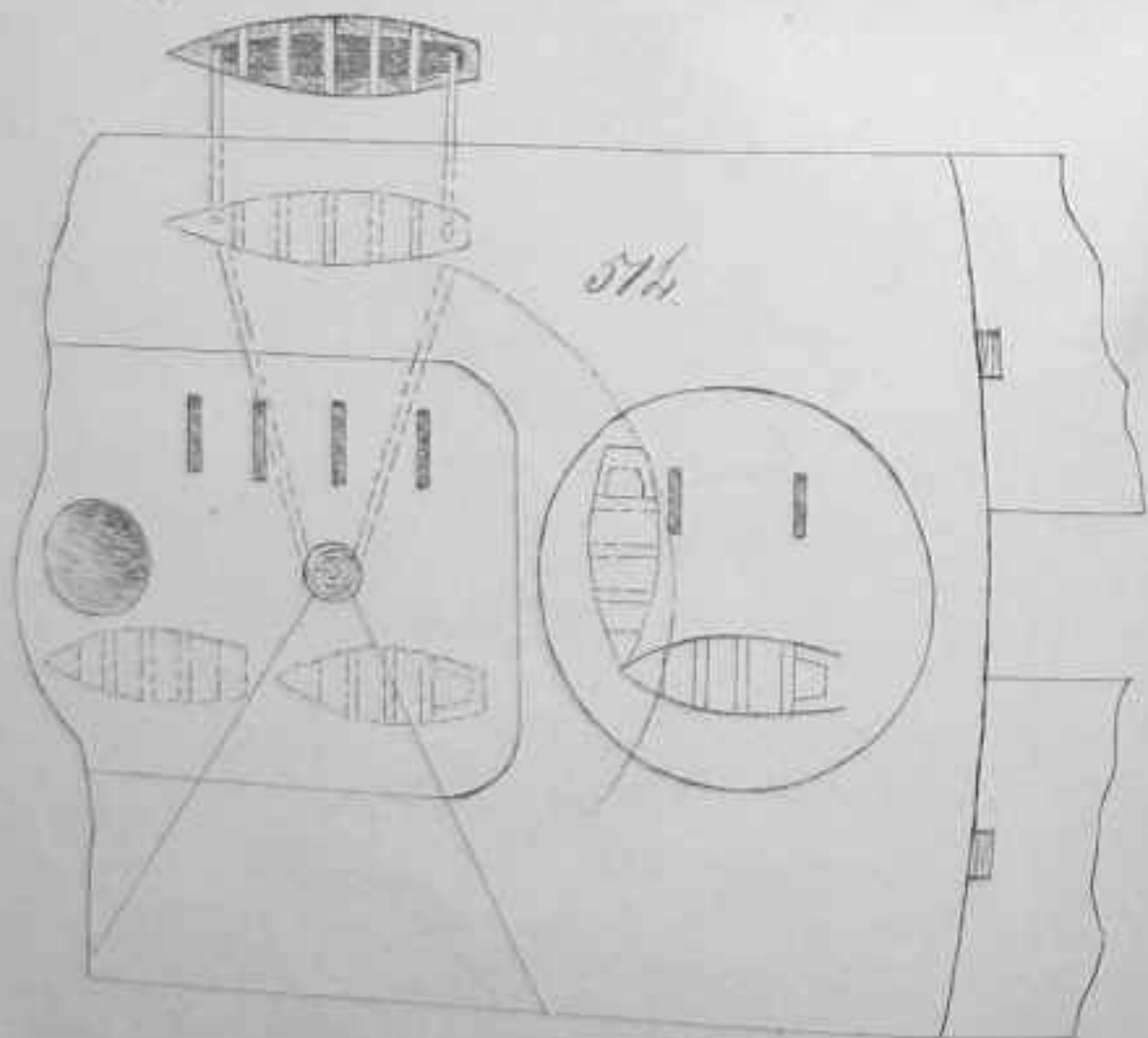
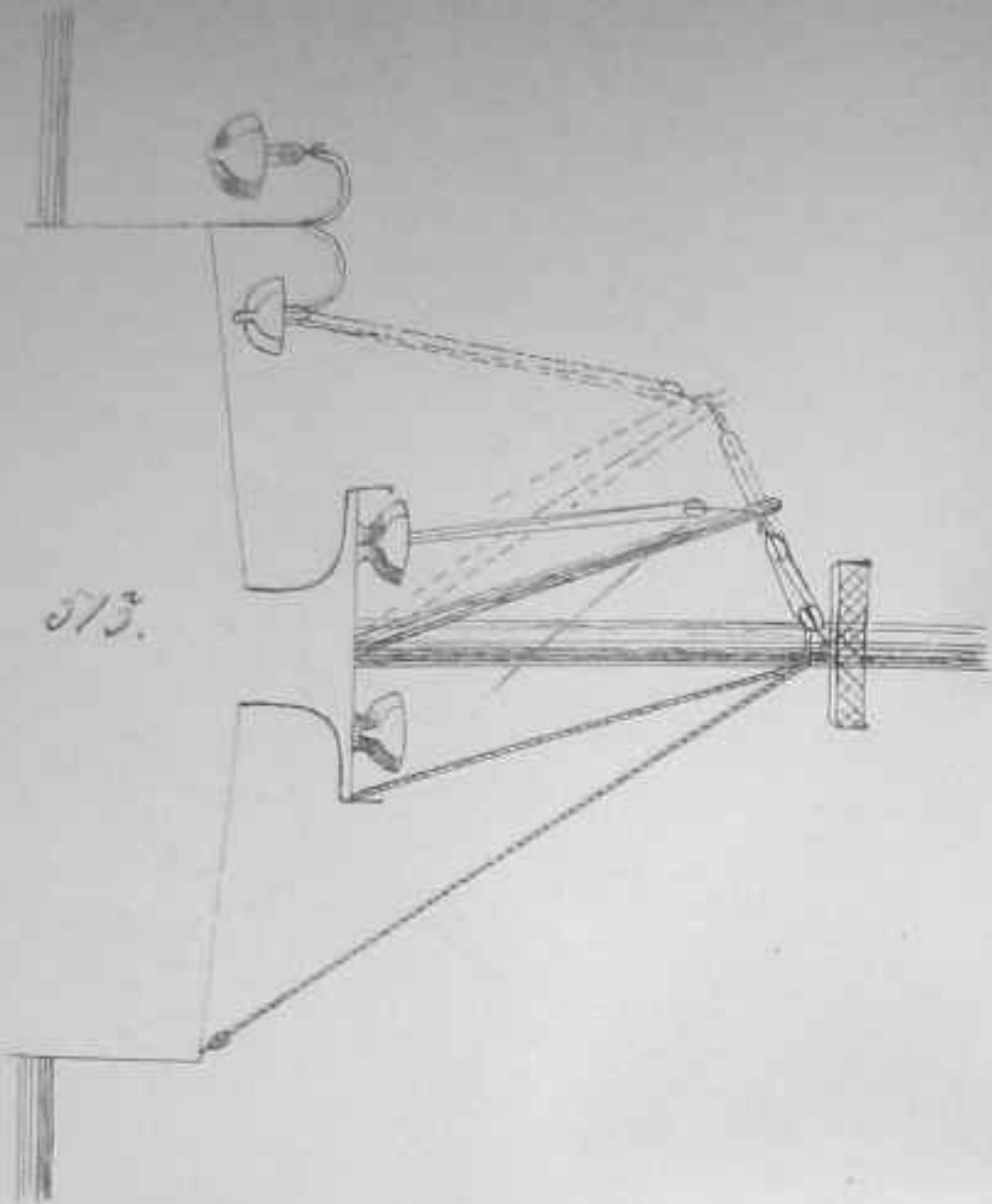

514.

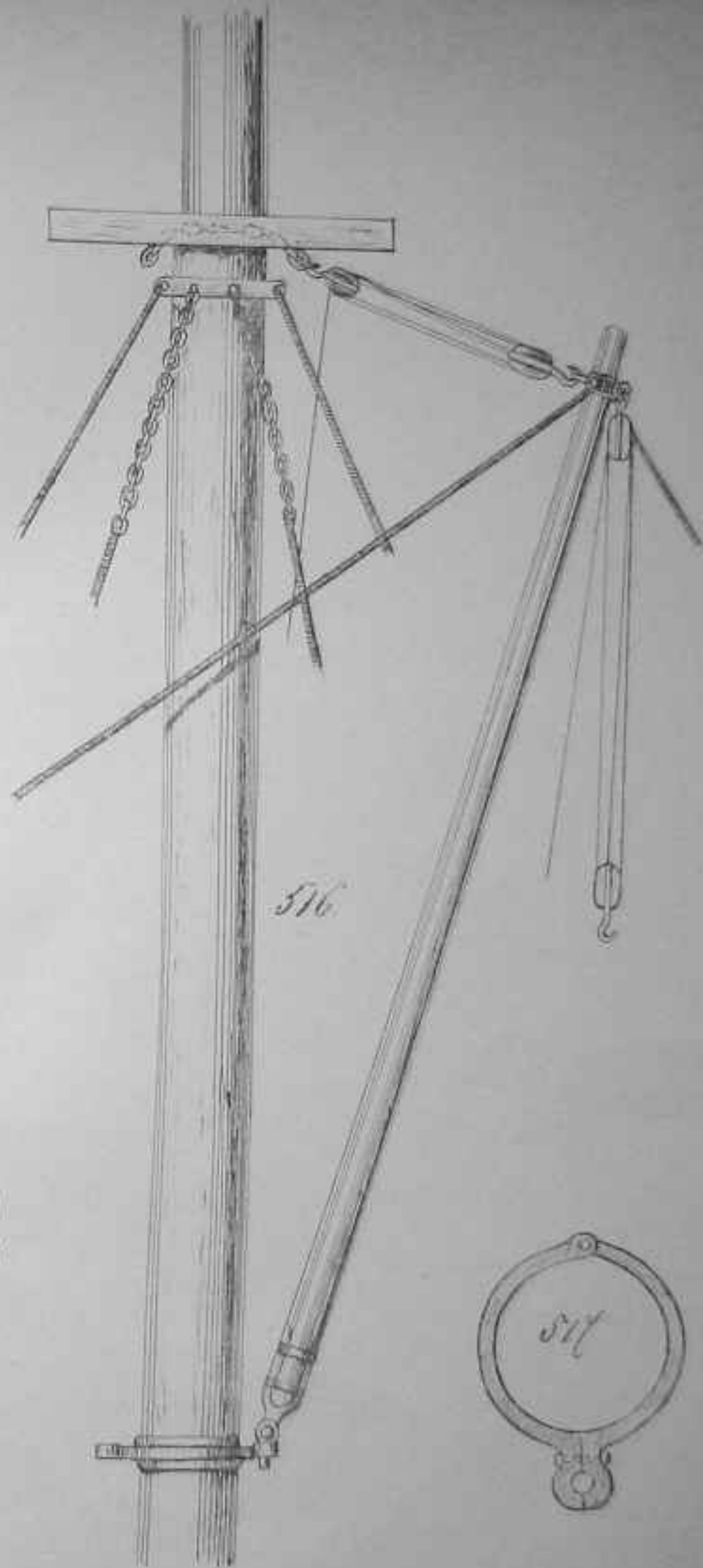

516.



515.



517.

Revised by ...

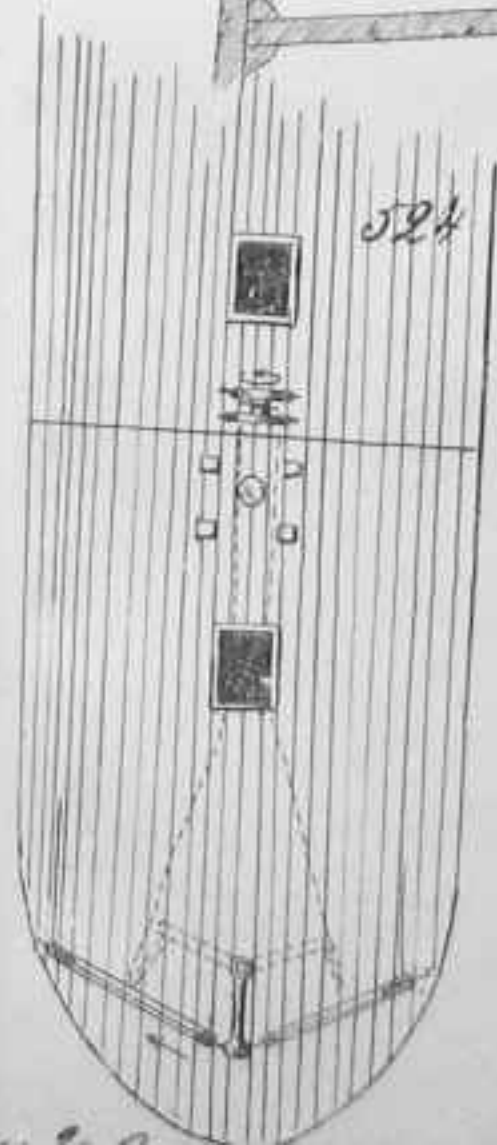
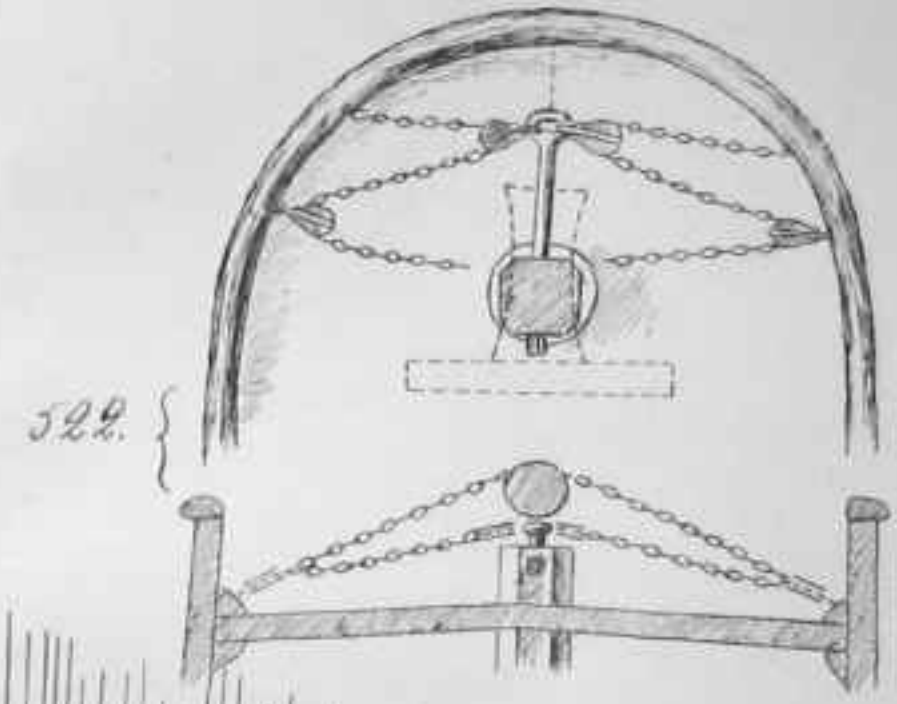
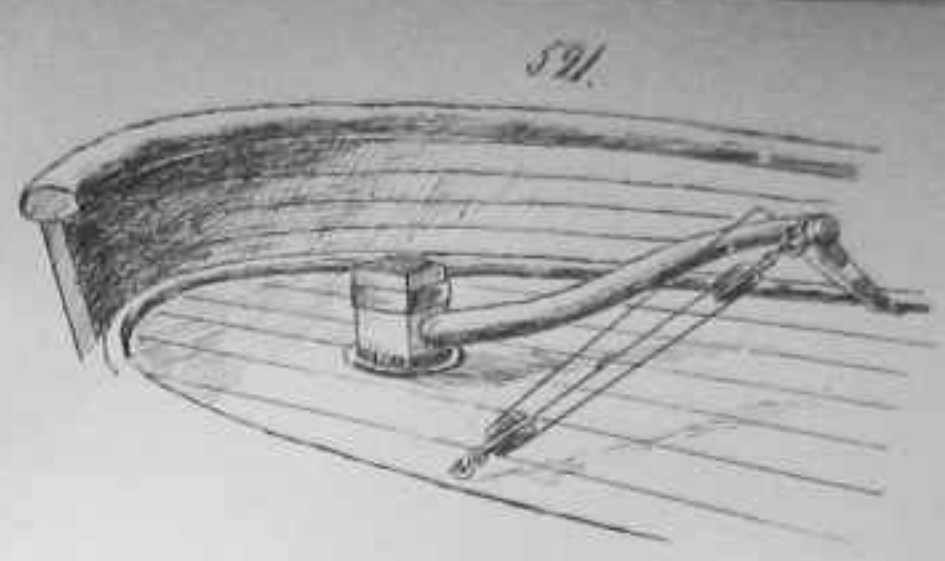
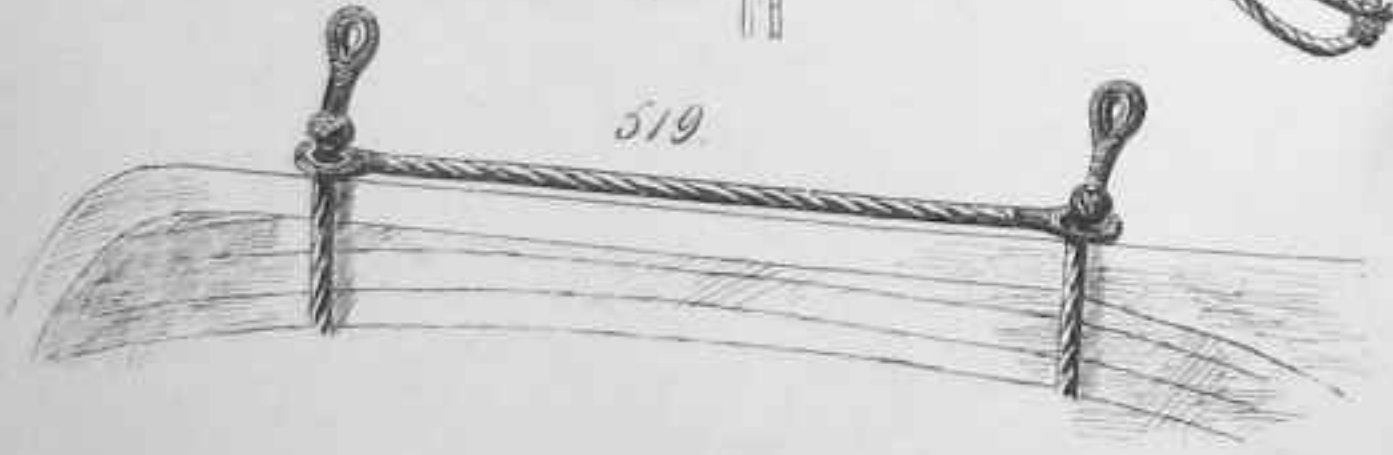
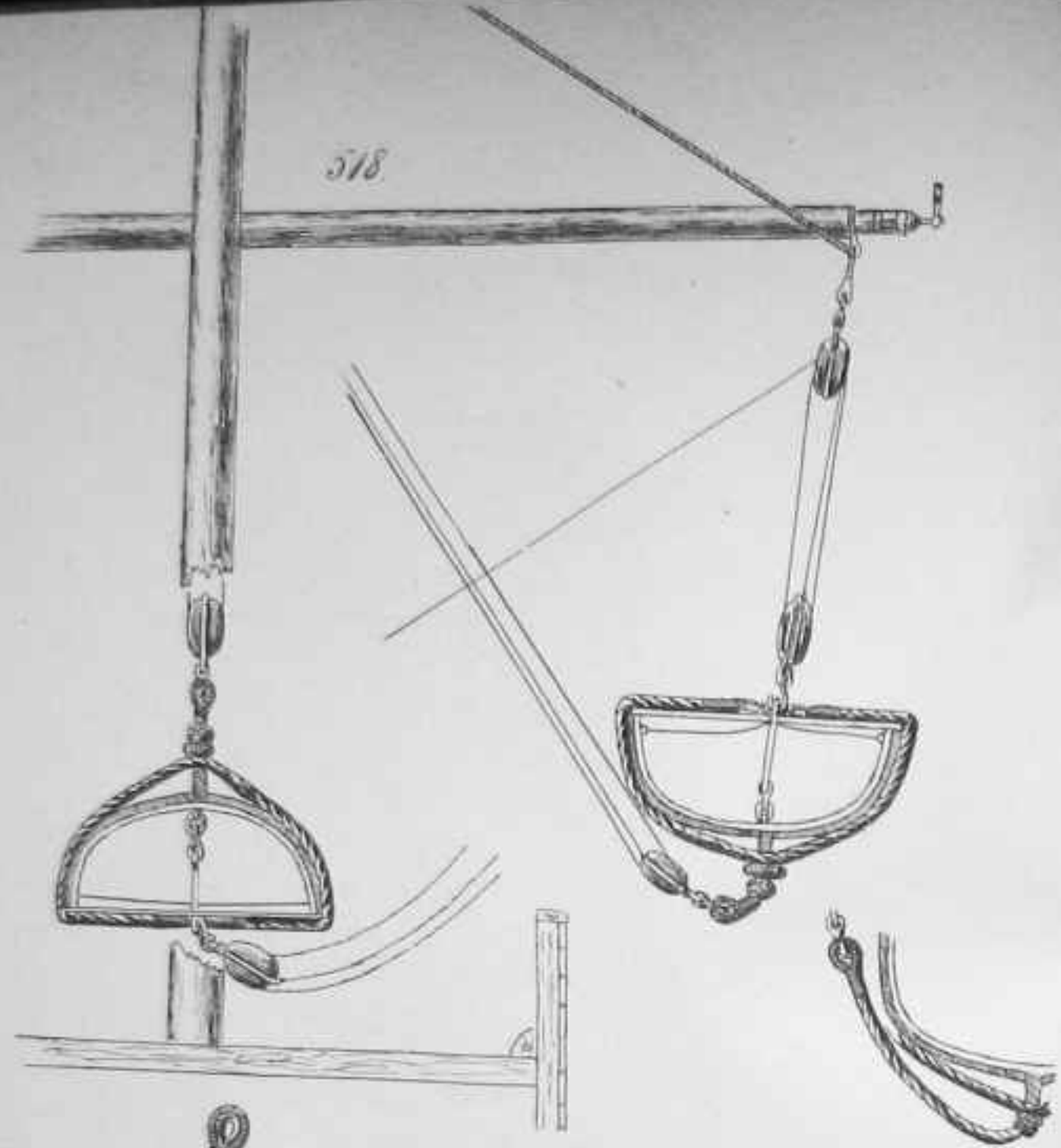

Aug 64



527



530



529

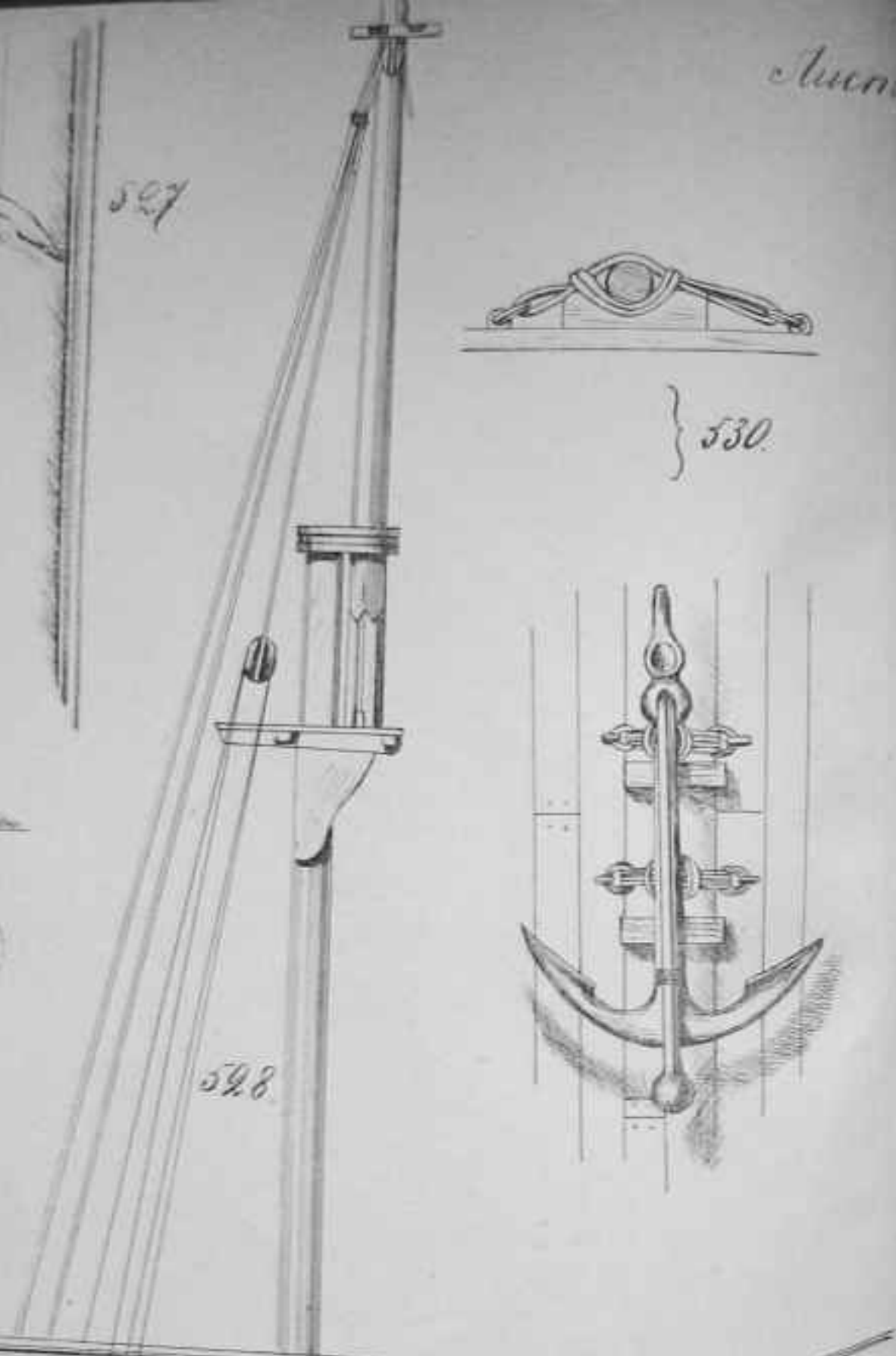

528

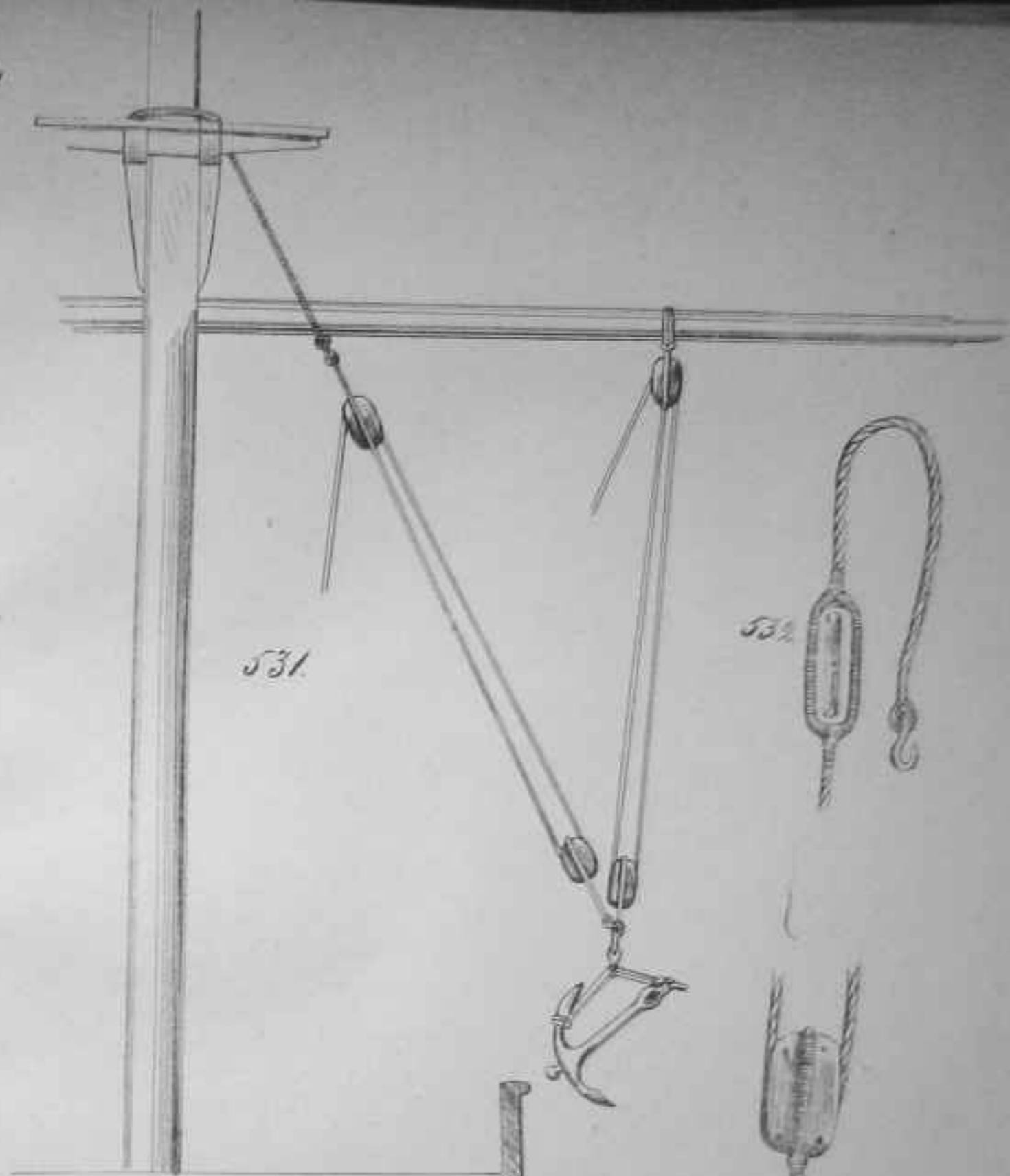
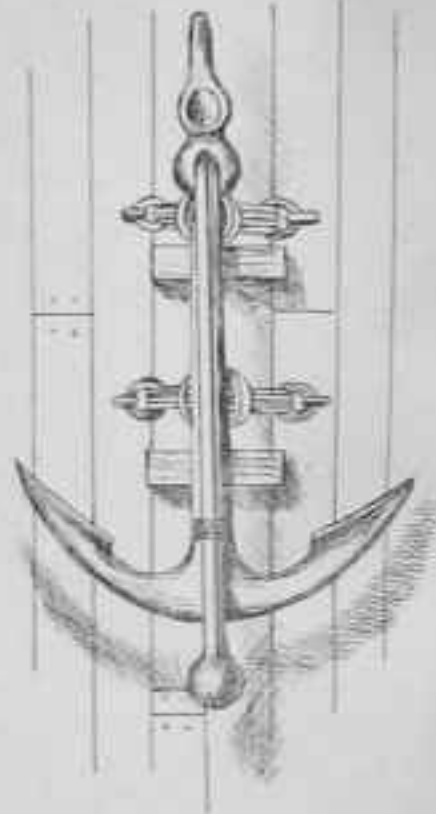

531

532

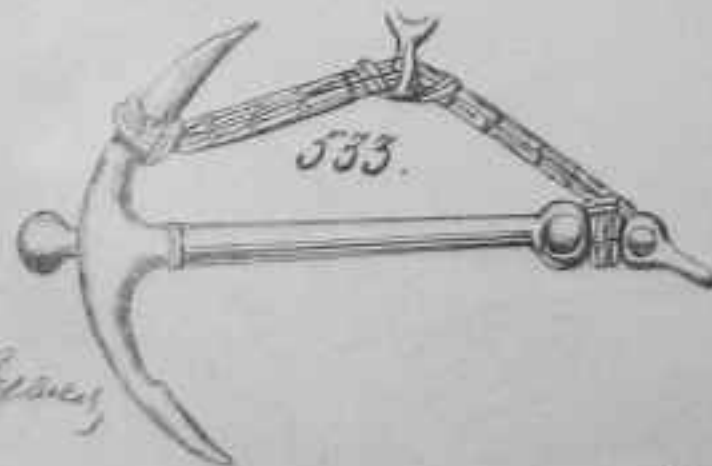

533

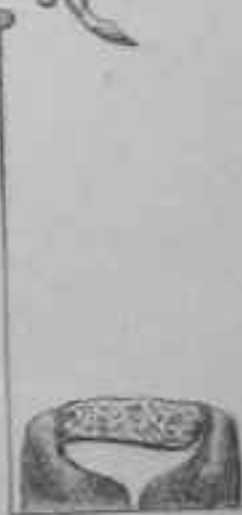

534



can de l'apareil

Lucas 65.

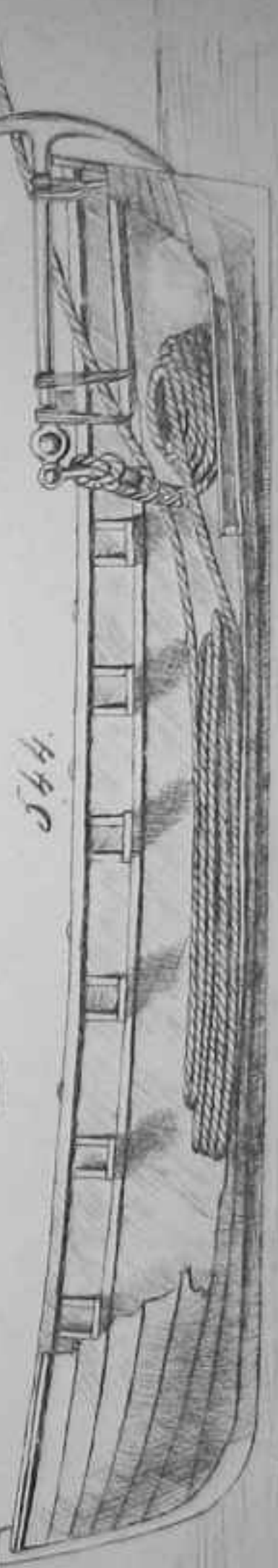
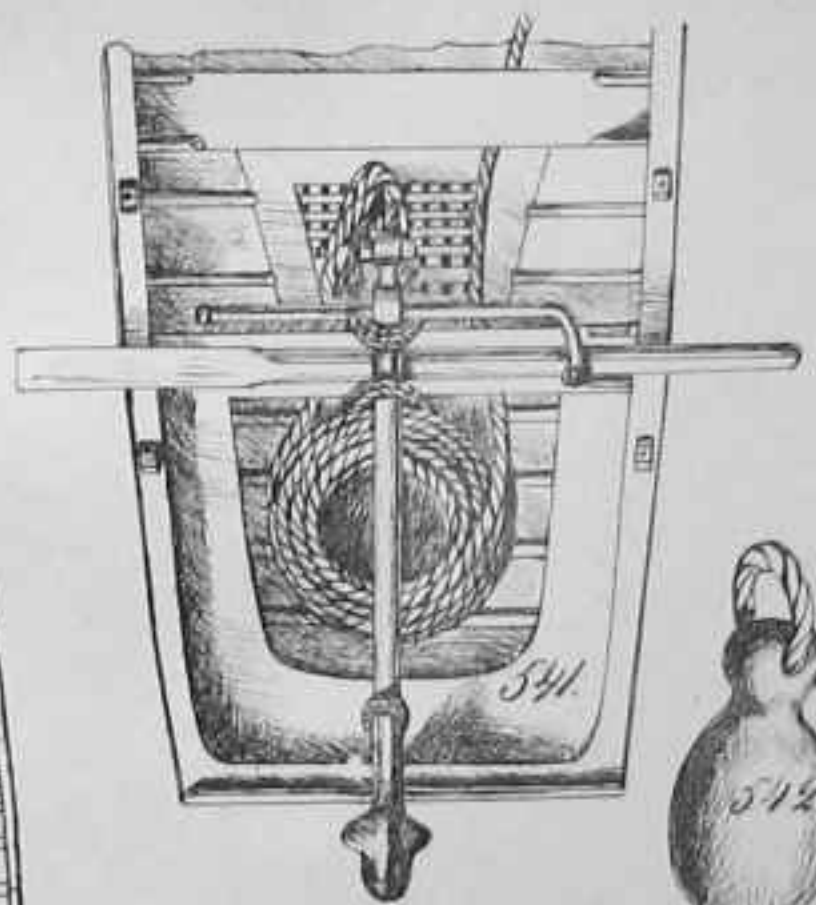
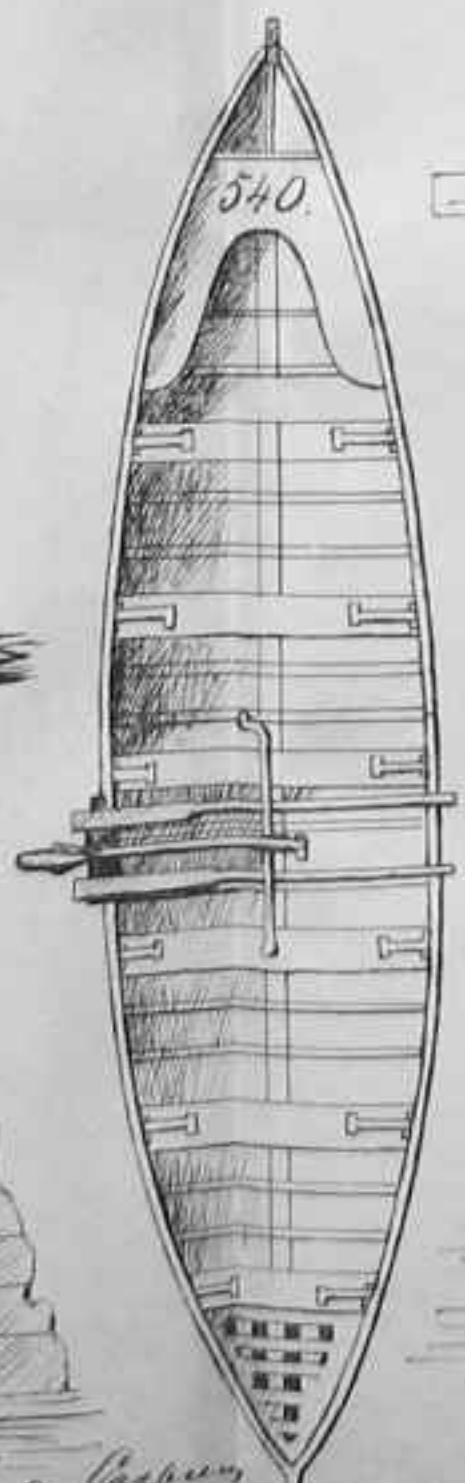
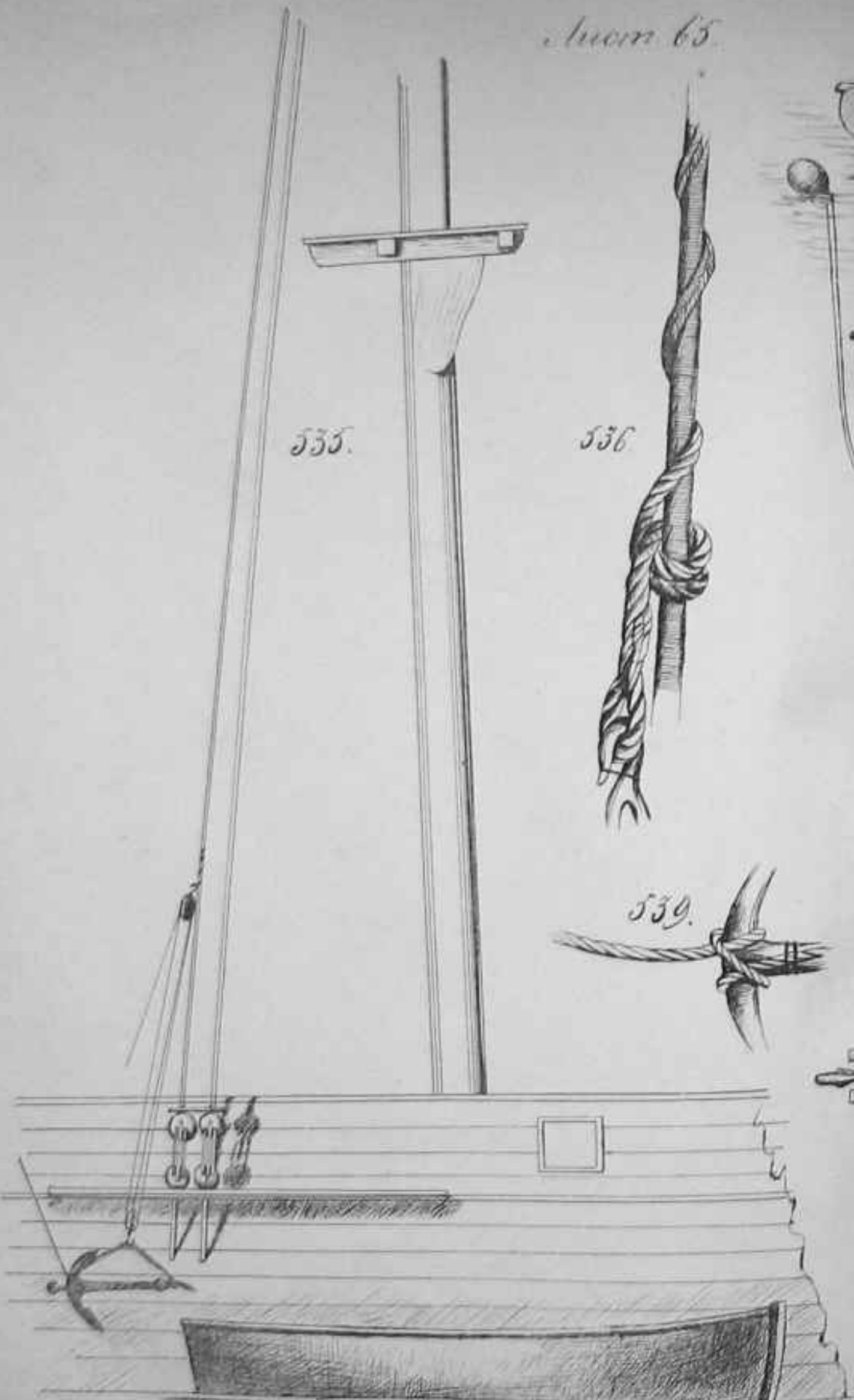

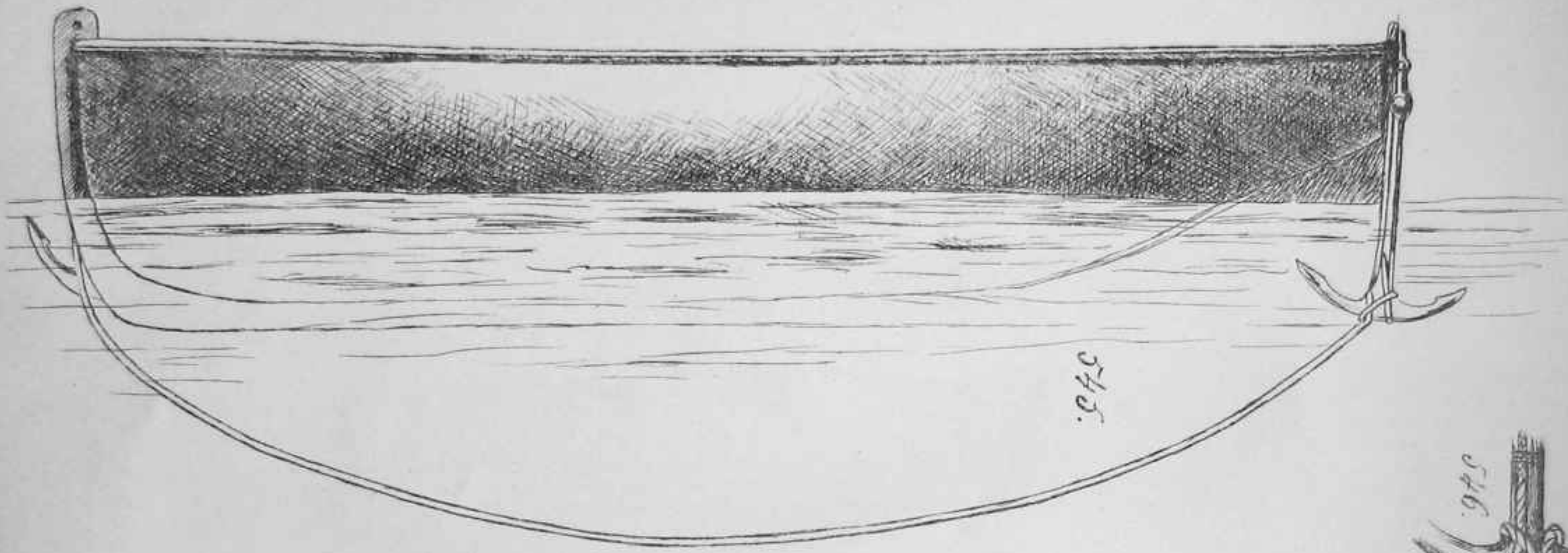

545.



546.

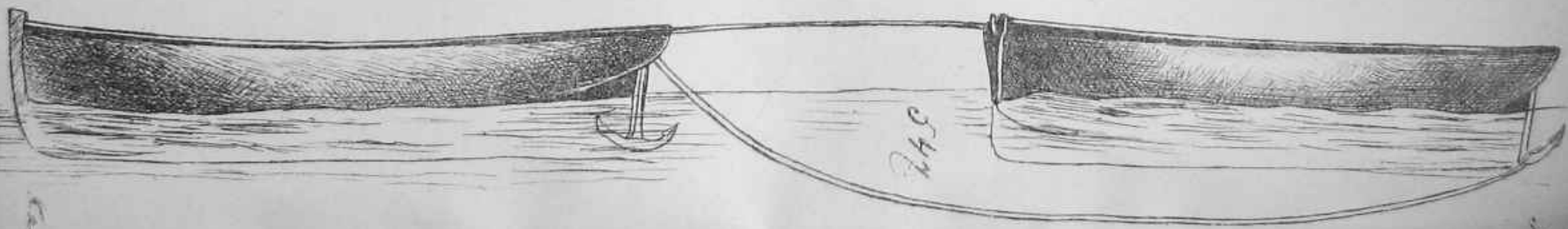

548

Capitain

Page 66



548

550.



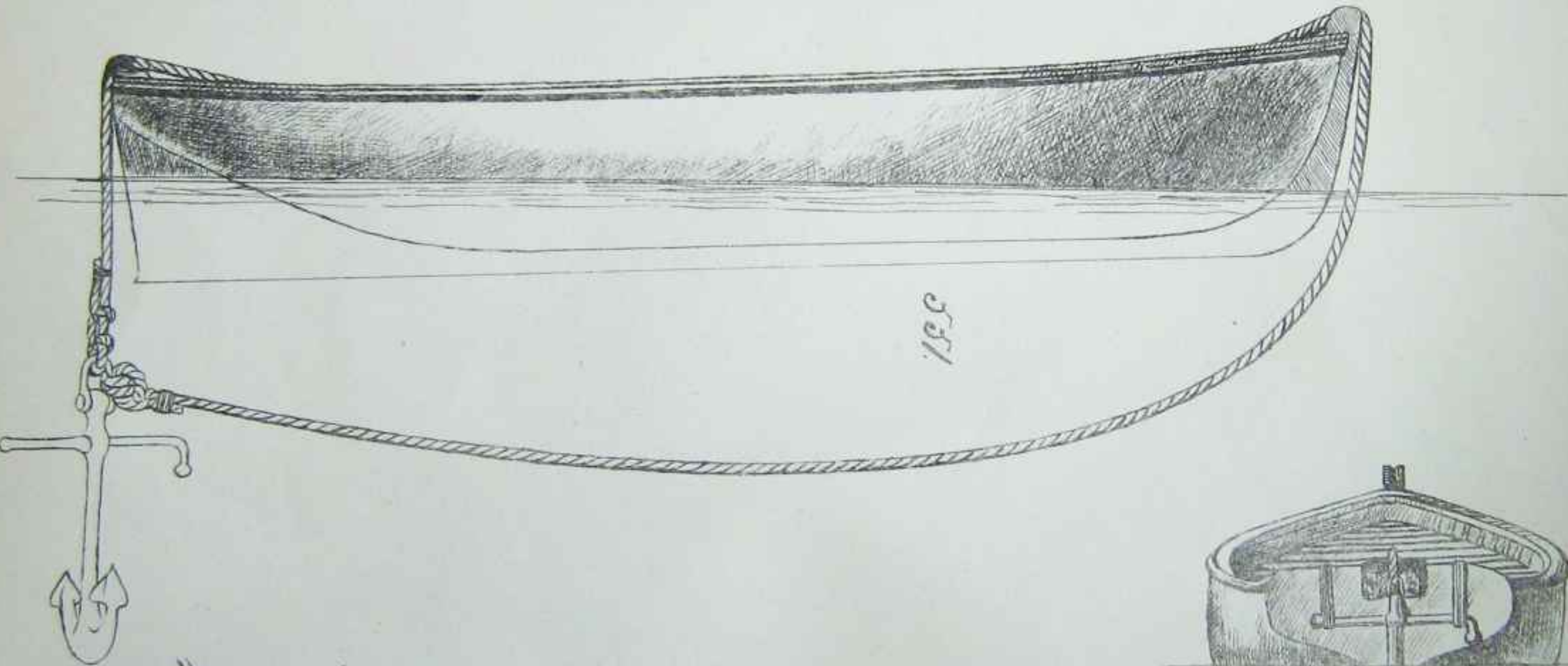

Row Boat

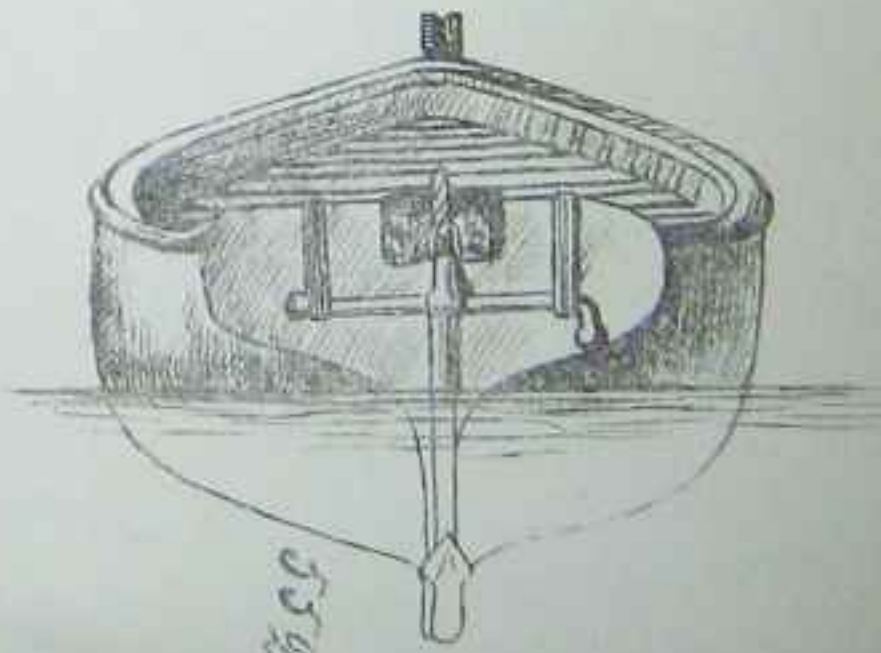

Row Boat

555

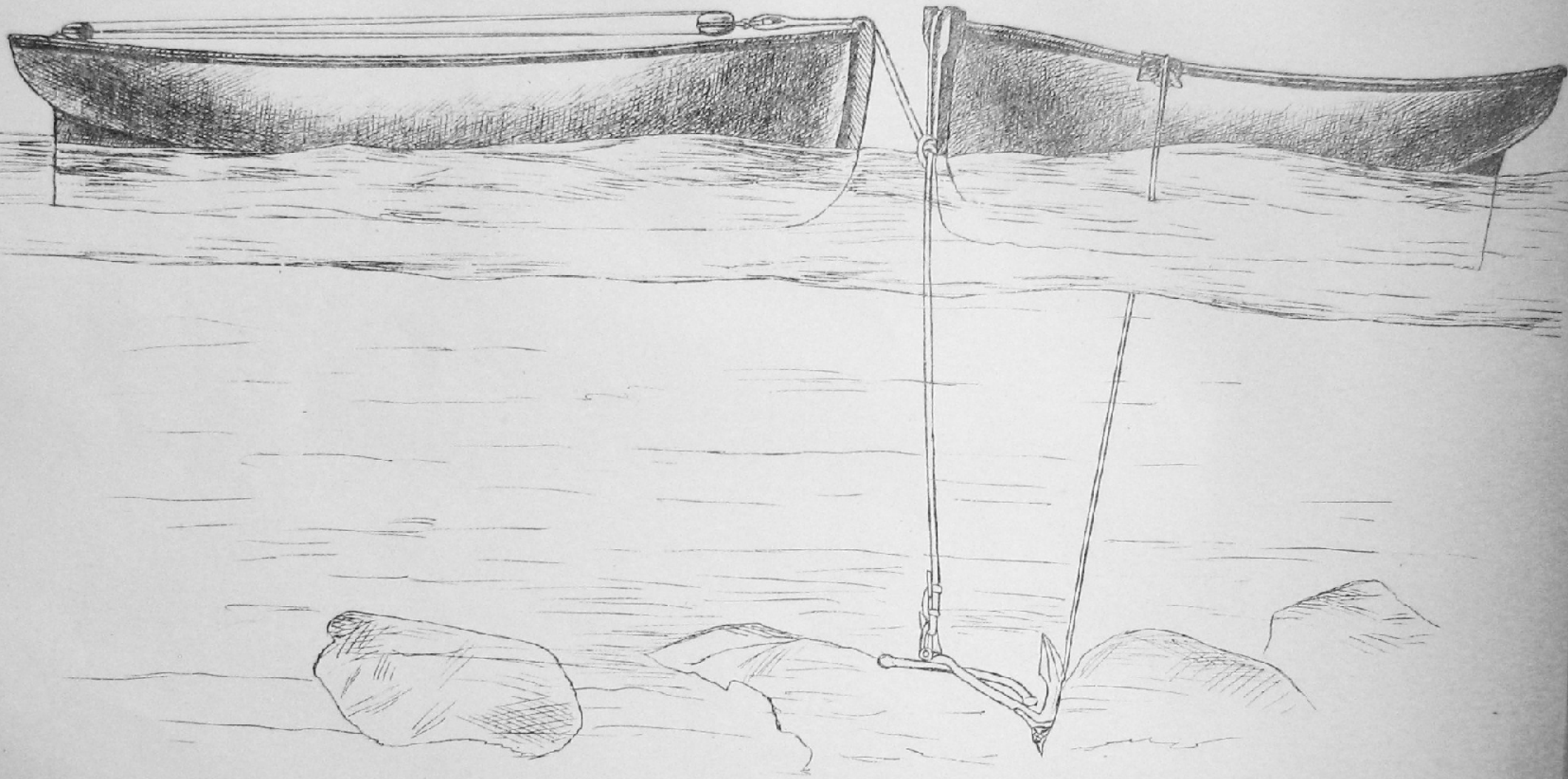



554.

Swanwick

1861

50 Captains

18

555

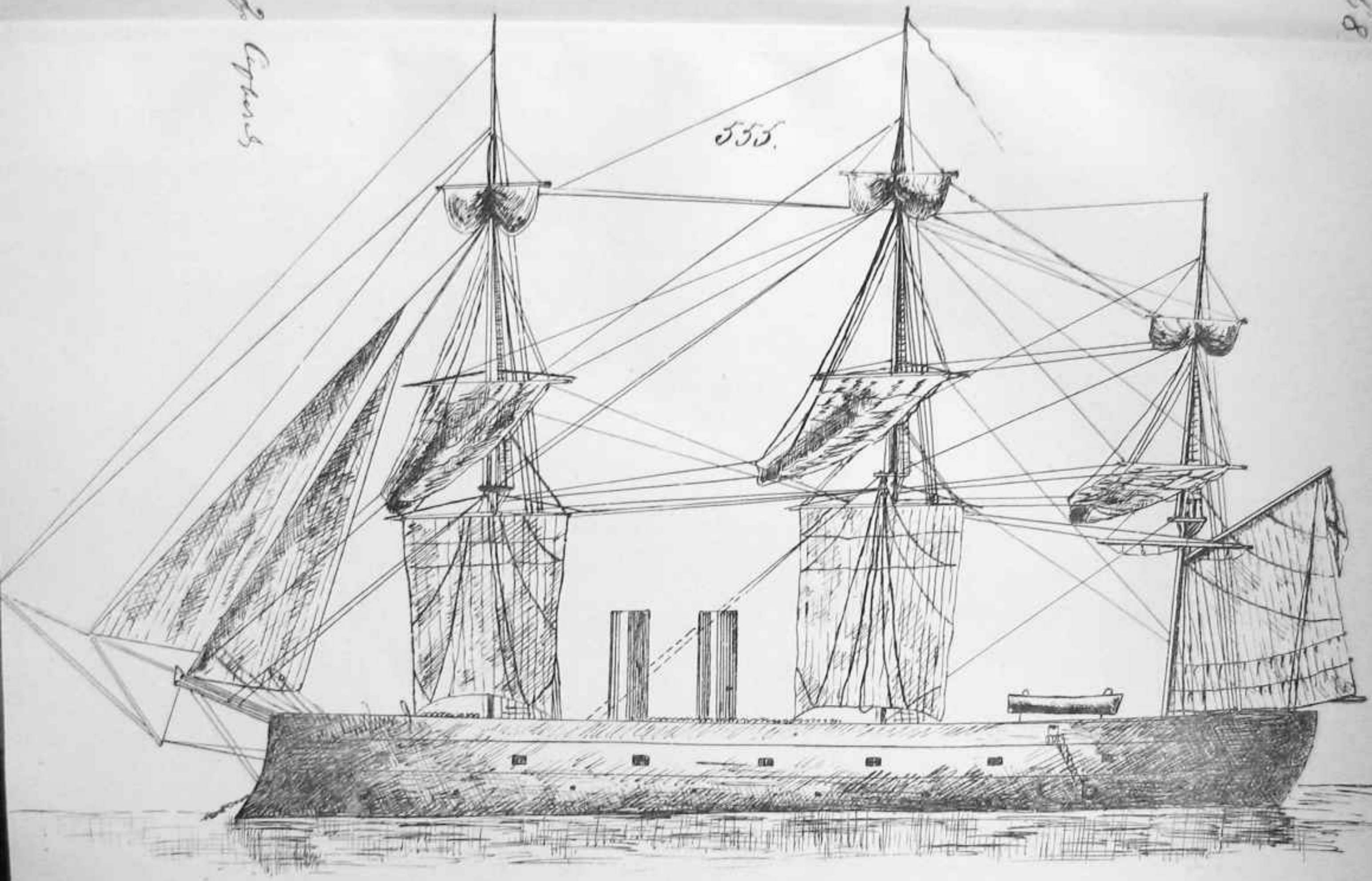

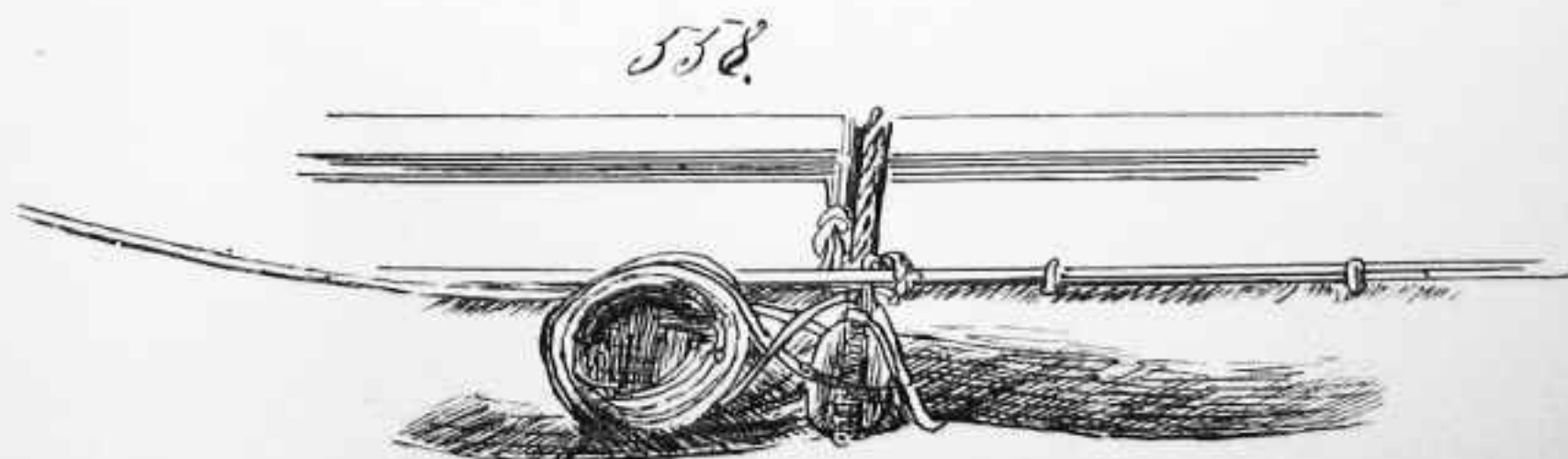
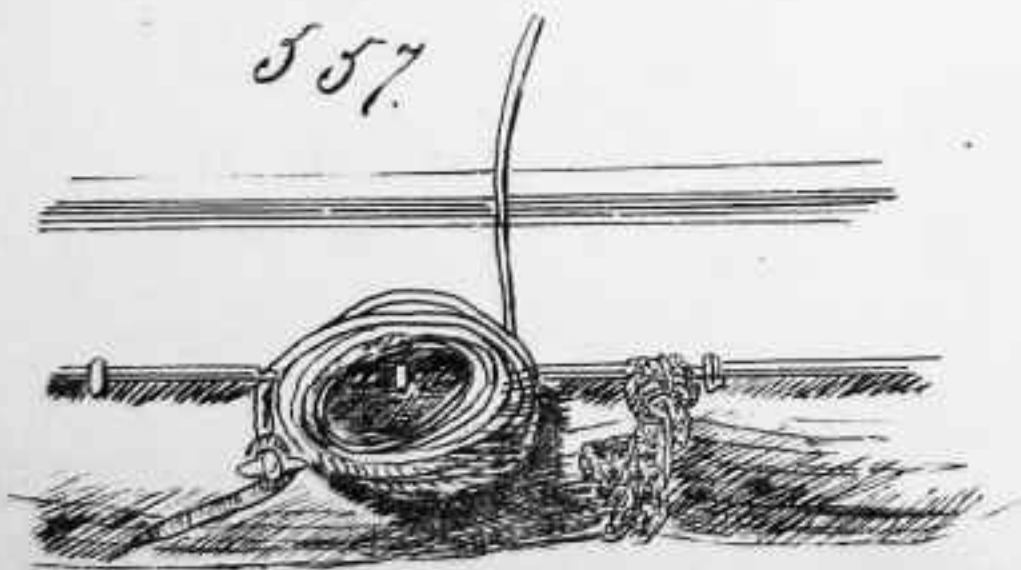
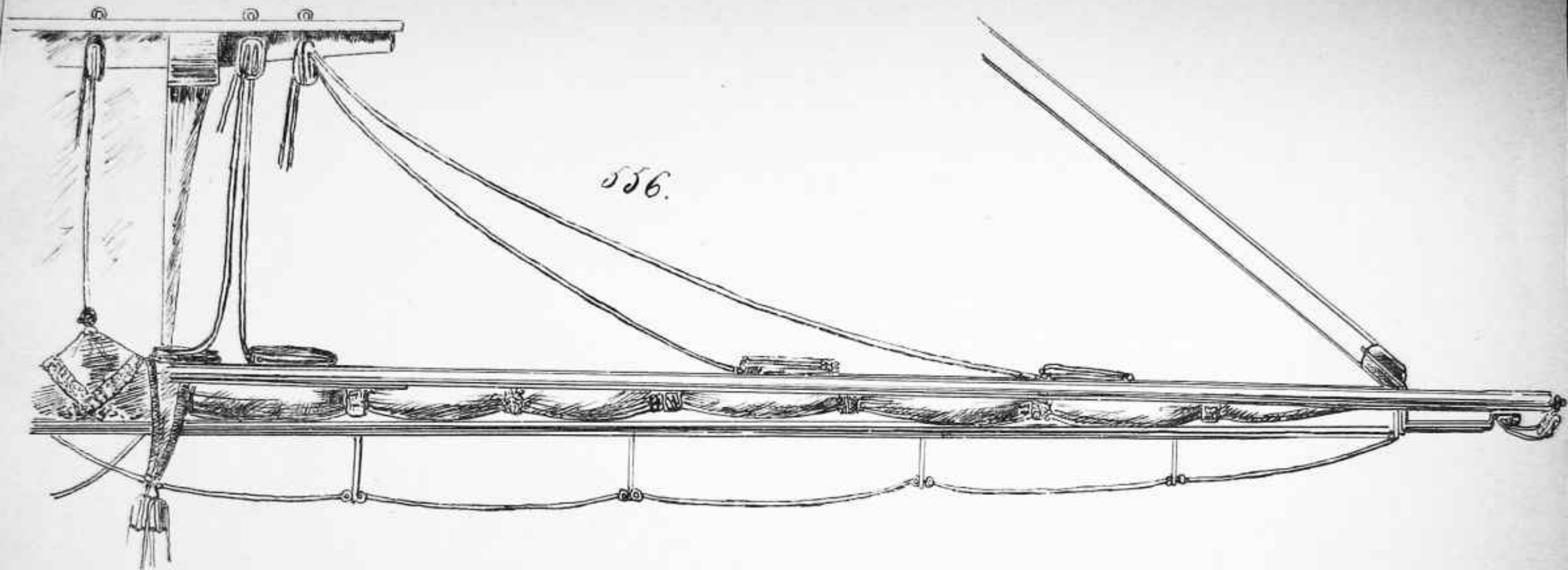

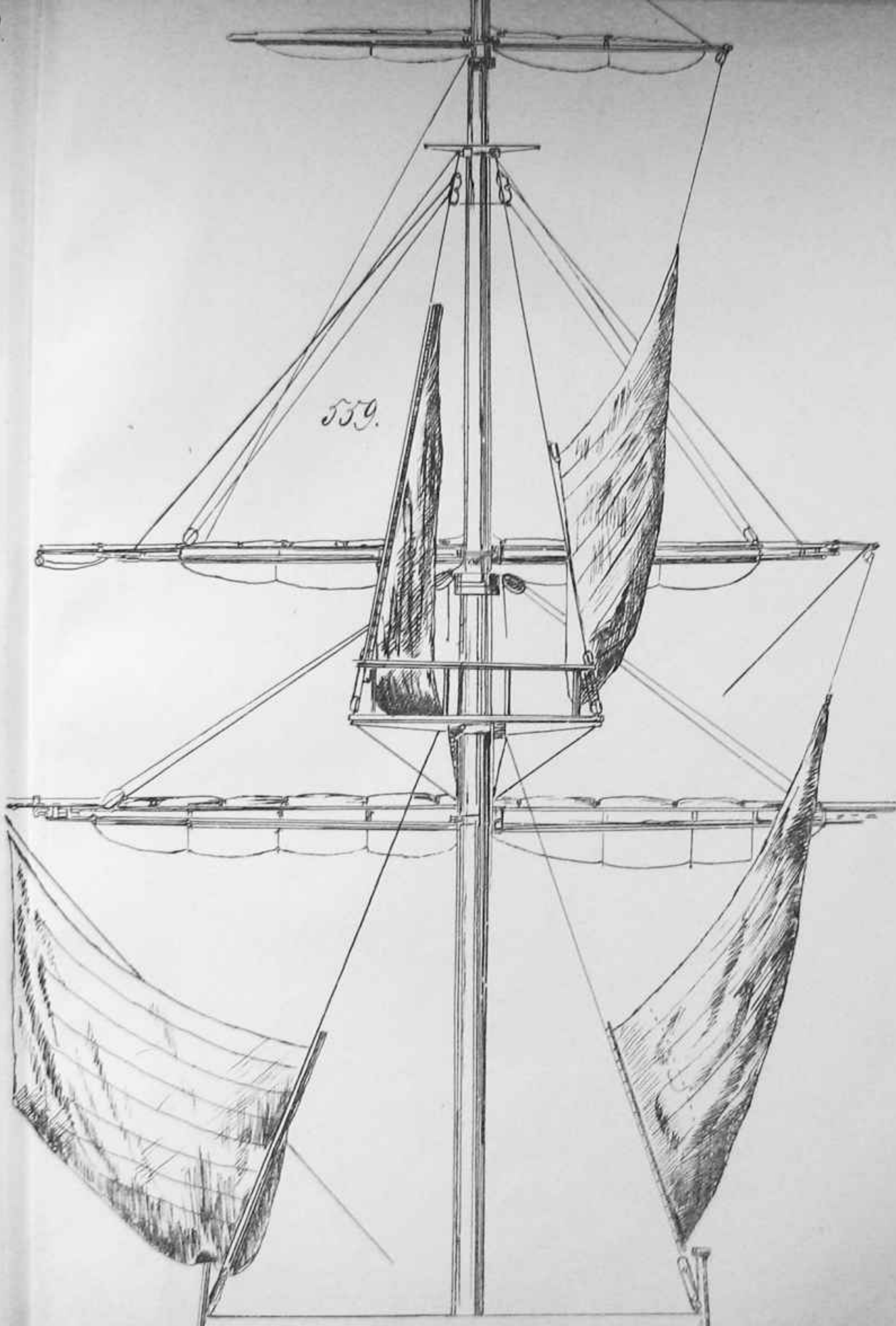

559.

H. de C...

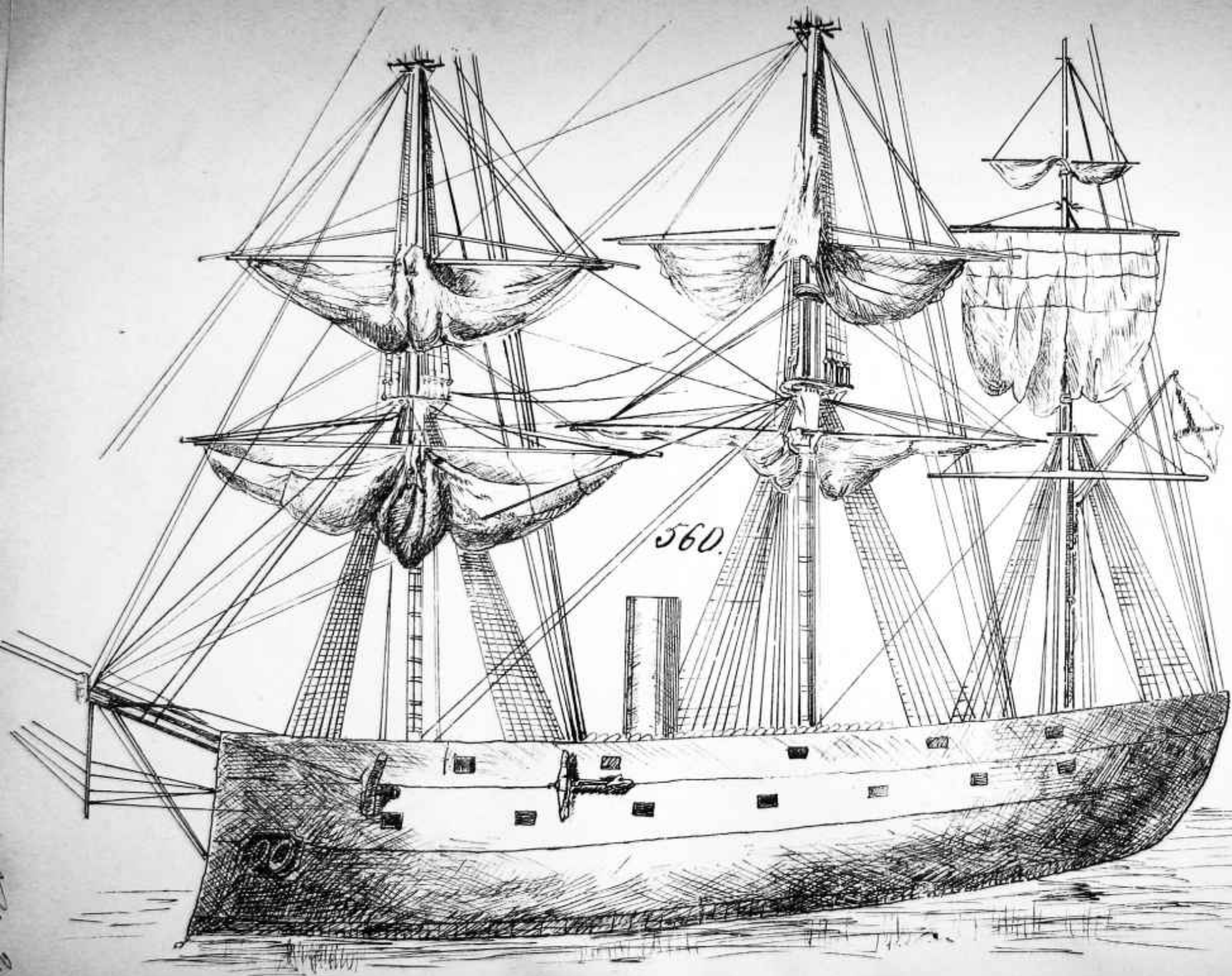

560.



559 }



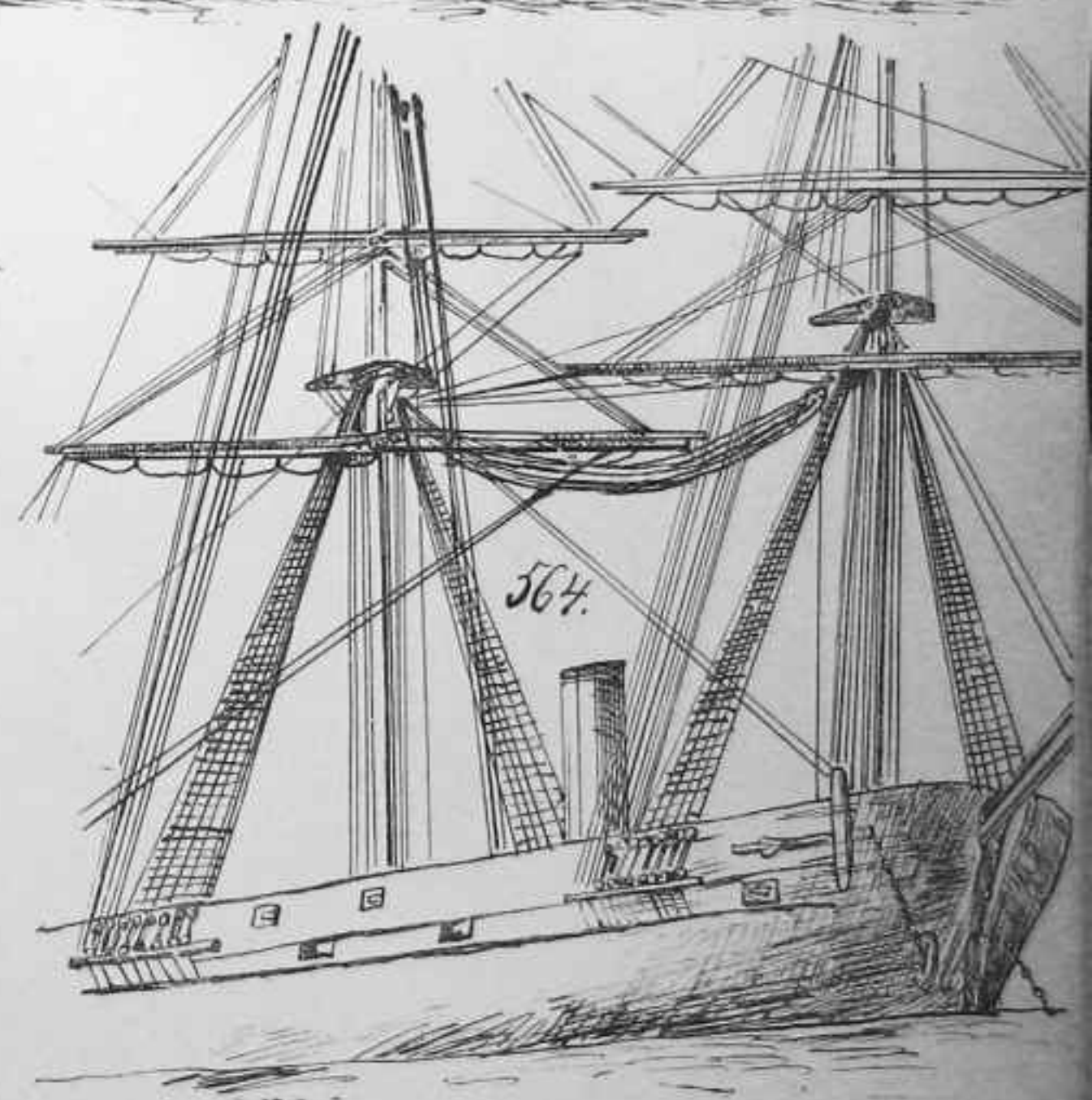
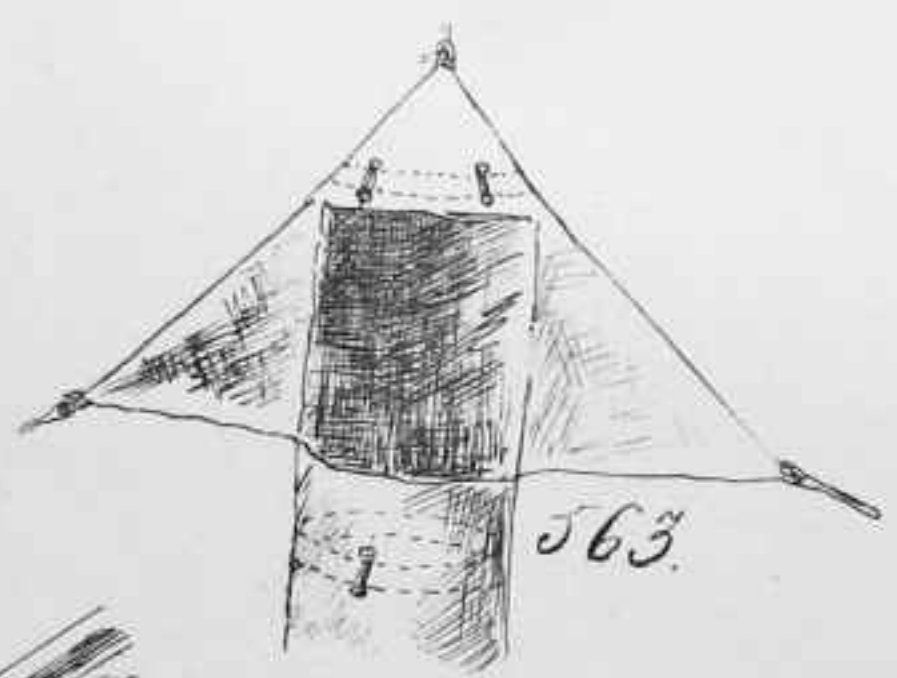
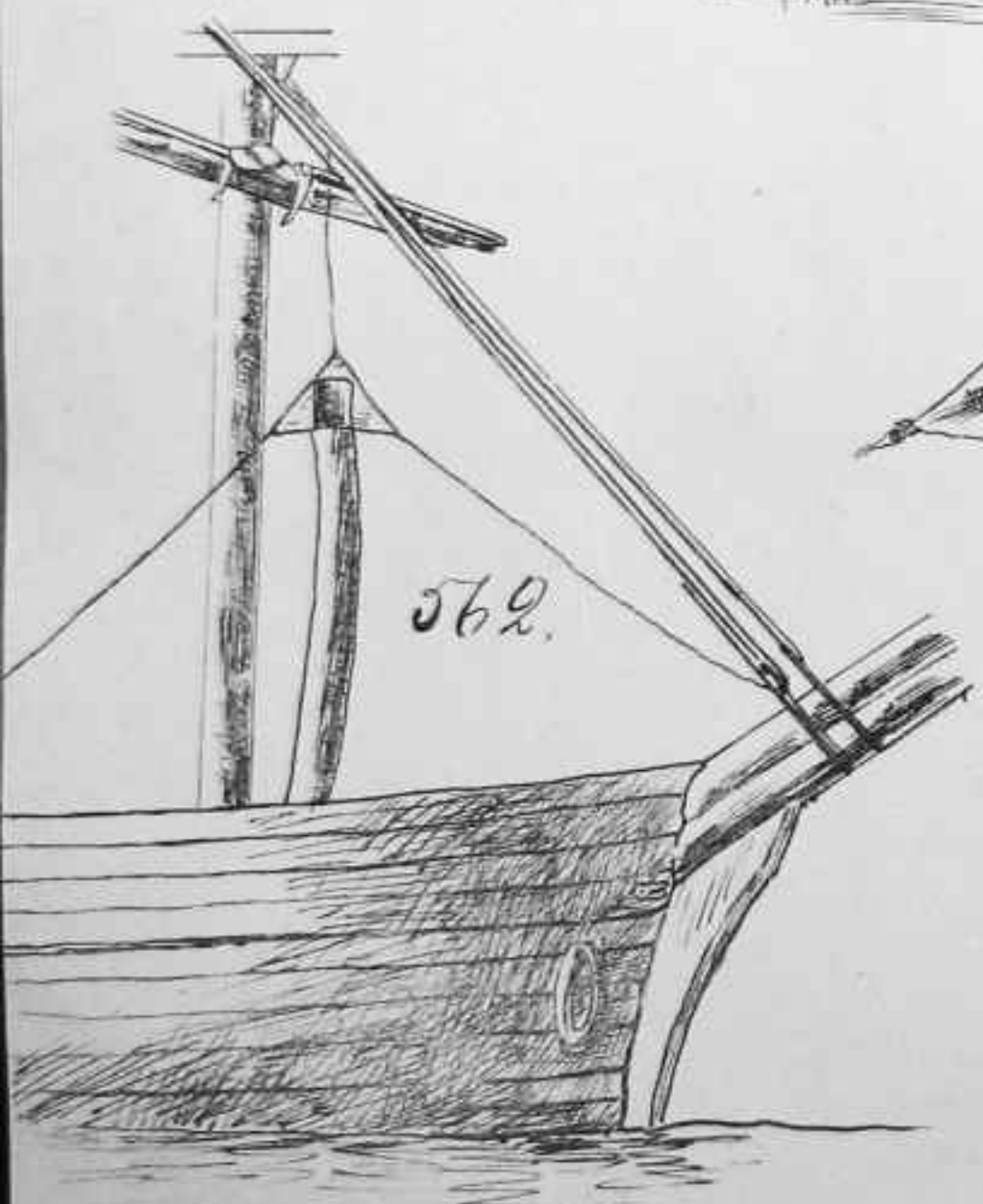
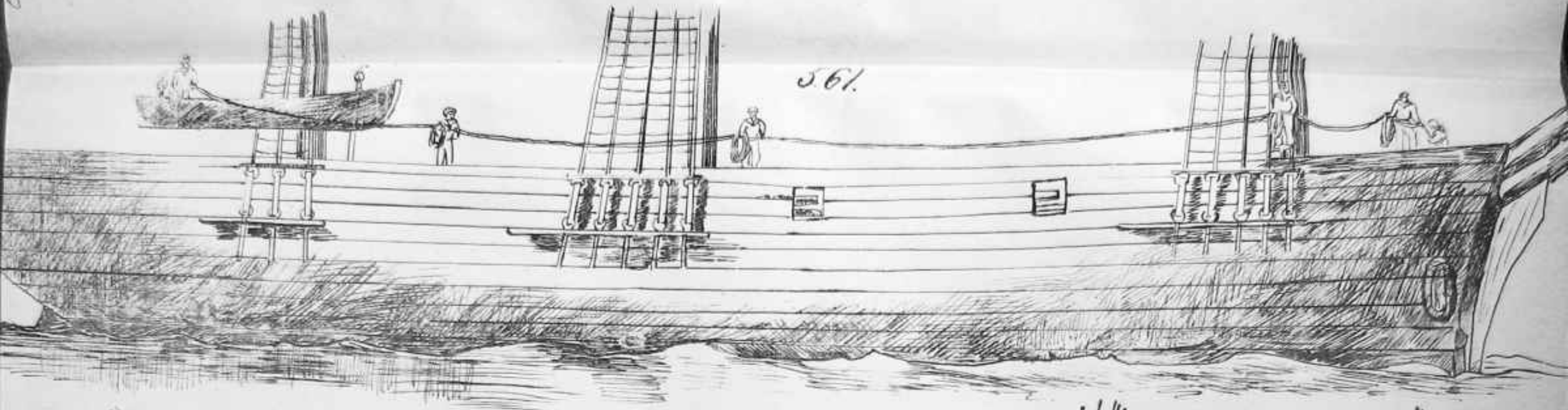

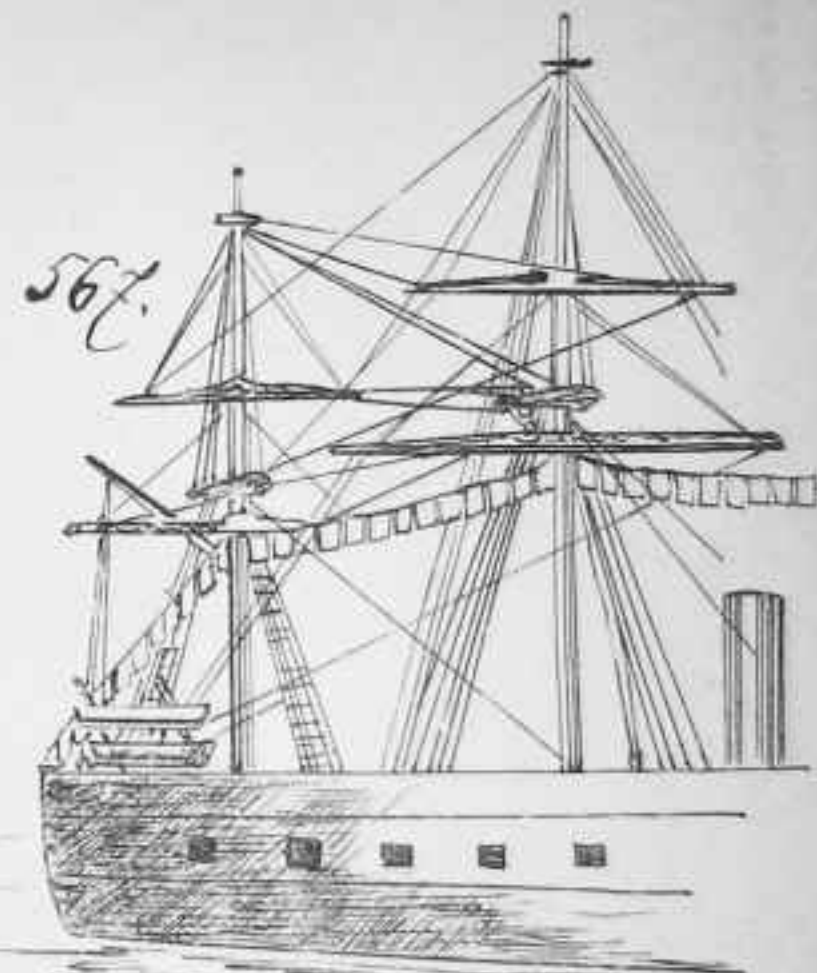
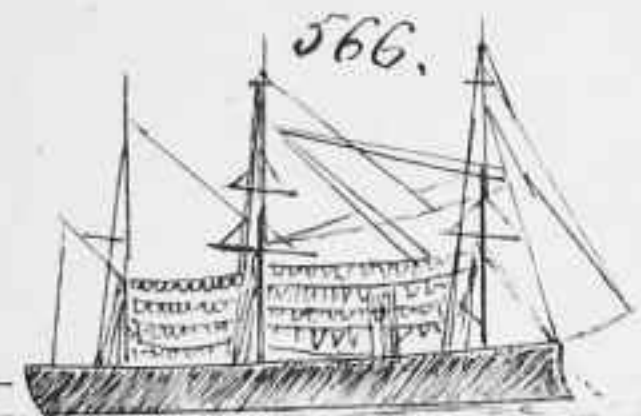
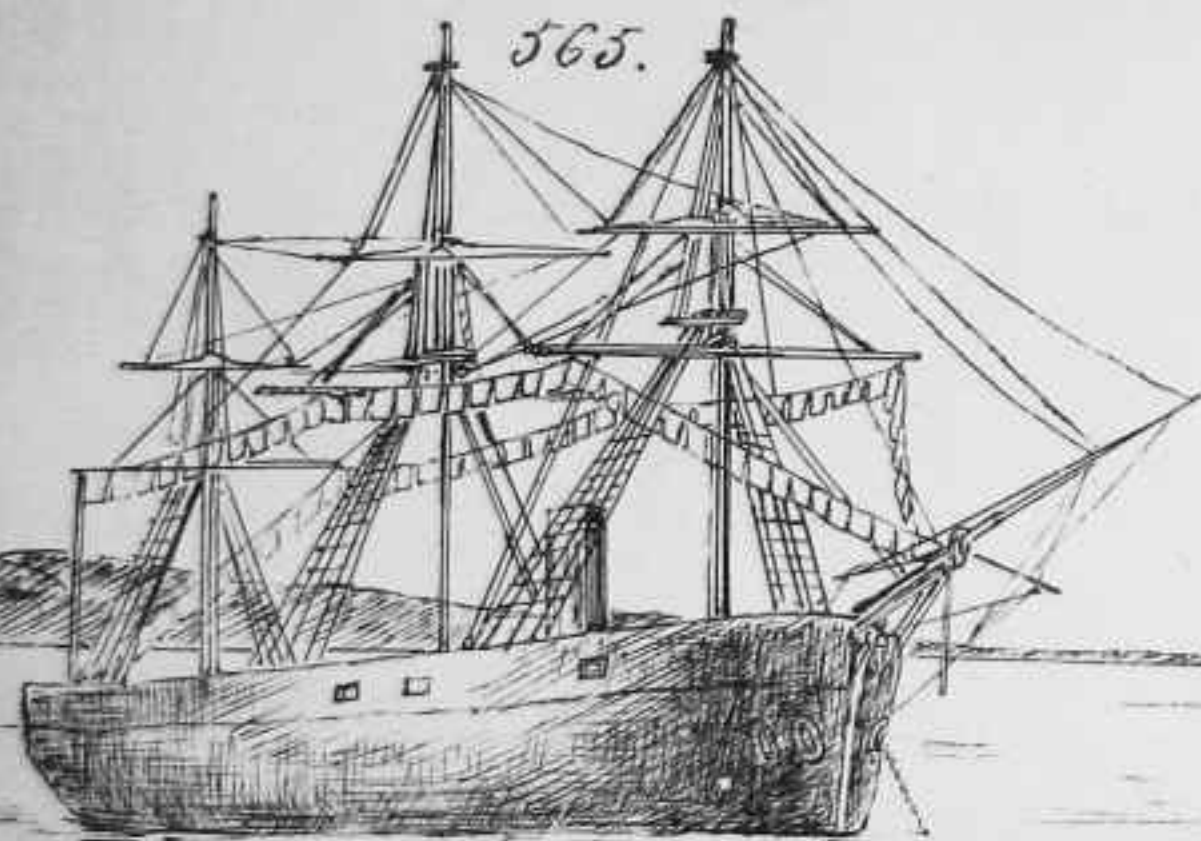

Swan

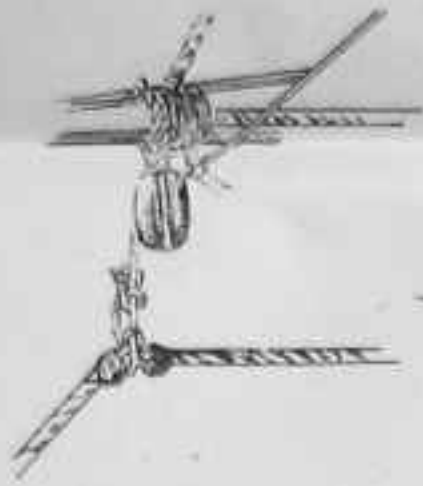

568.

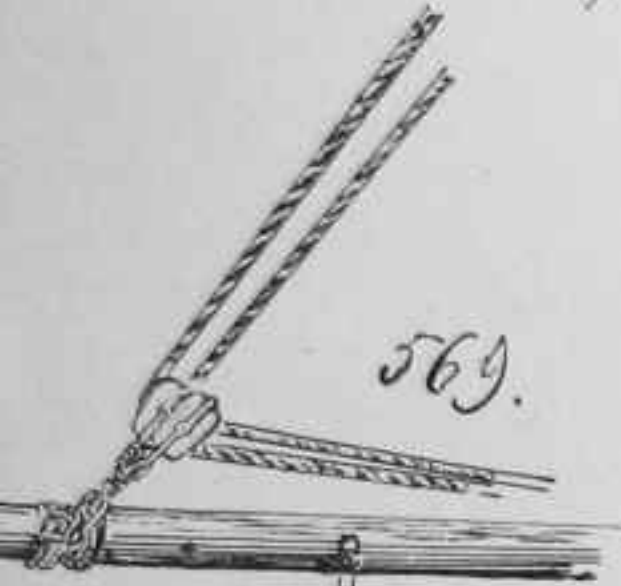

569.

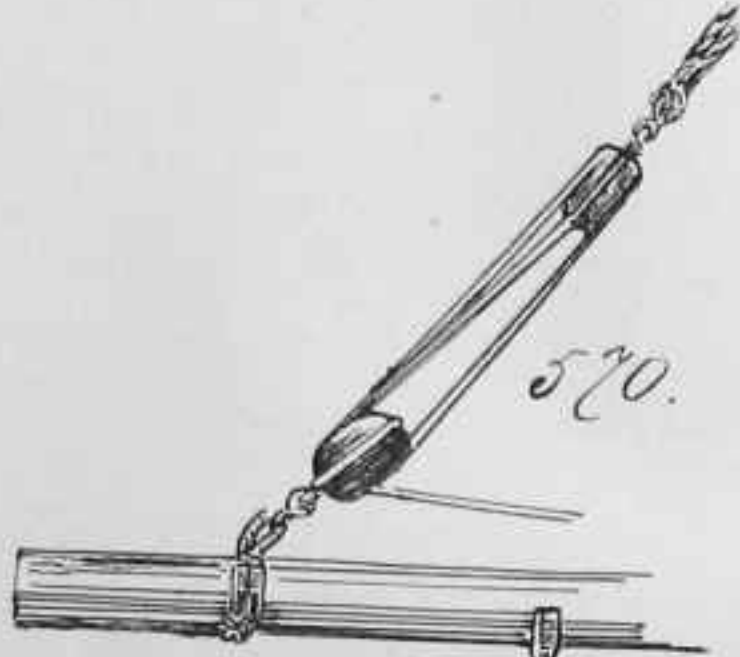

570.

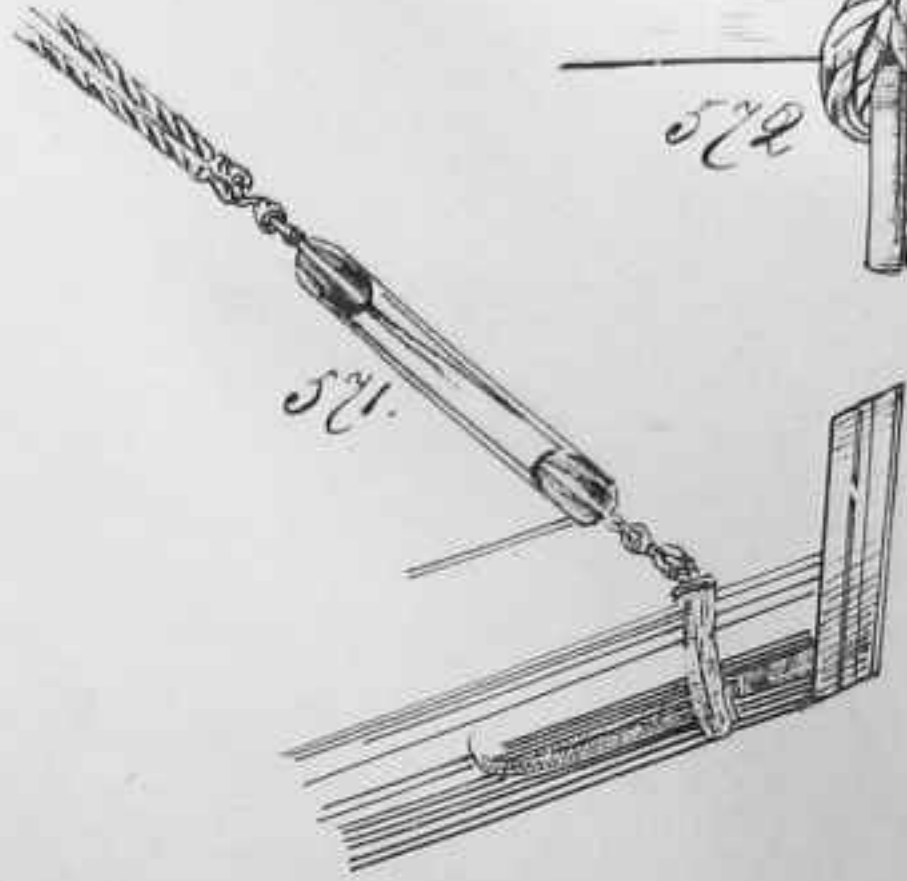

571.



572.



573.



574.

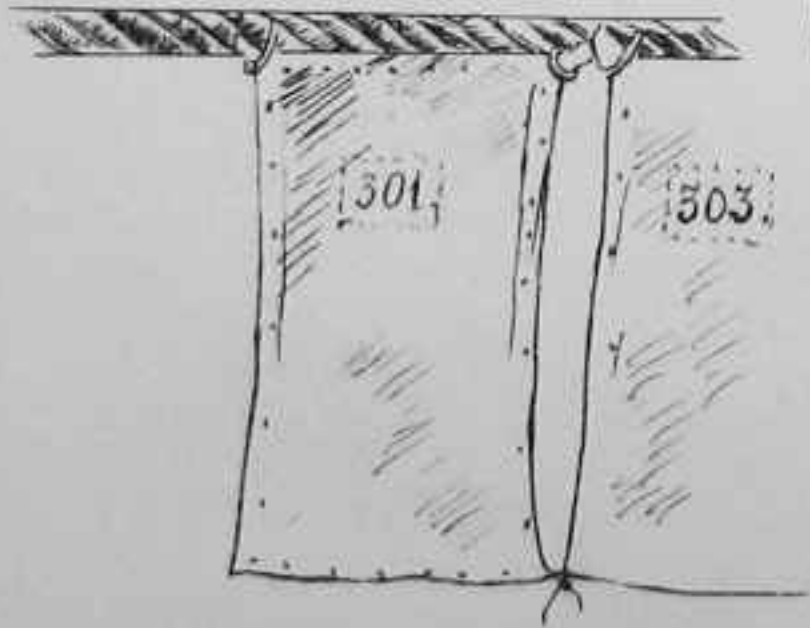

301.

303.

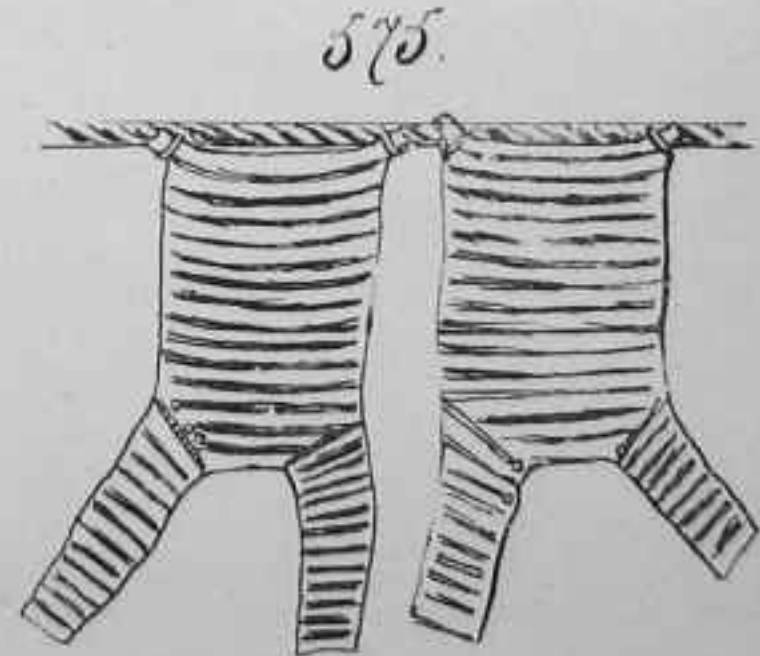

575.

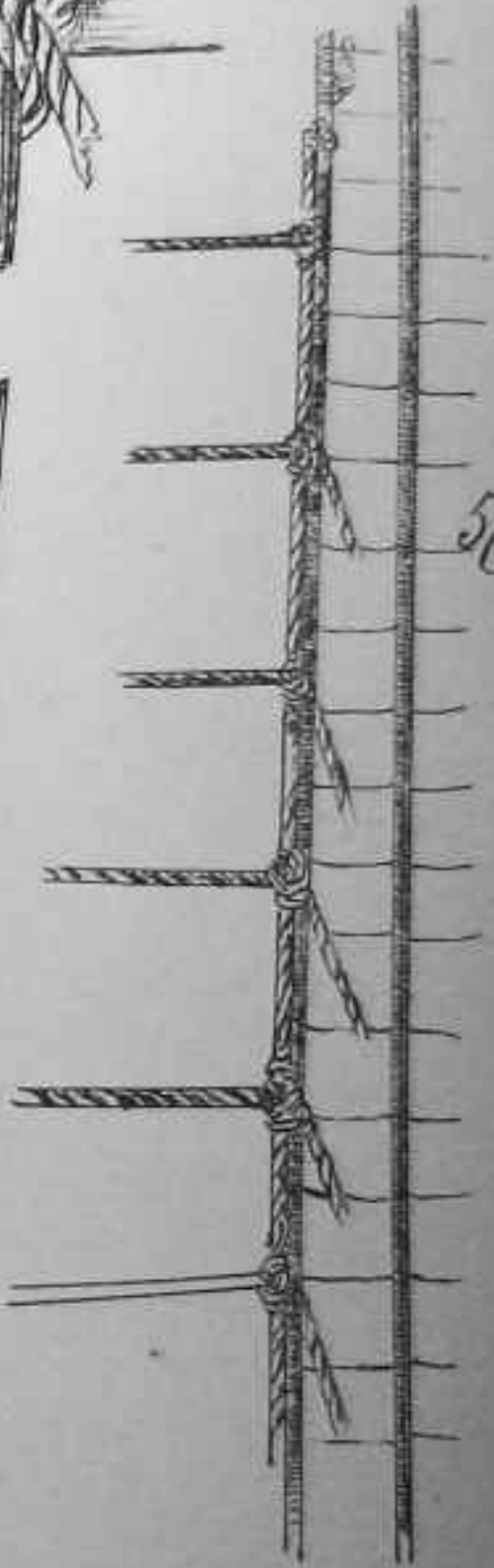

576.

Lucas

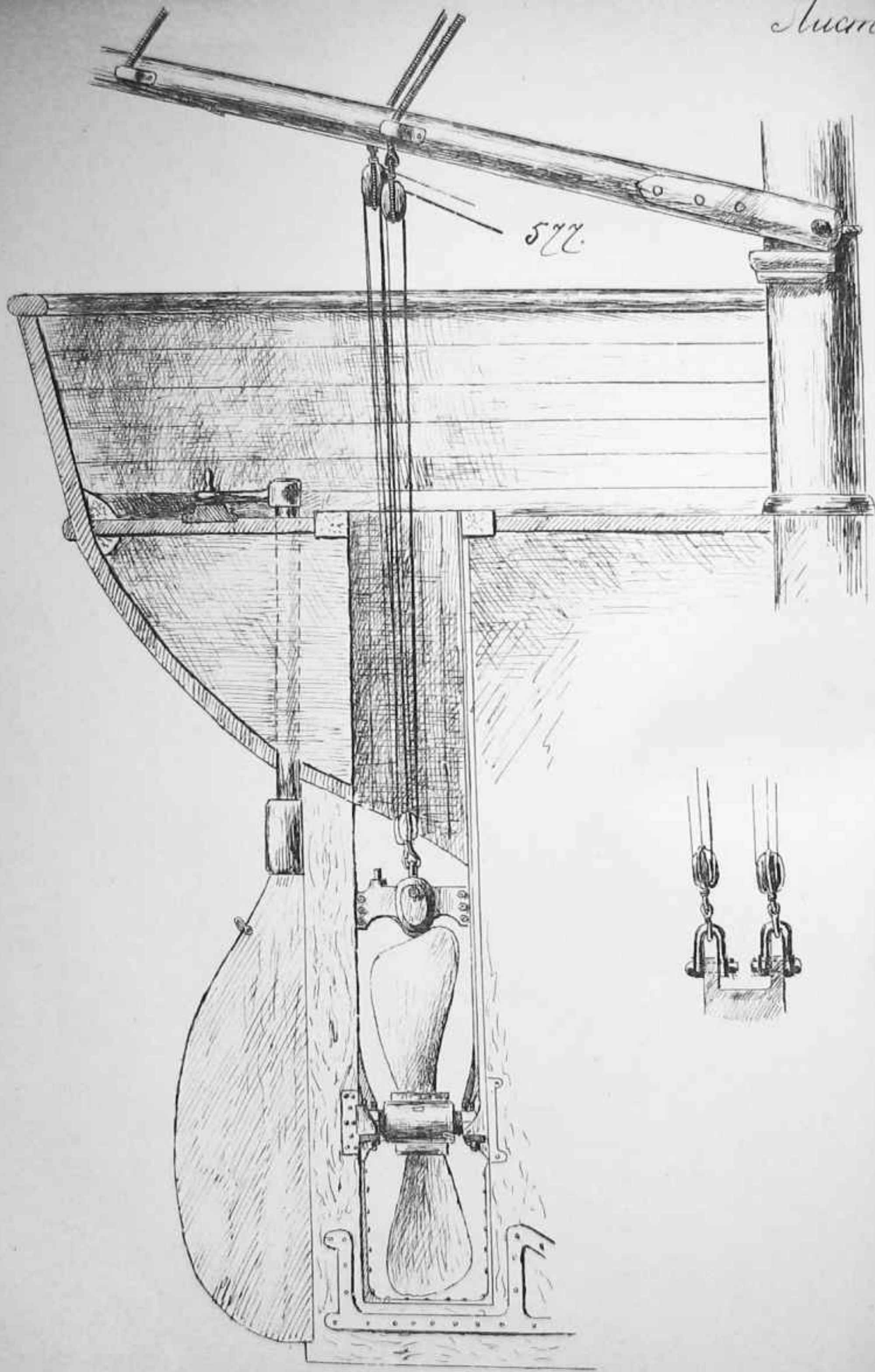

578.

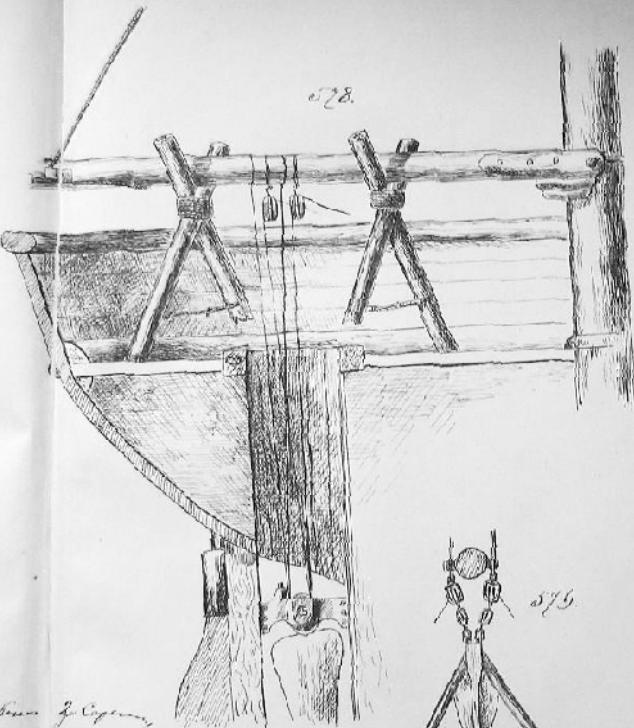

579.

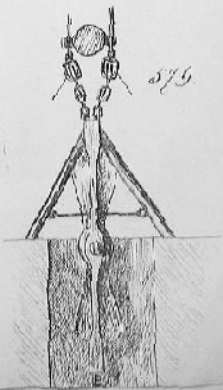

Design of Capt. ...



of water 72

20. 11. 1880

Fig 1

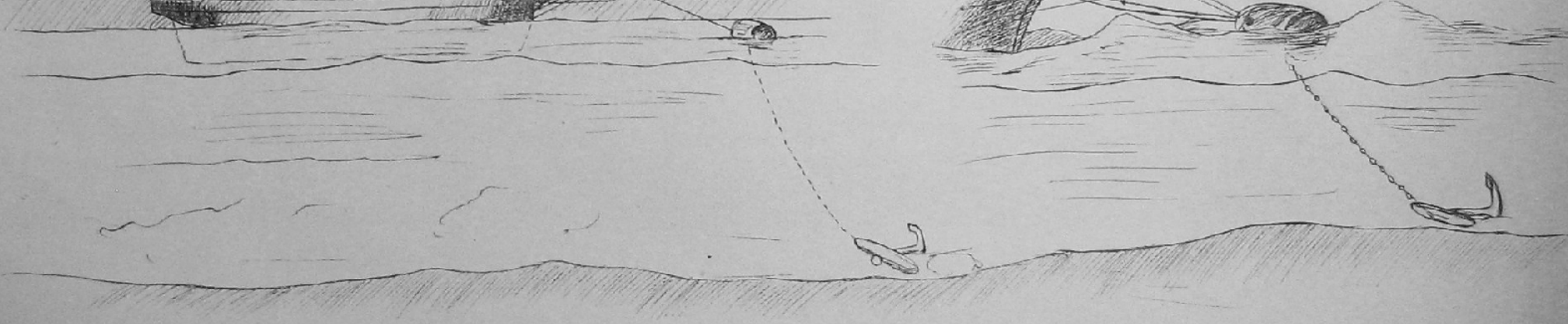
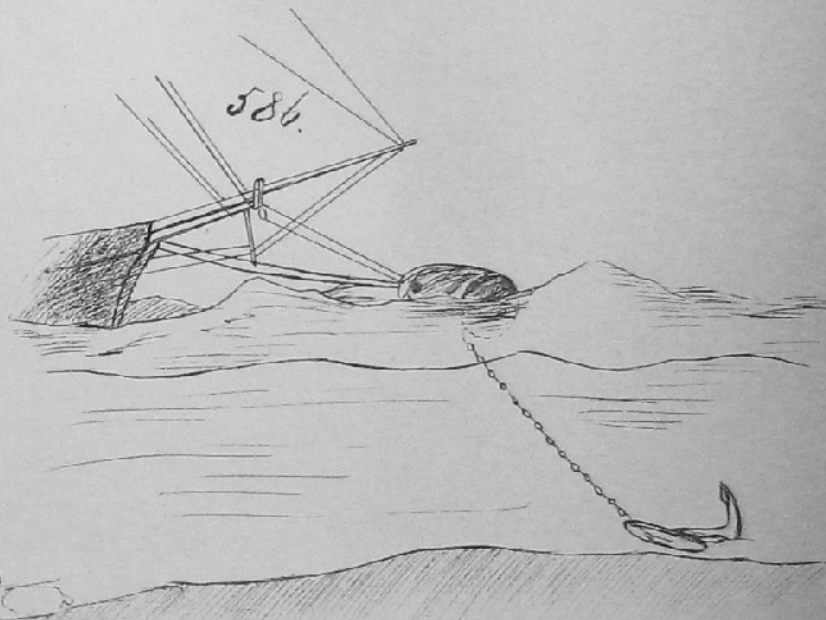
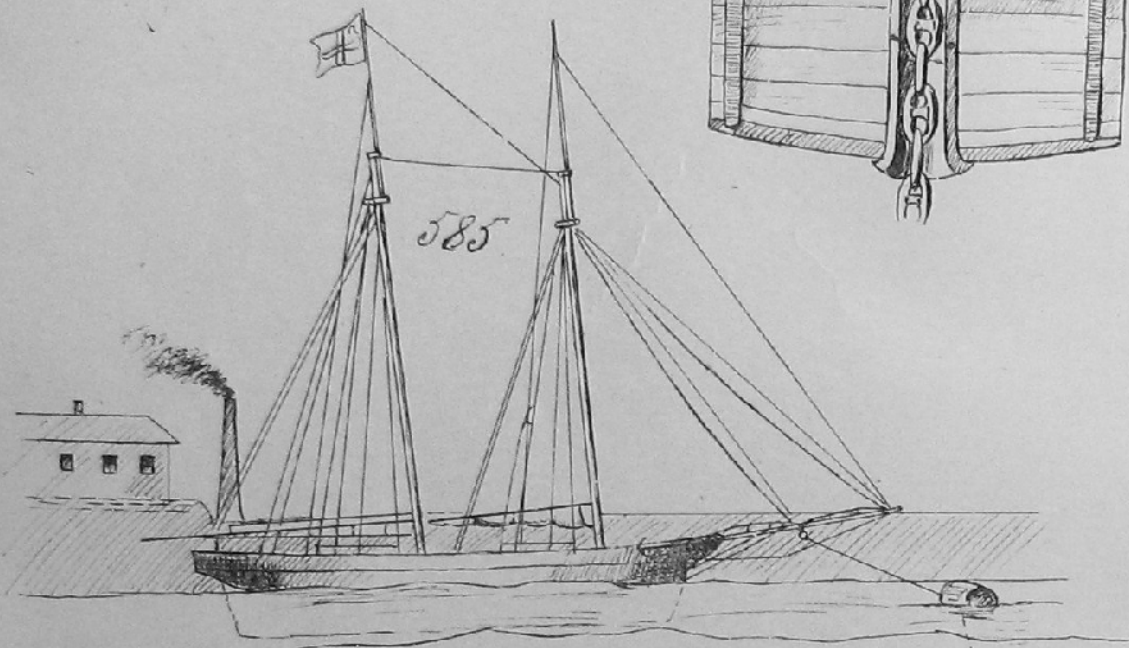
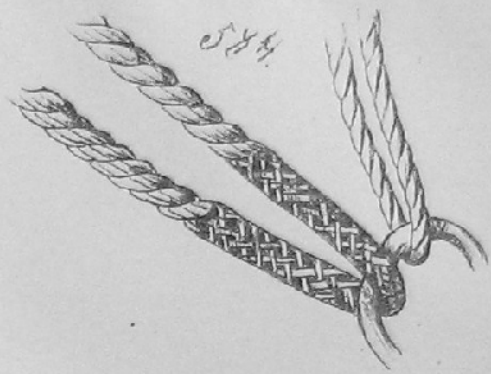
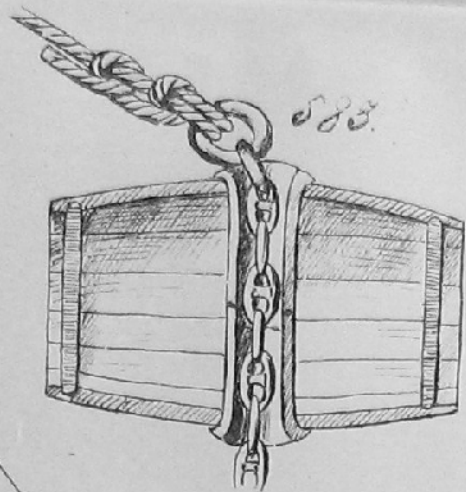

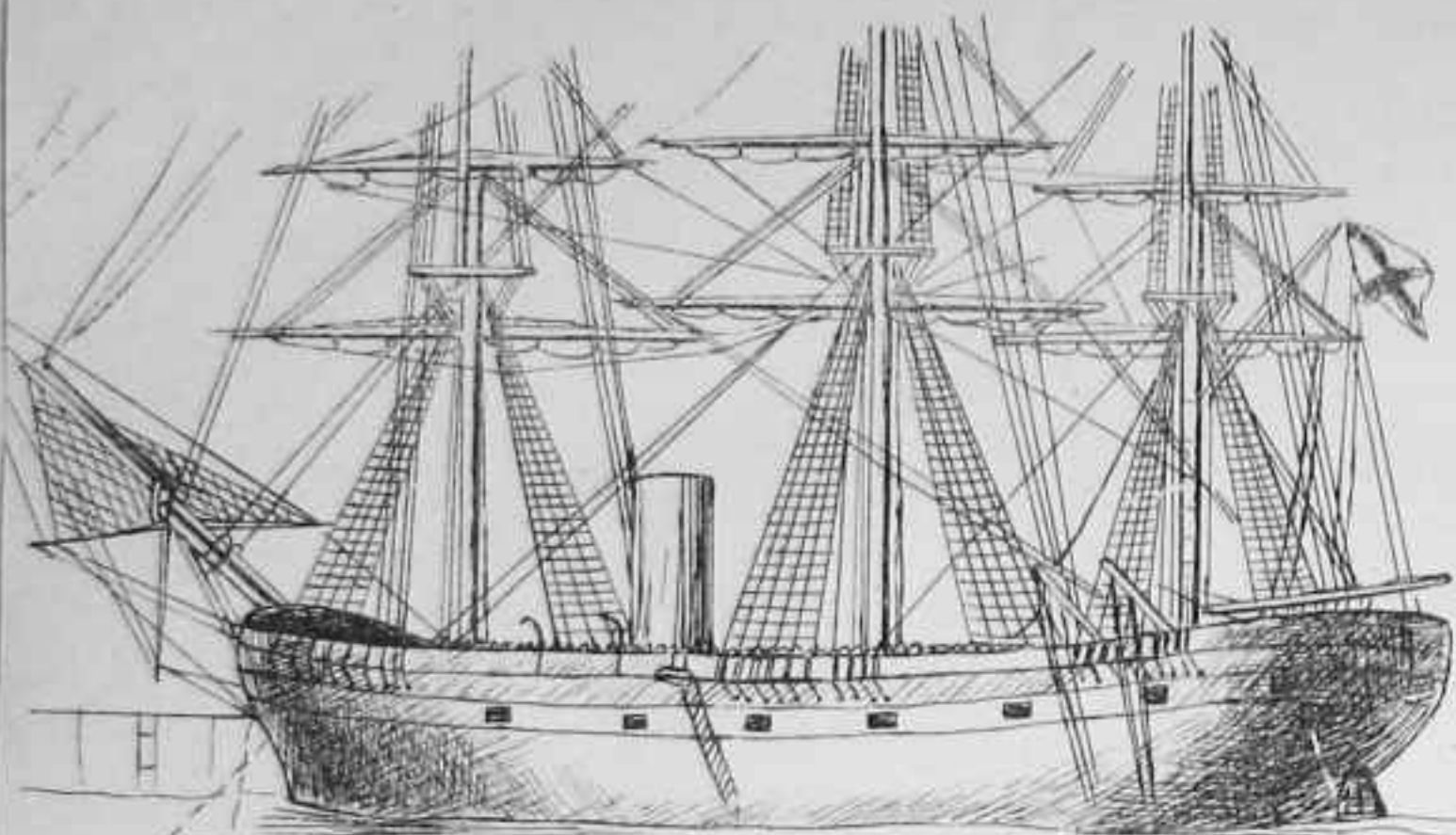

587.

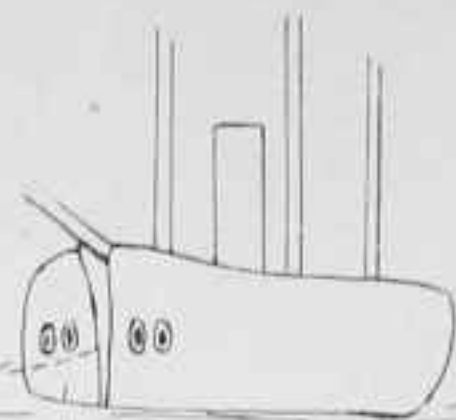

588

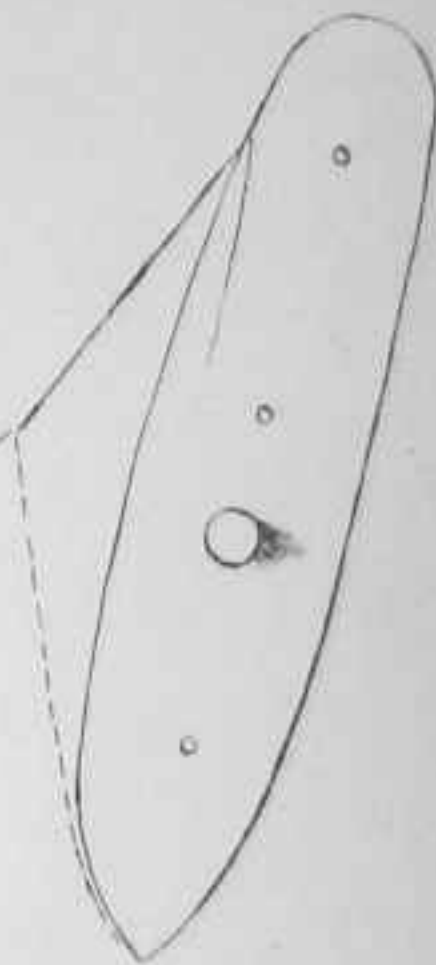

589



Kan 20 19 years

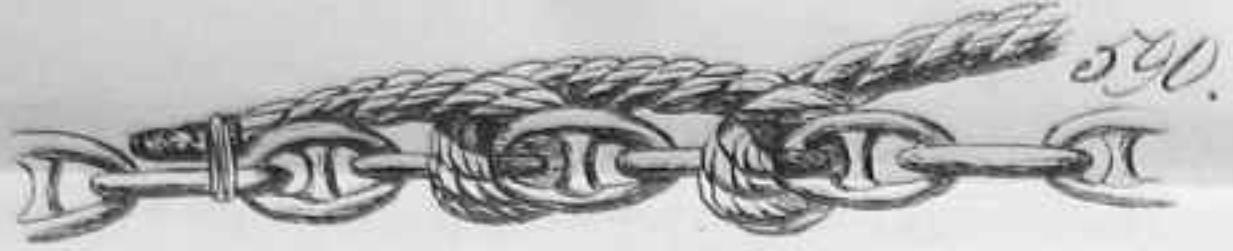

June 24

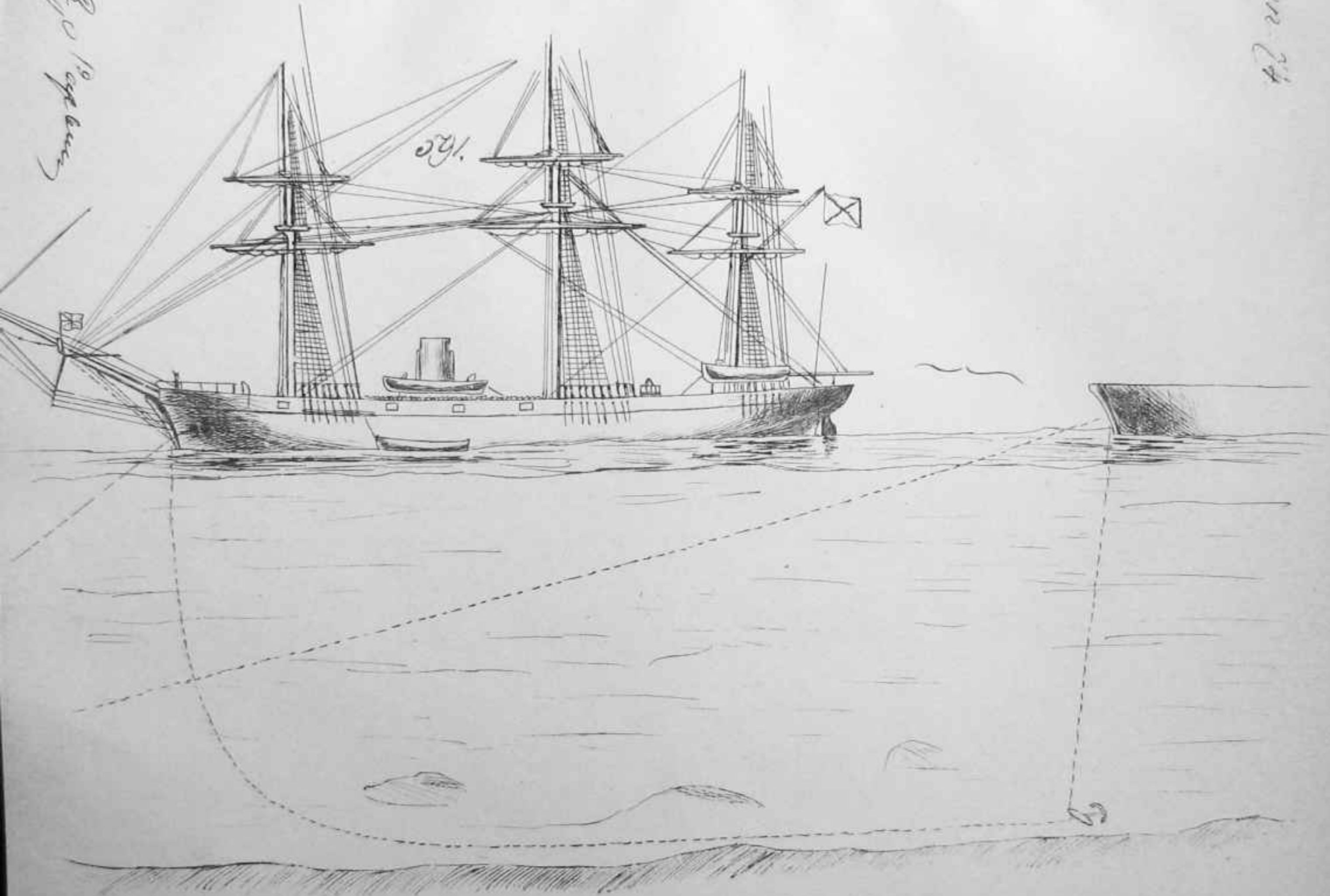

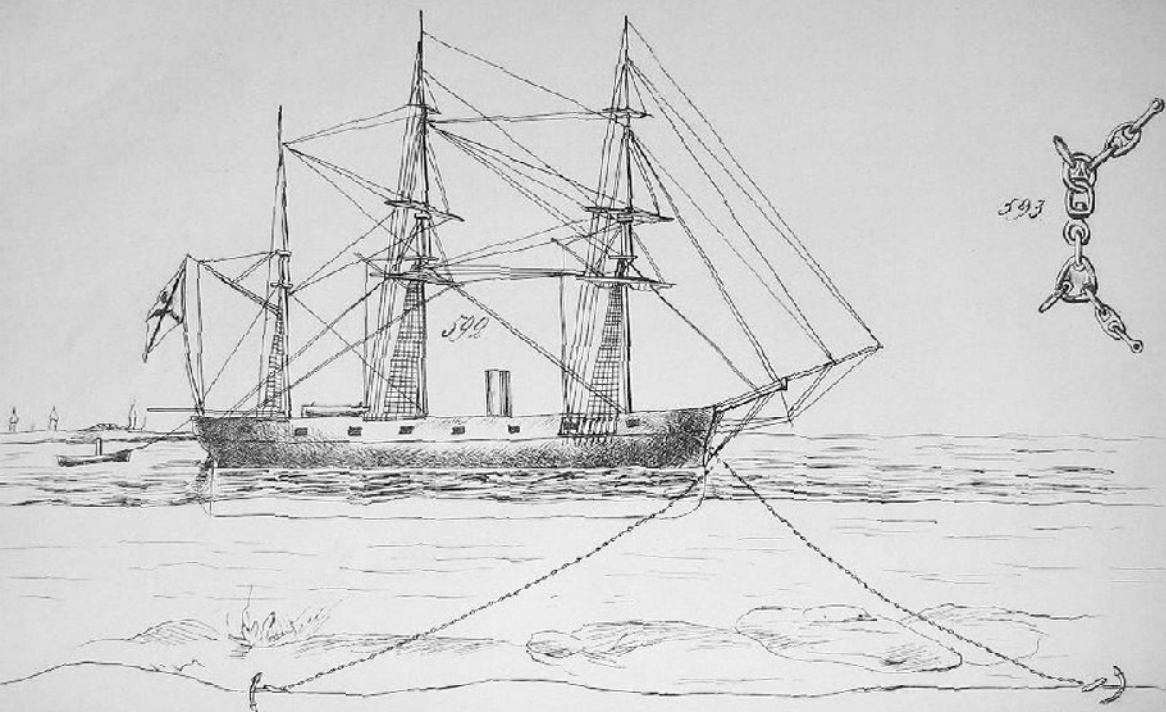

593

590



594



1871
25

kan go veyrum

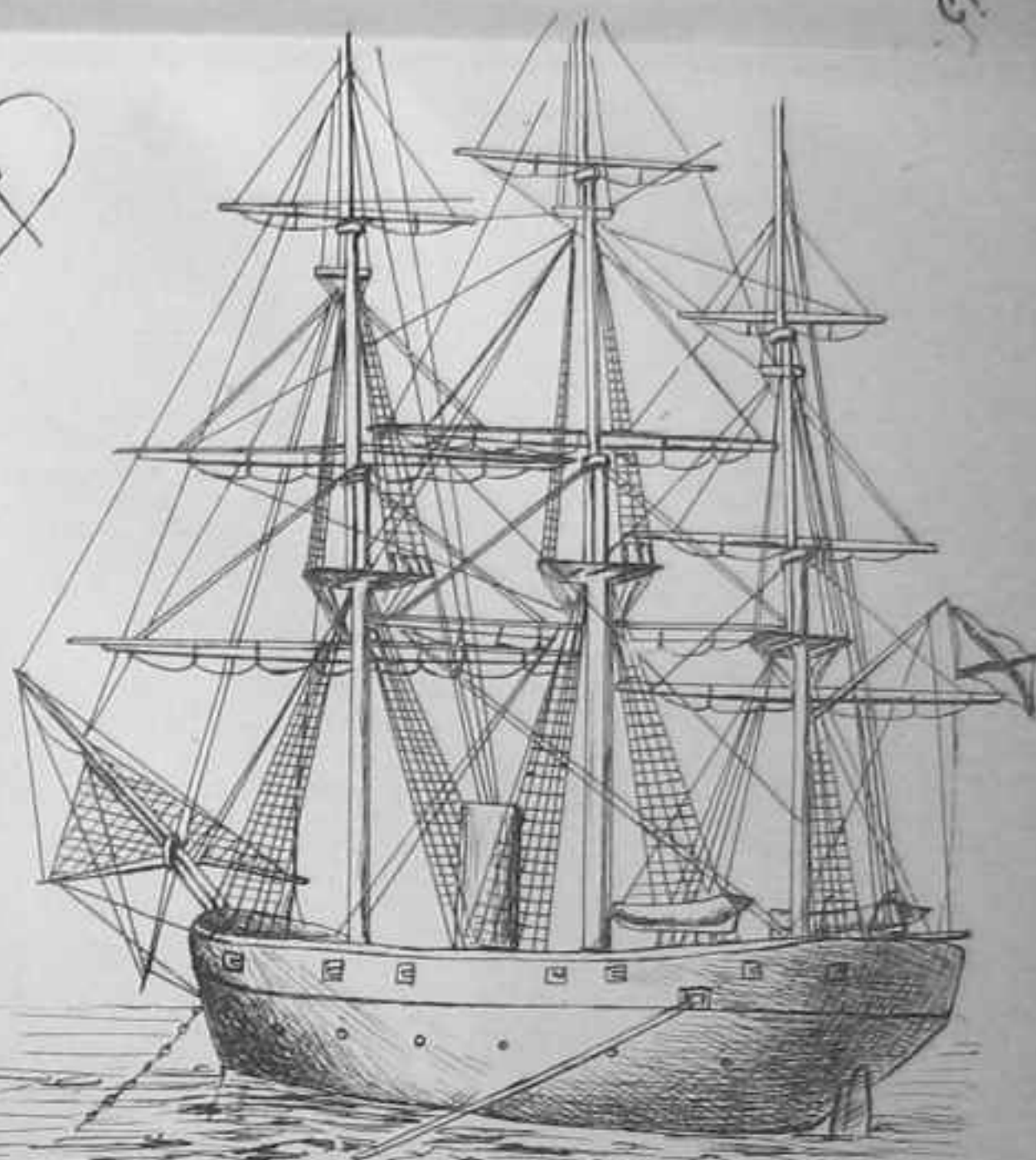
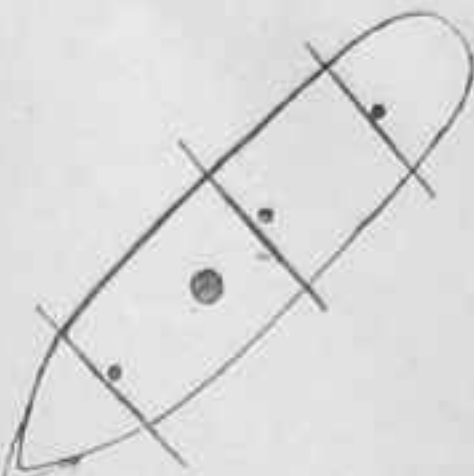

595

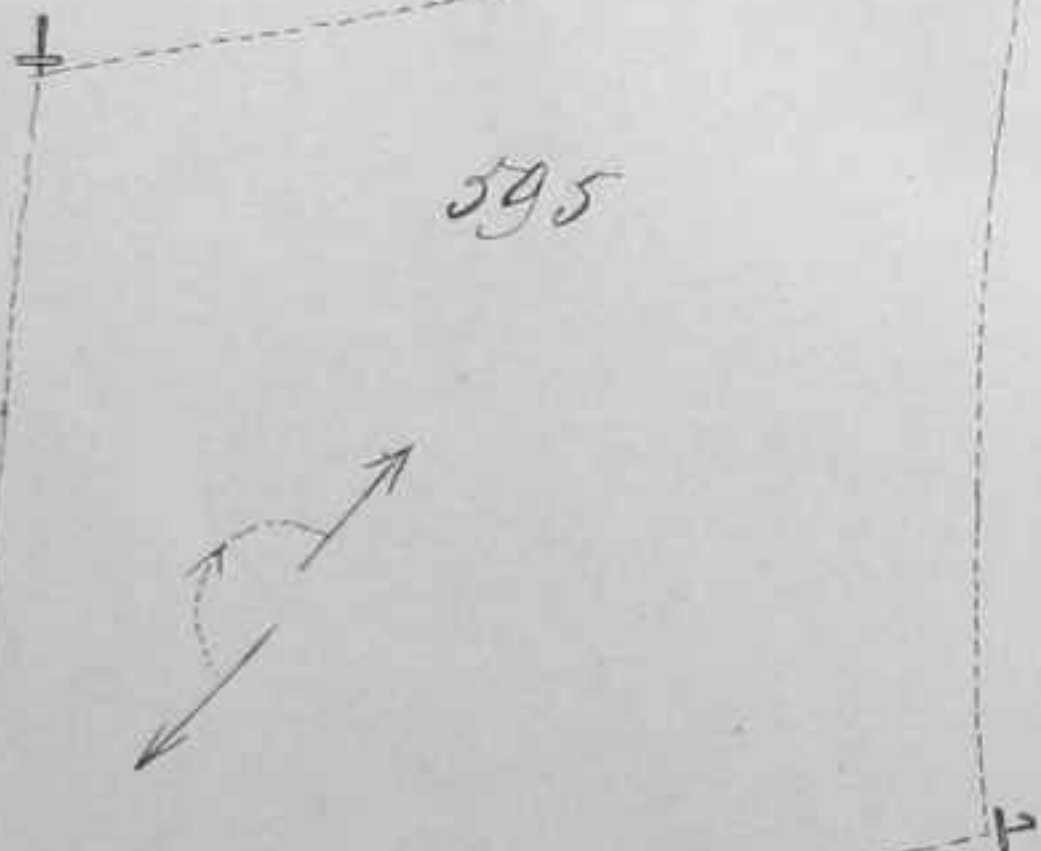

596

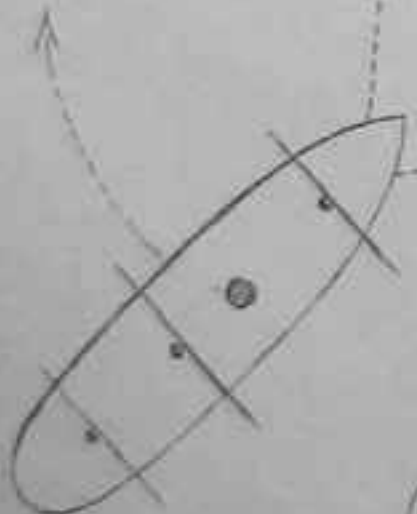



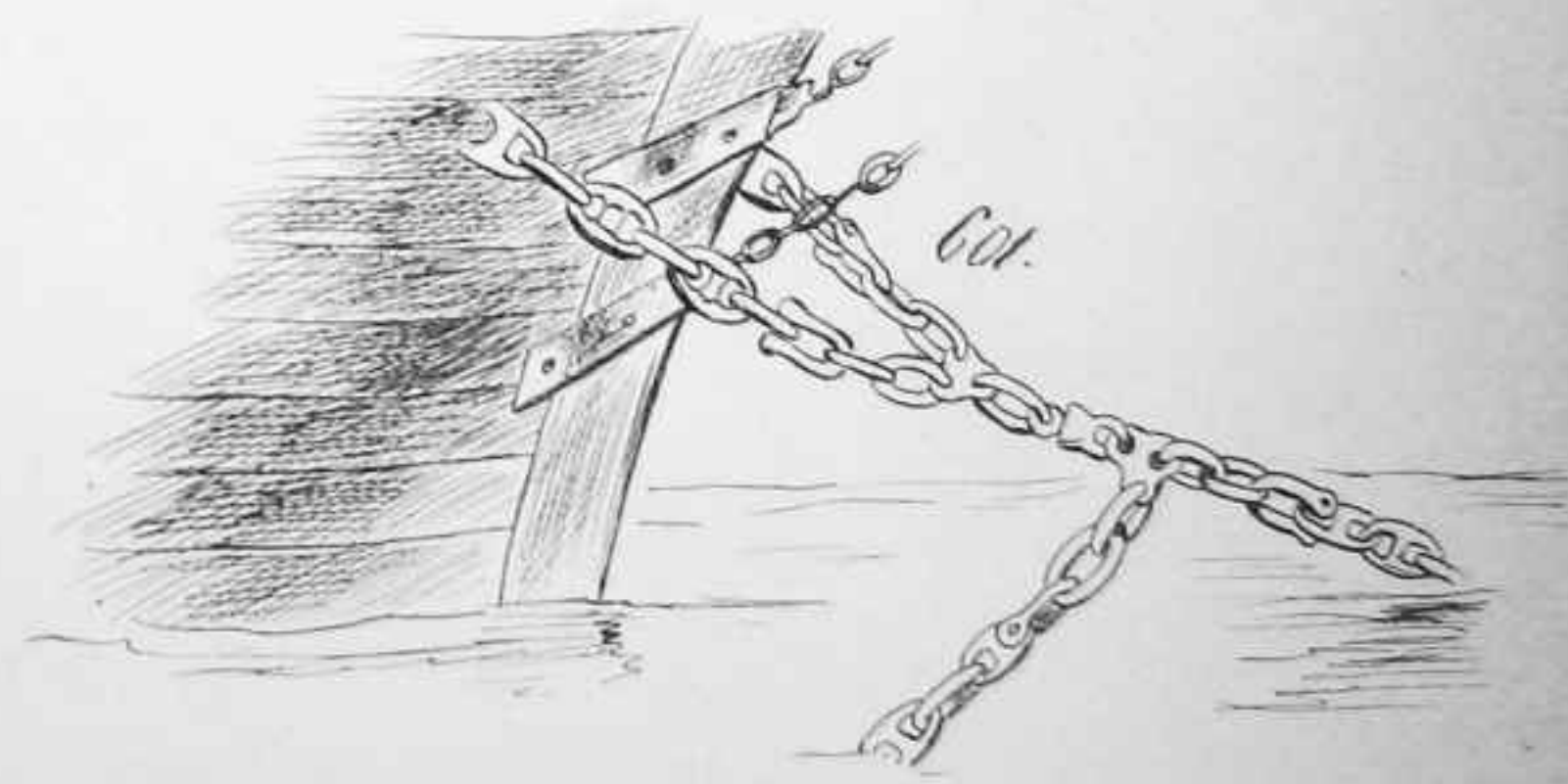
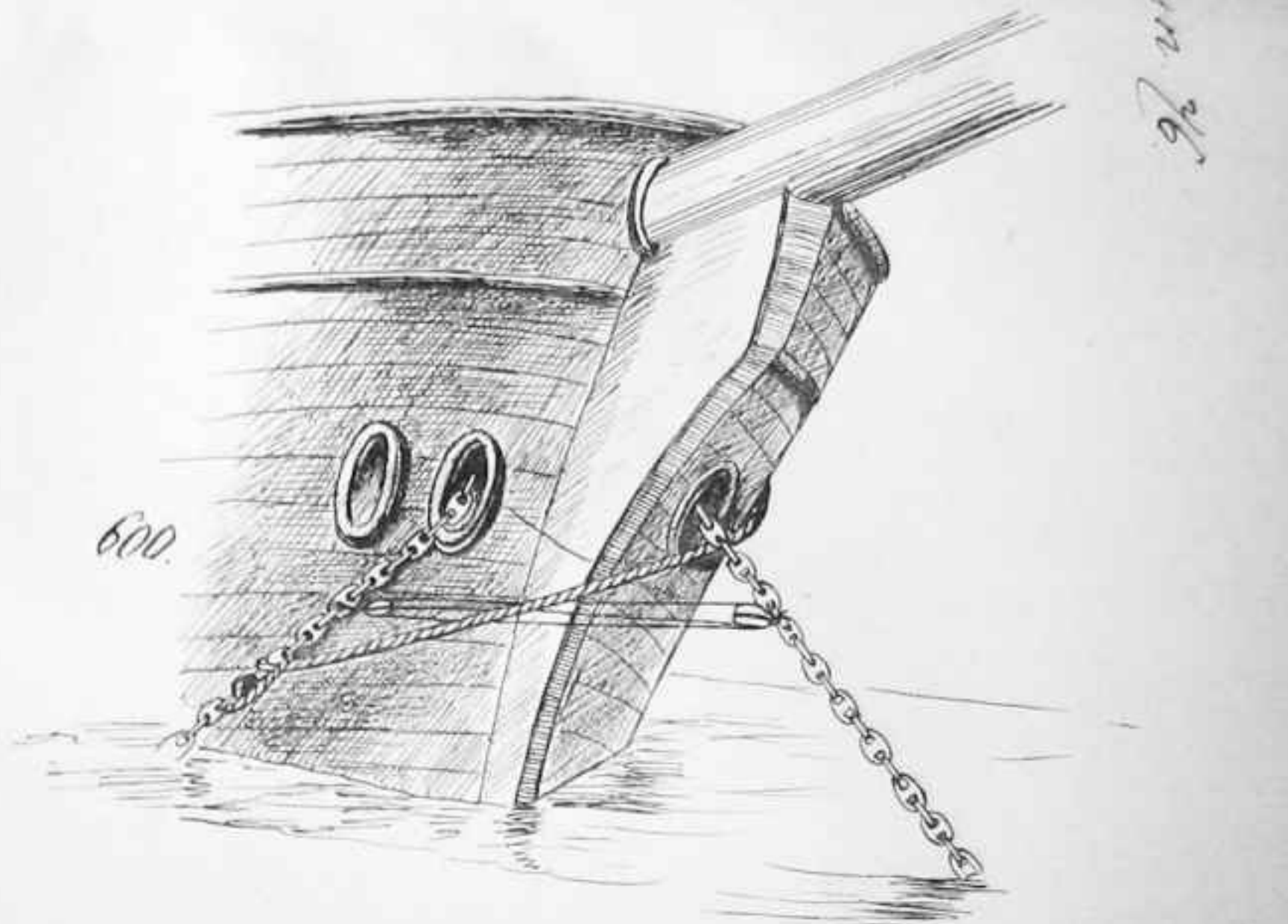
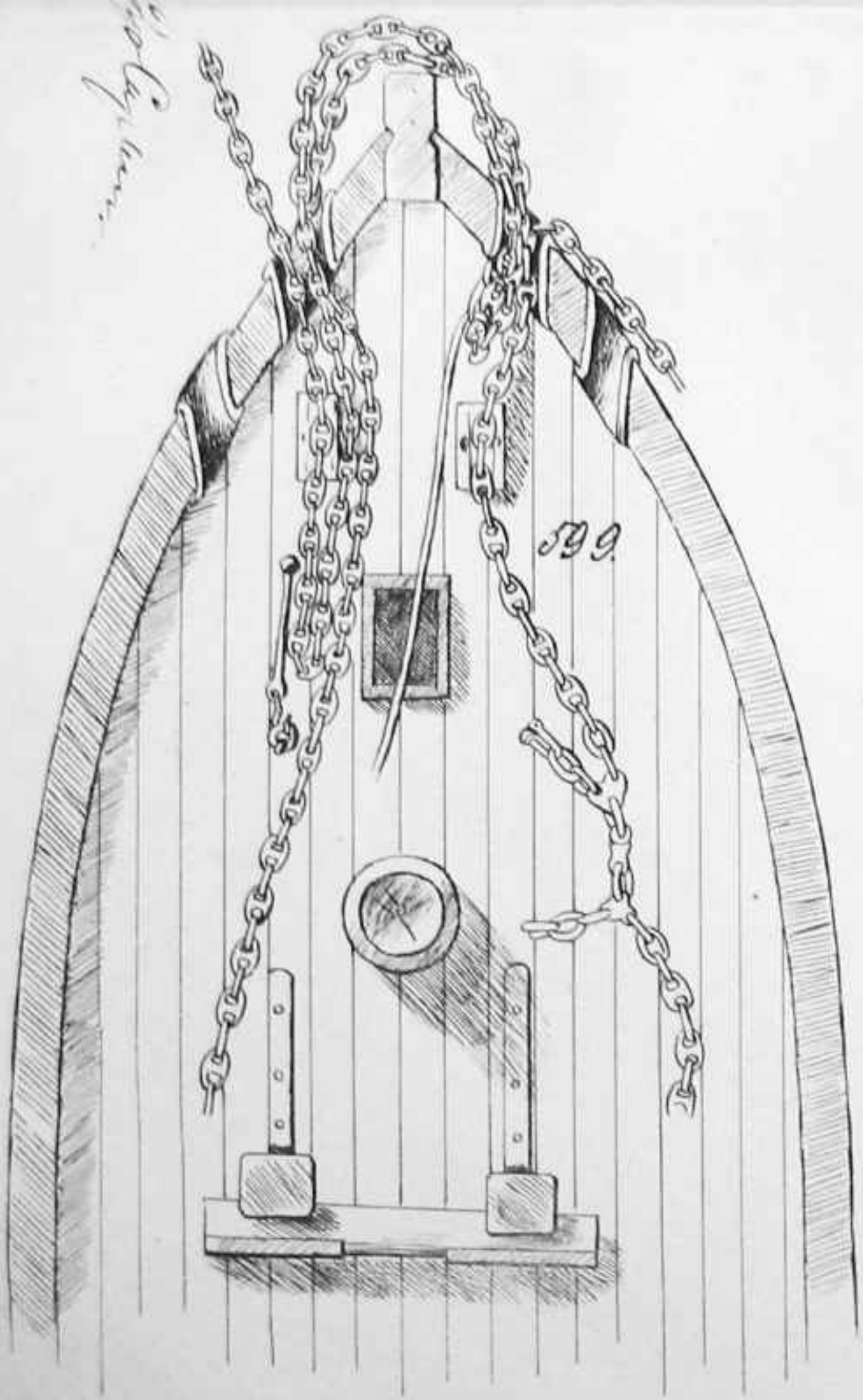

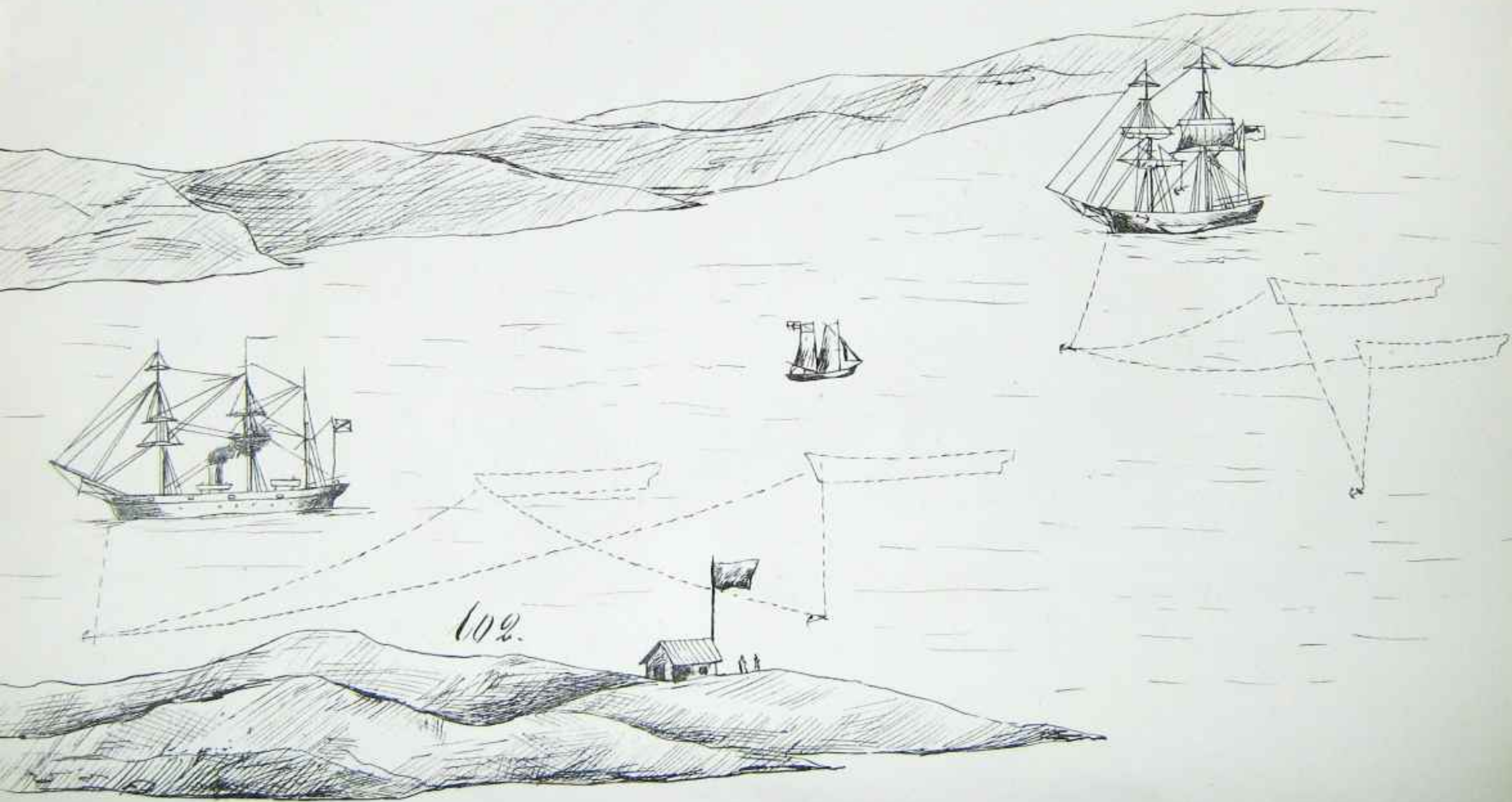

102.

1/2

Sp. Captains

m. 27.

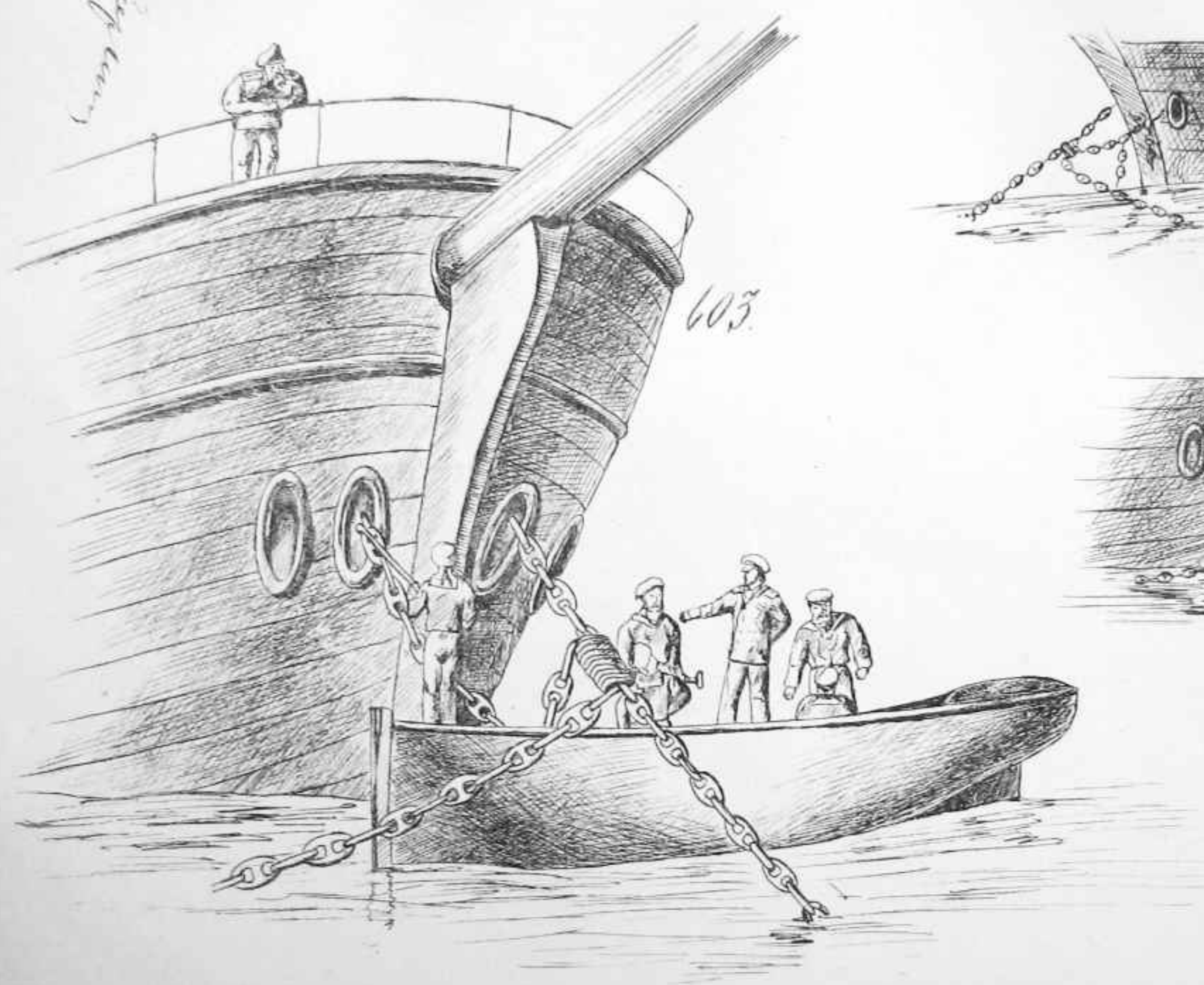

603.

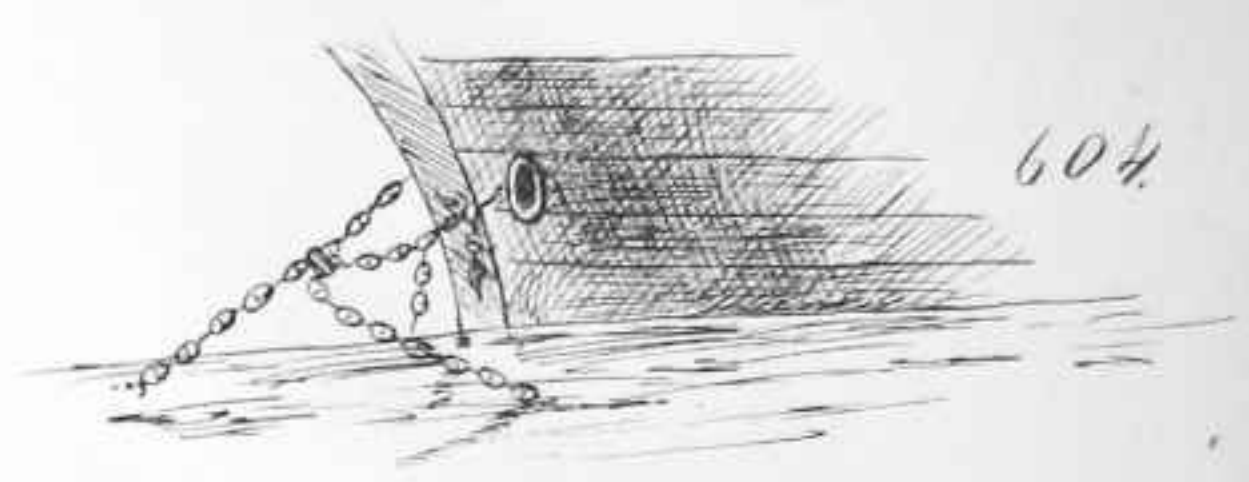

604.

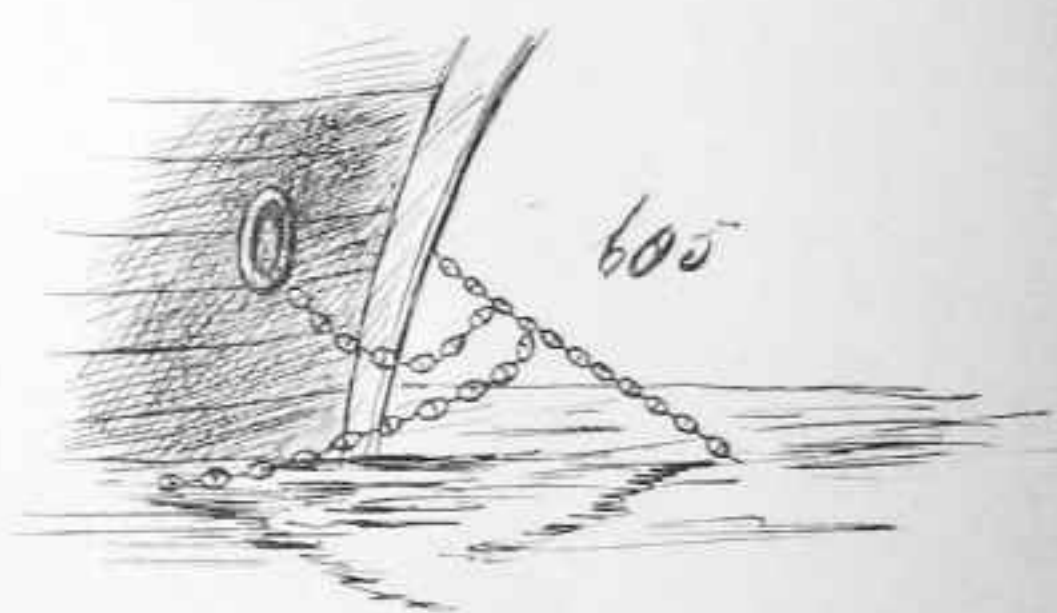

605.

Aug 78.

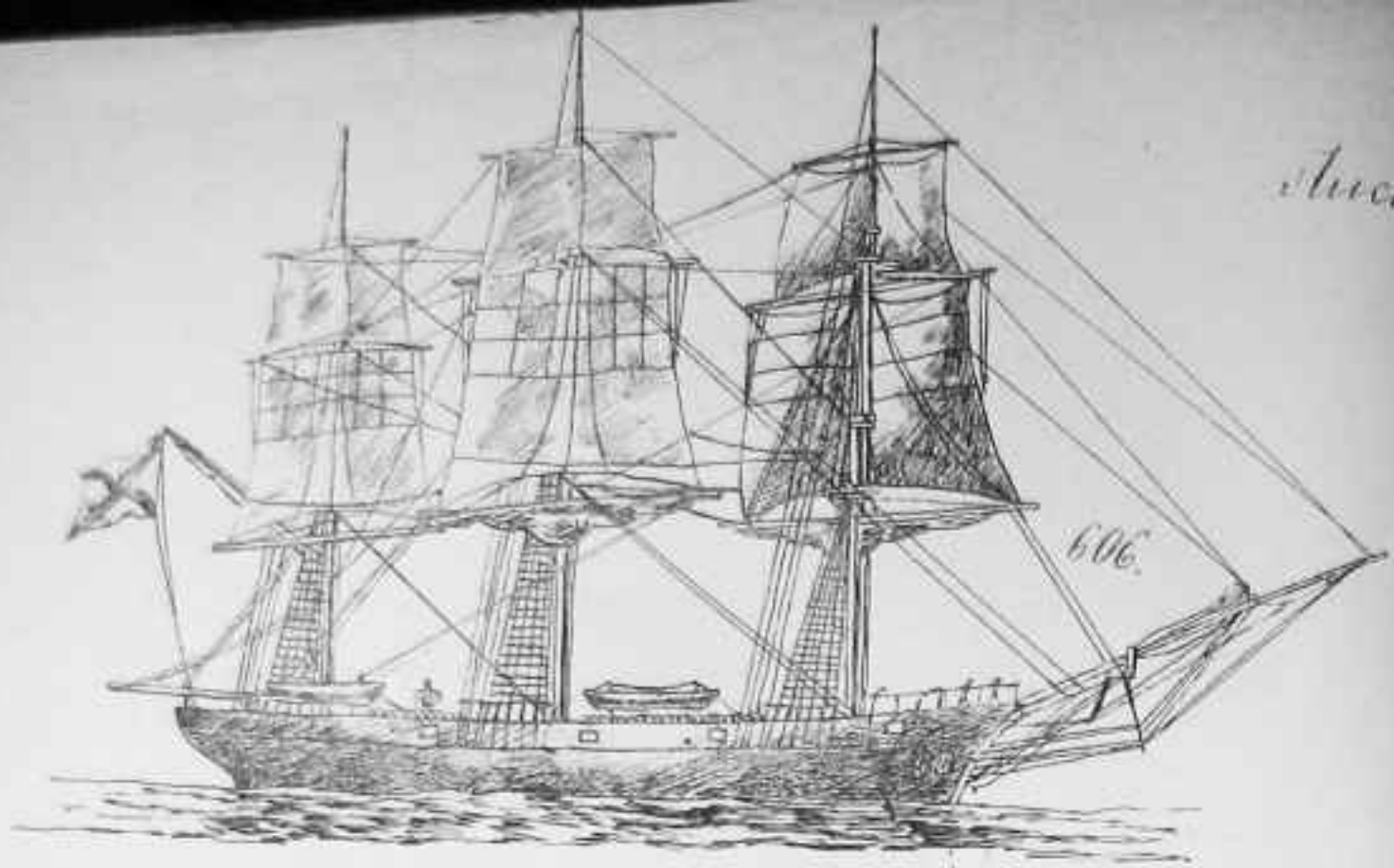

View from the foremast

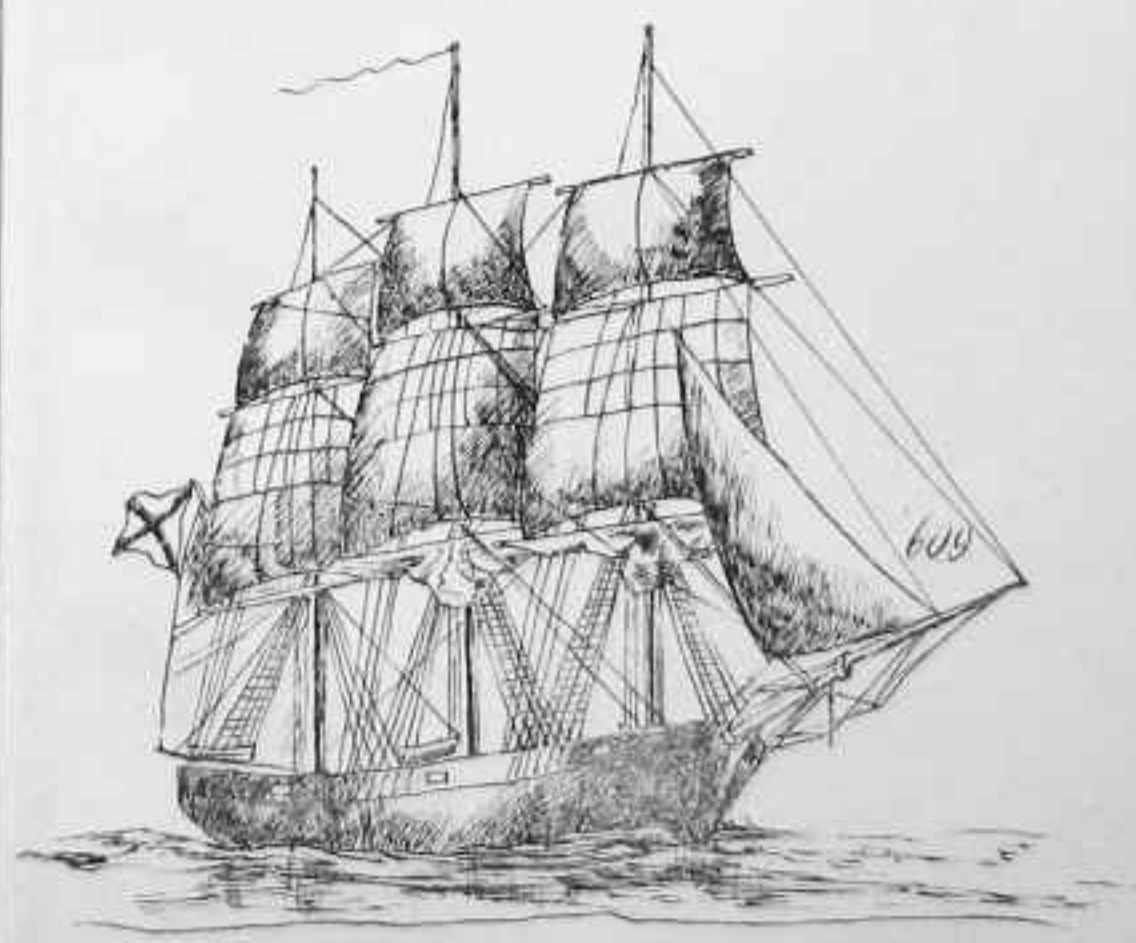

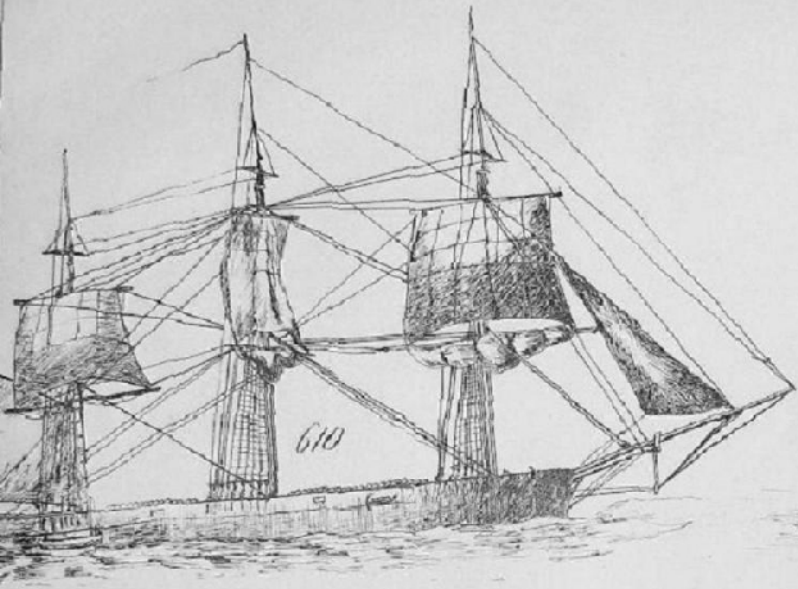

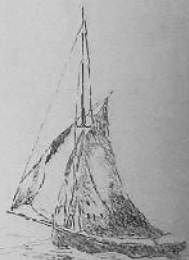
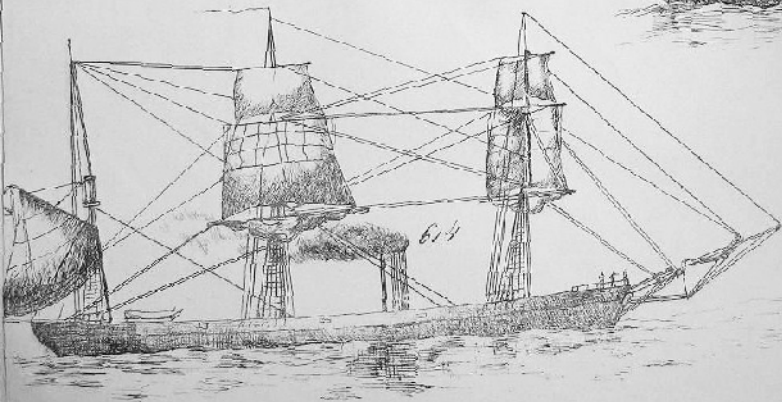
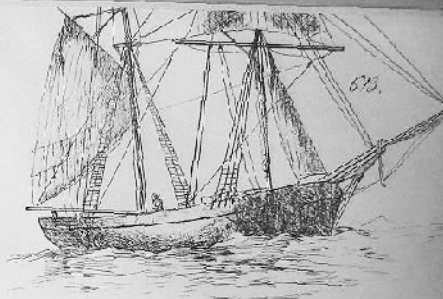
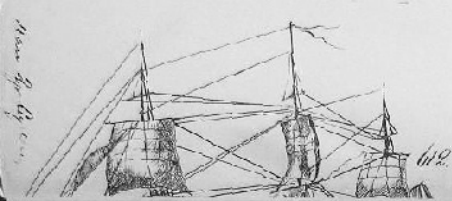

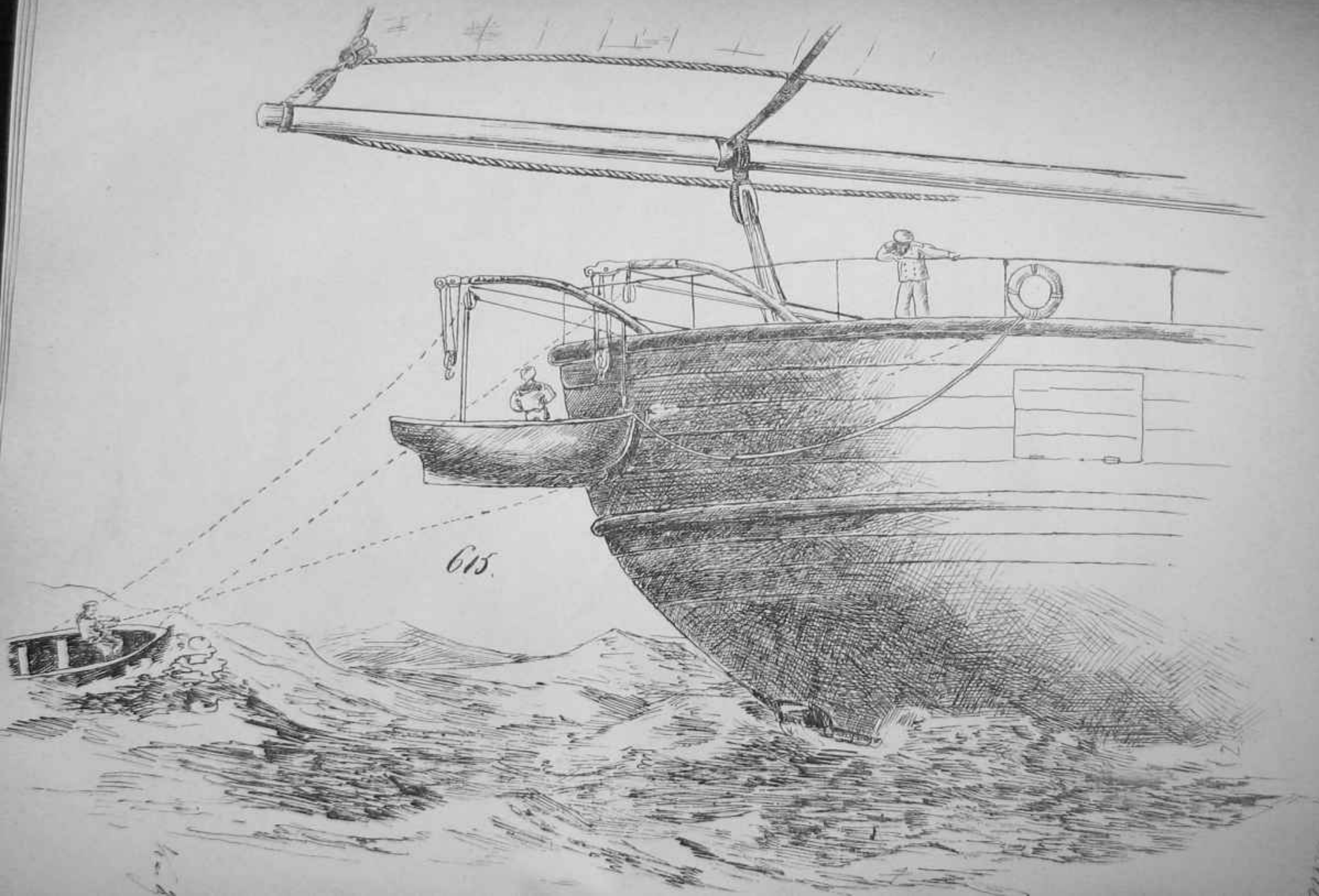

615.

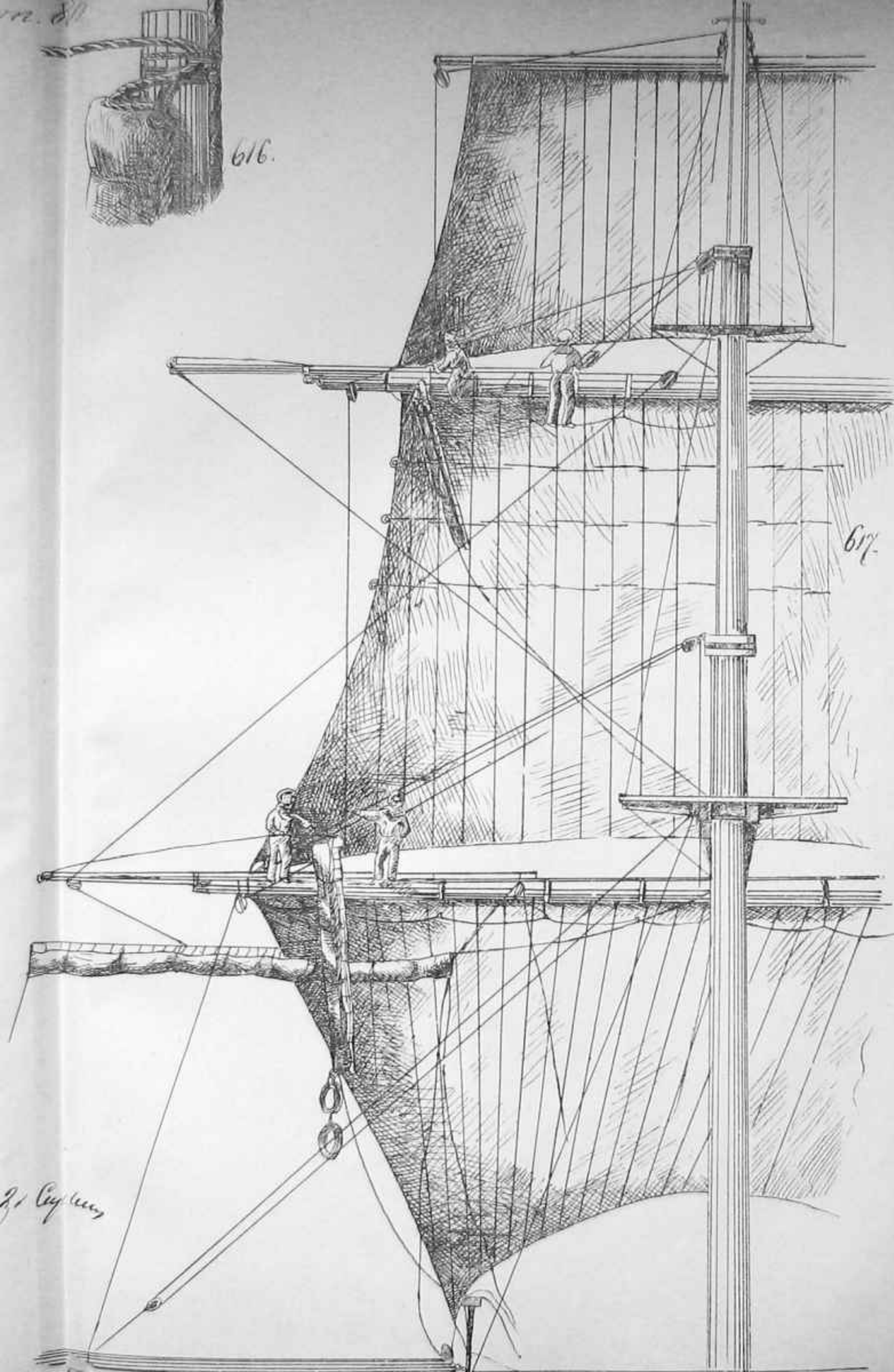

616.

617.

J. C. C. C.

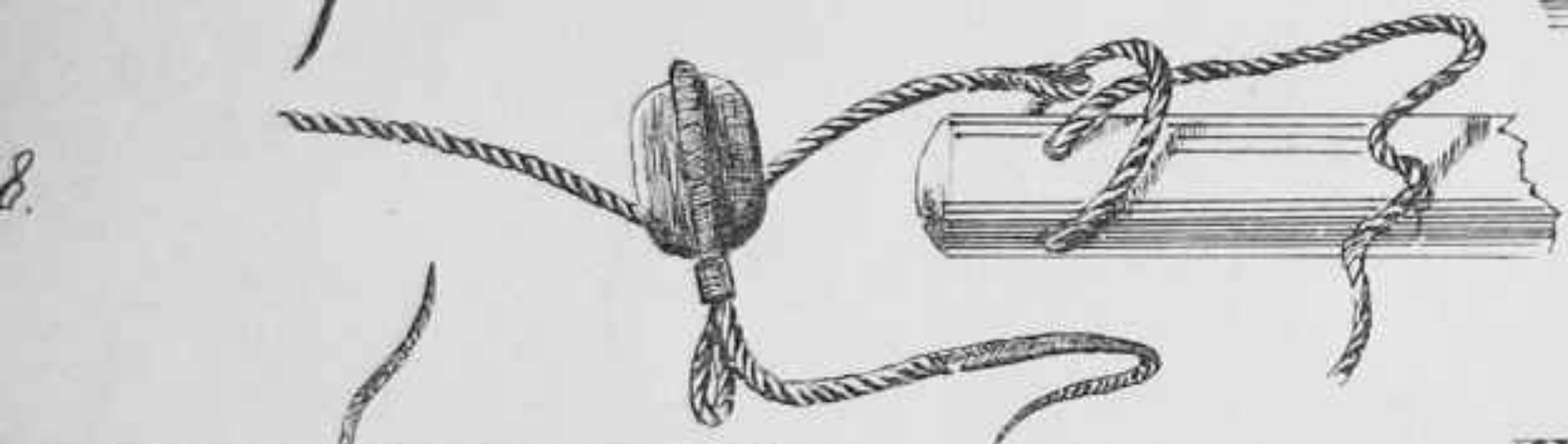
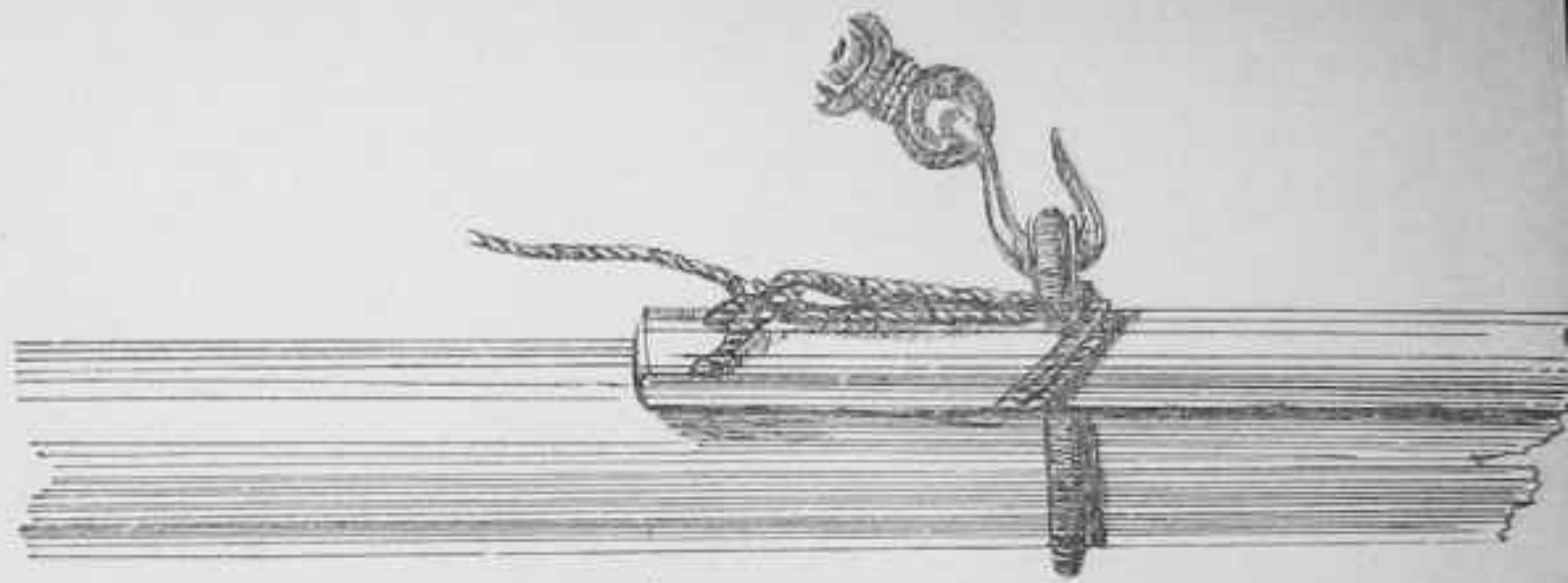
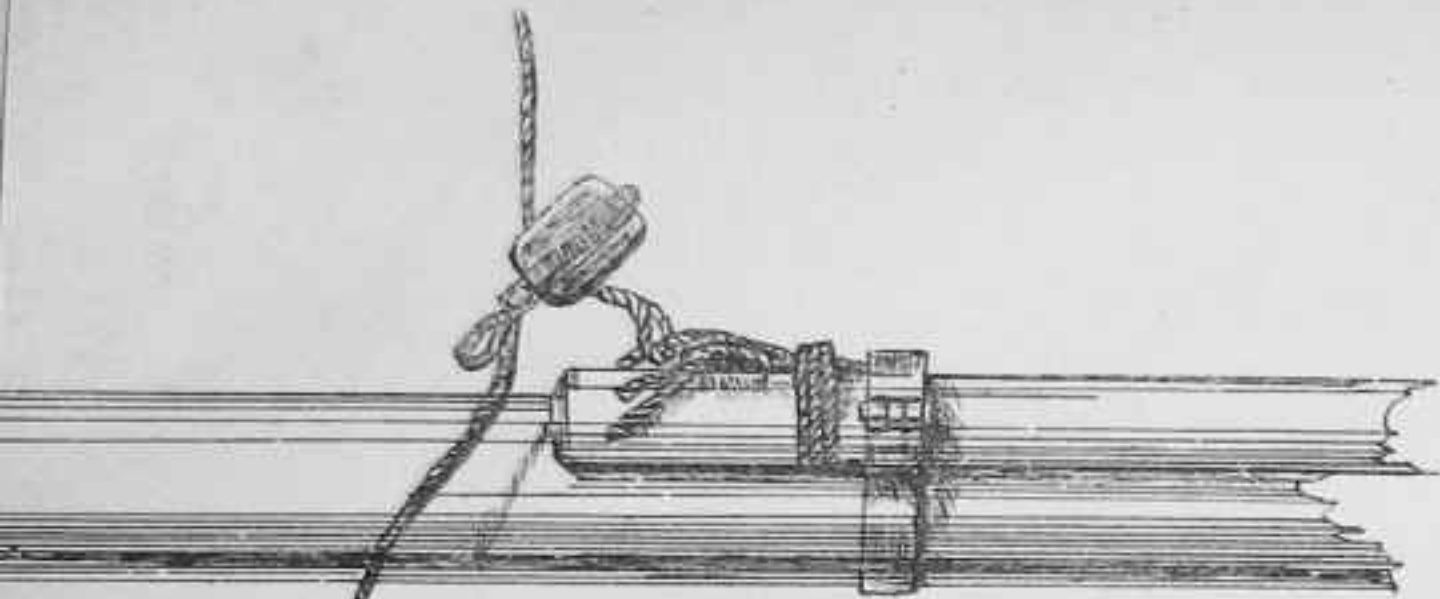

} 619.

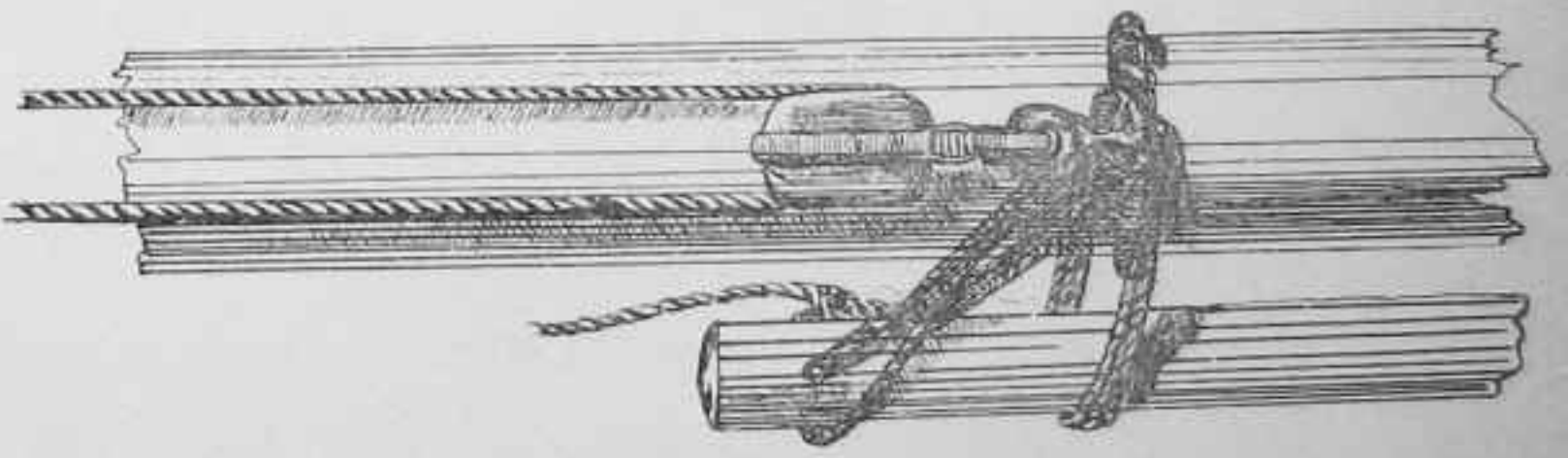
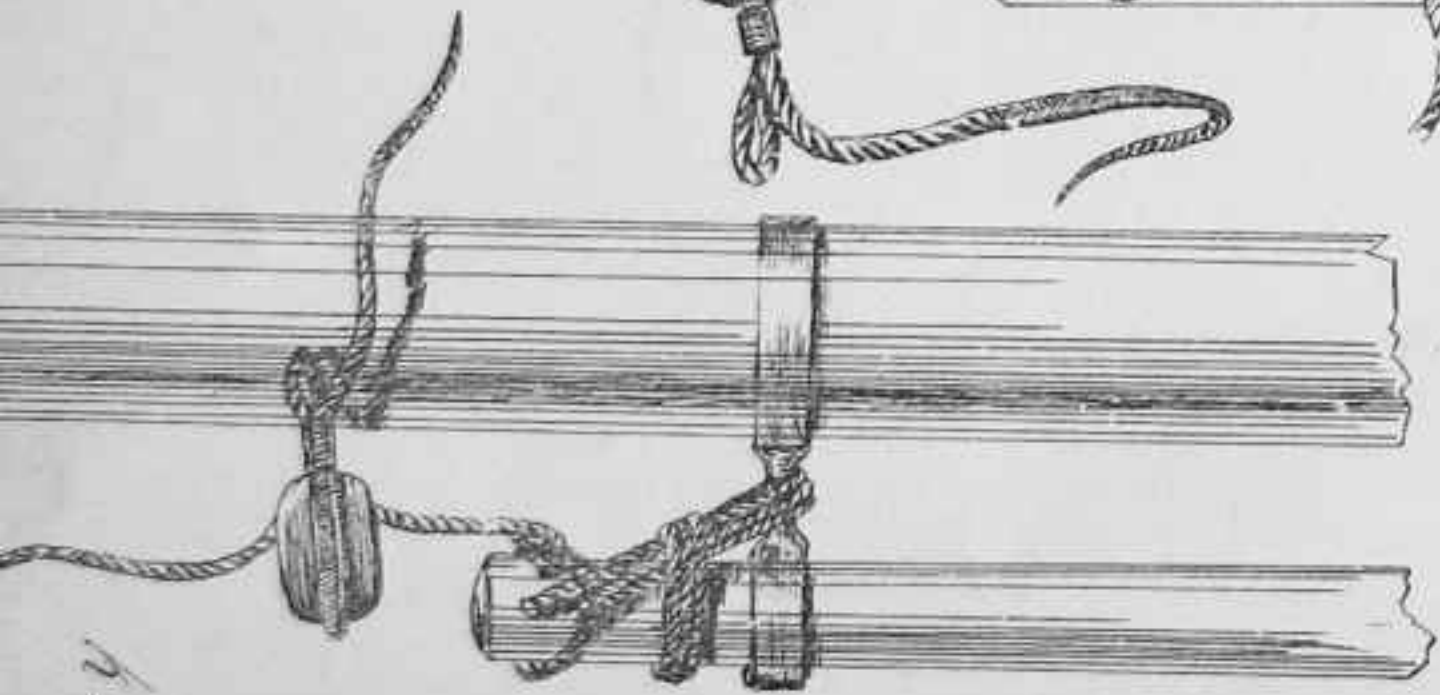

Lucas. No. 619.

Lucas. No. 619.

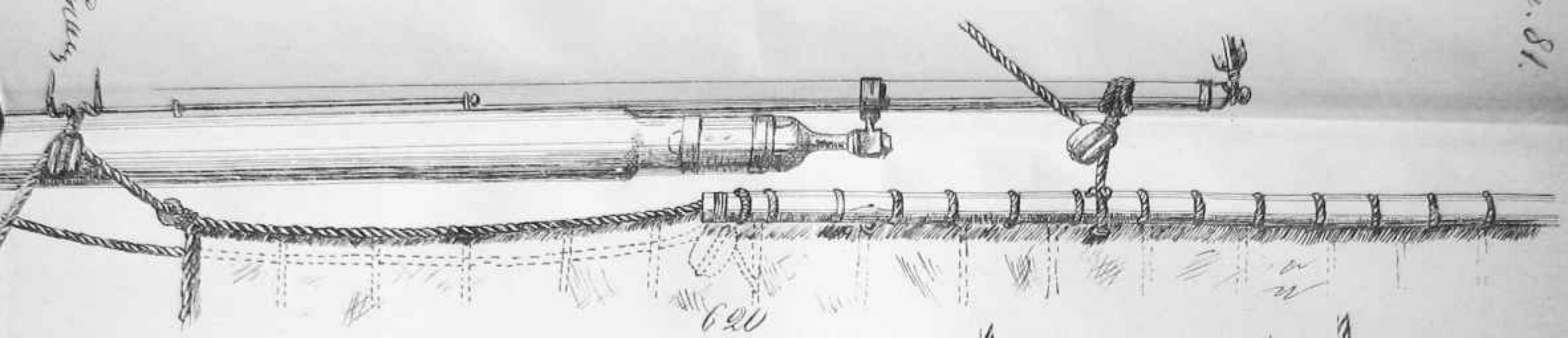

620

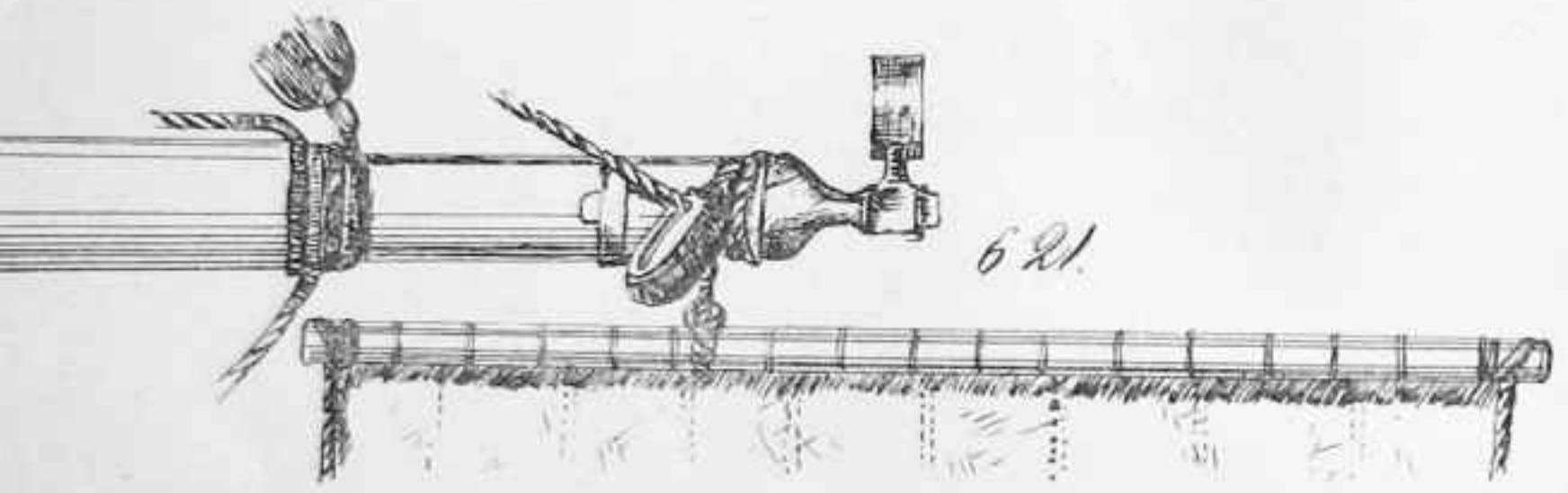

621



622

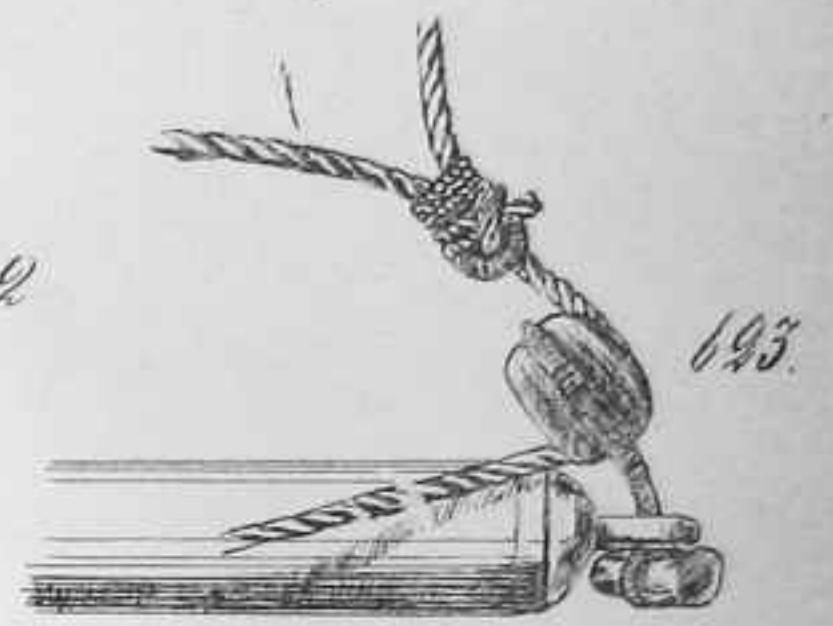

623

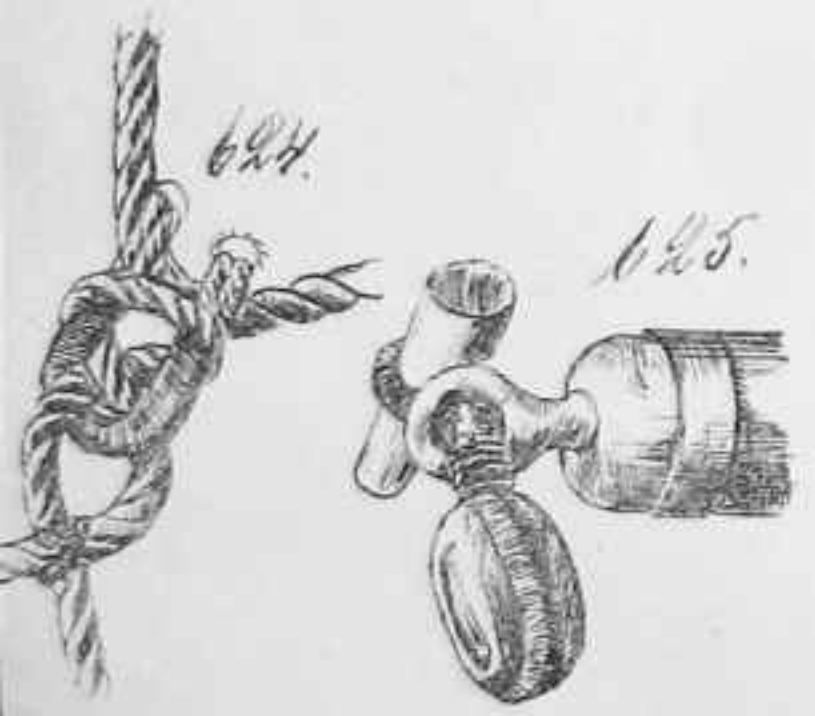

624



625

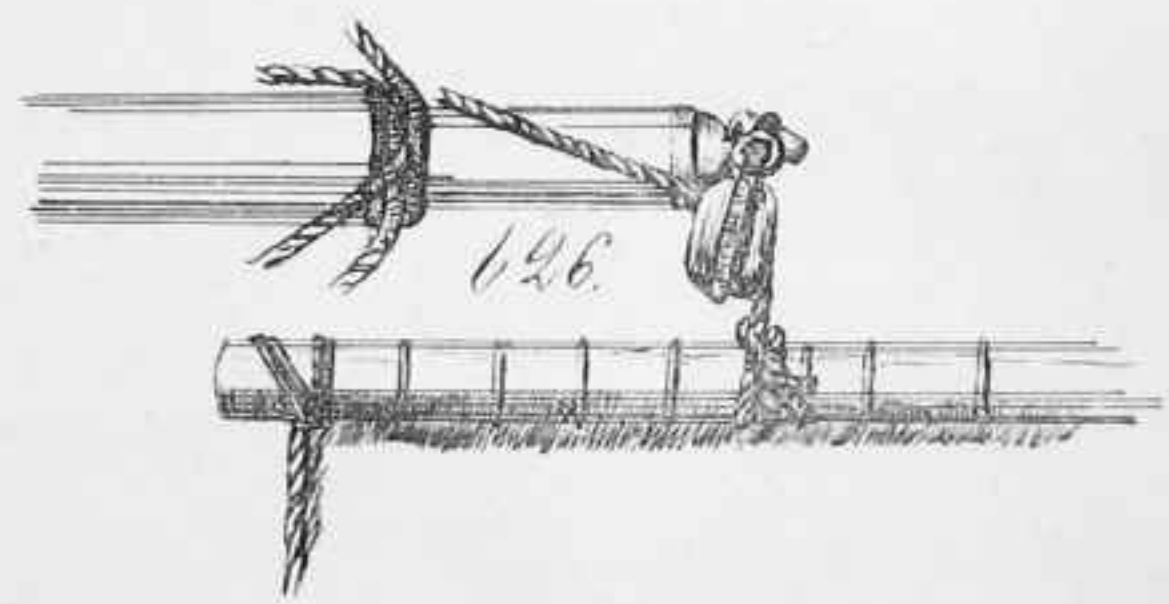

626

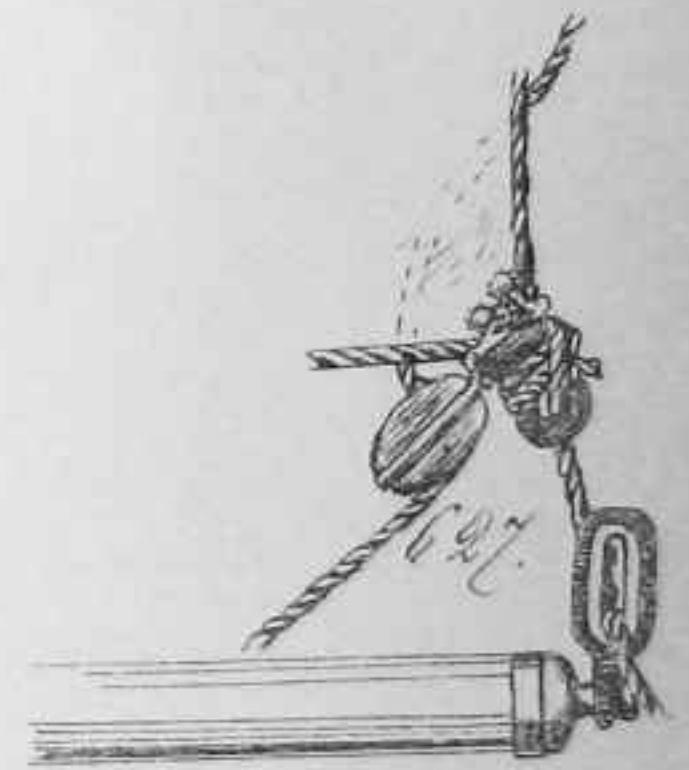

627

Турец. 82



698

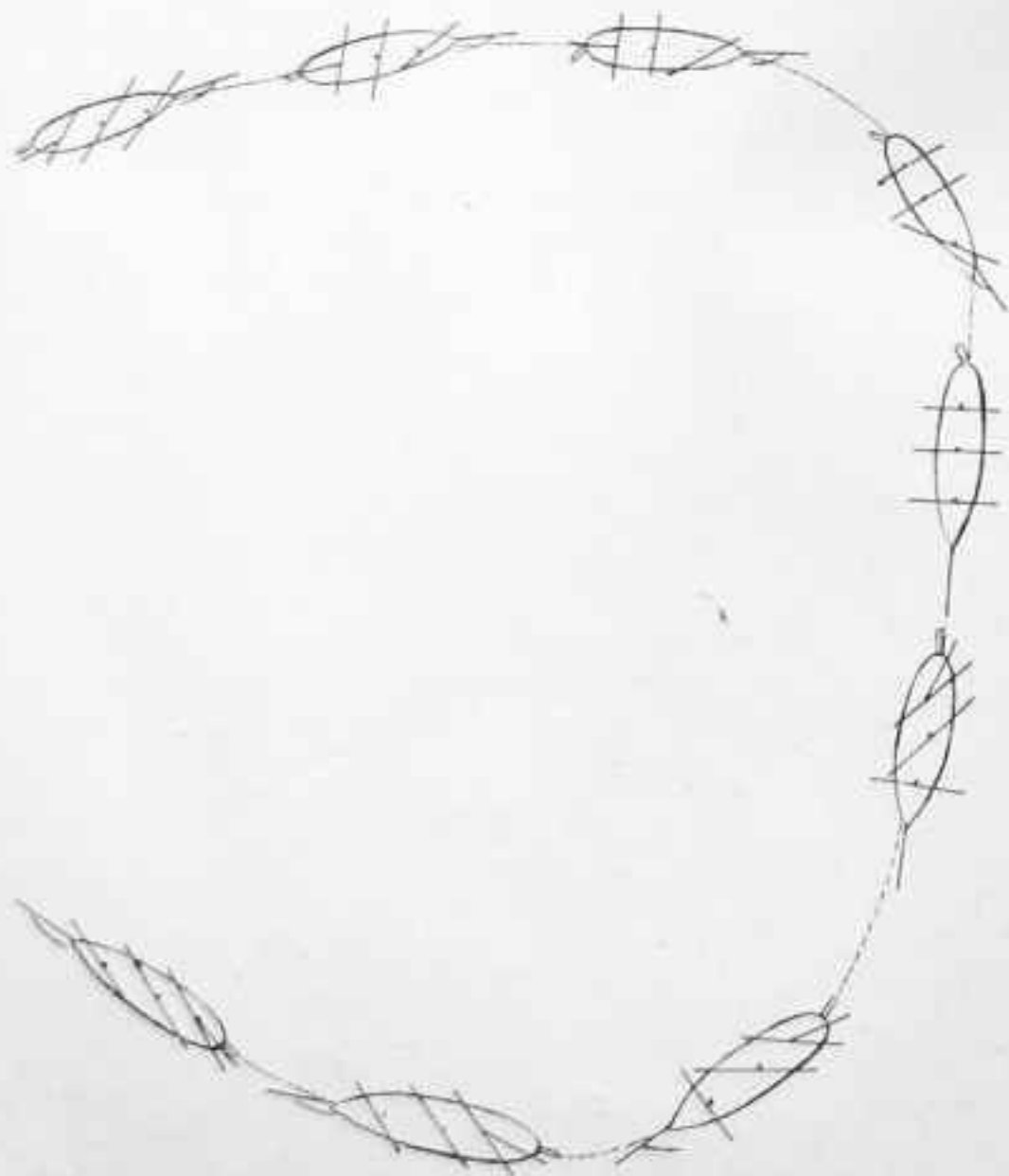

суды Коплан



699

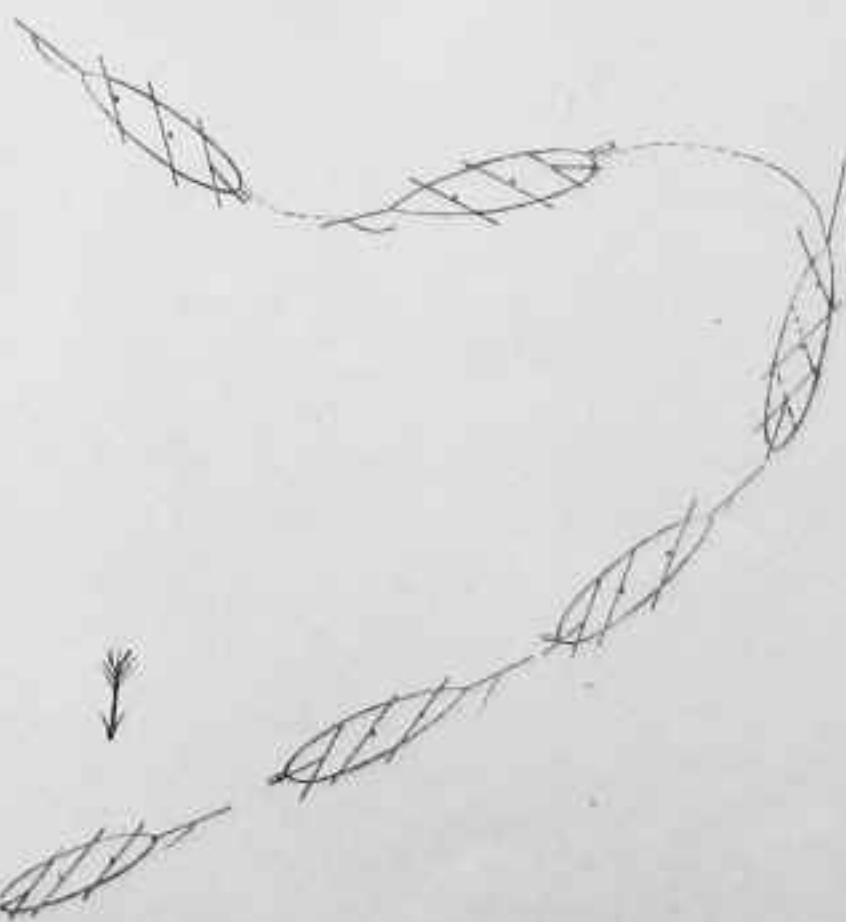

Lucas 83.



630



631

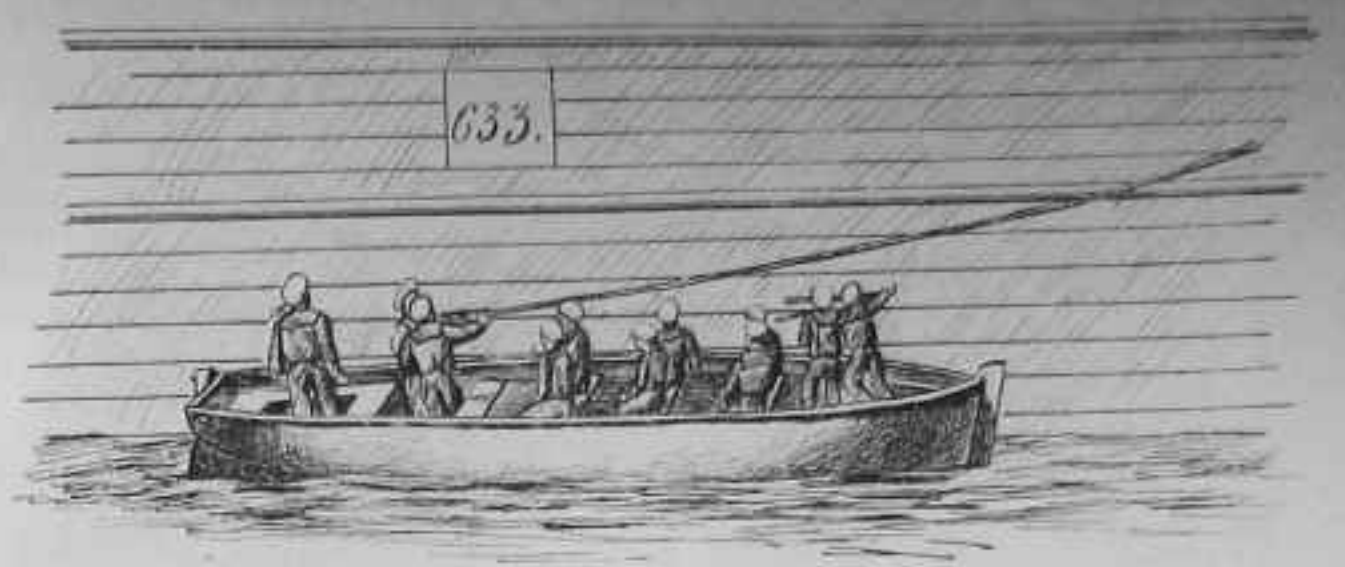

633



632

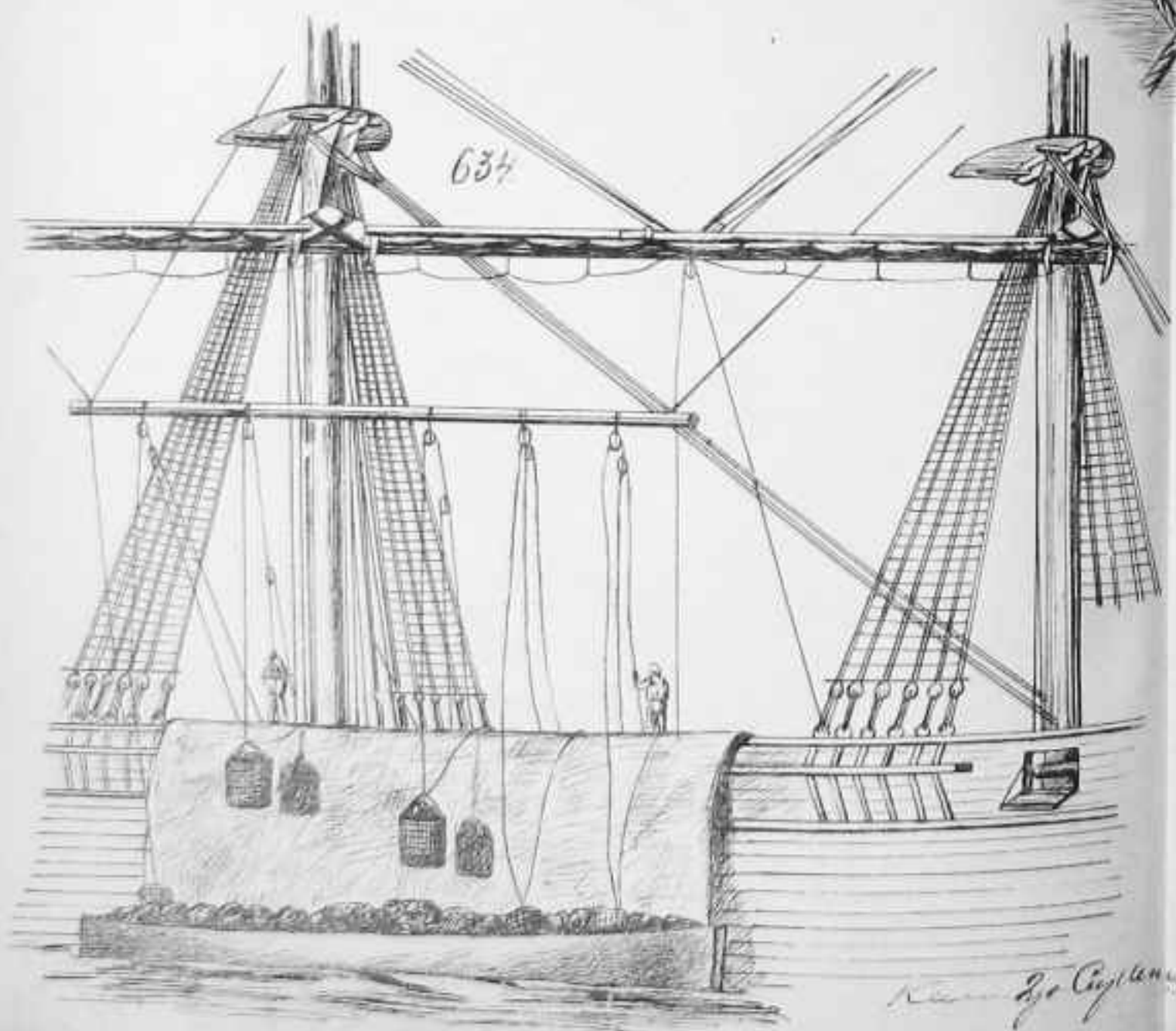

634

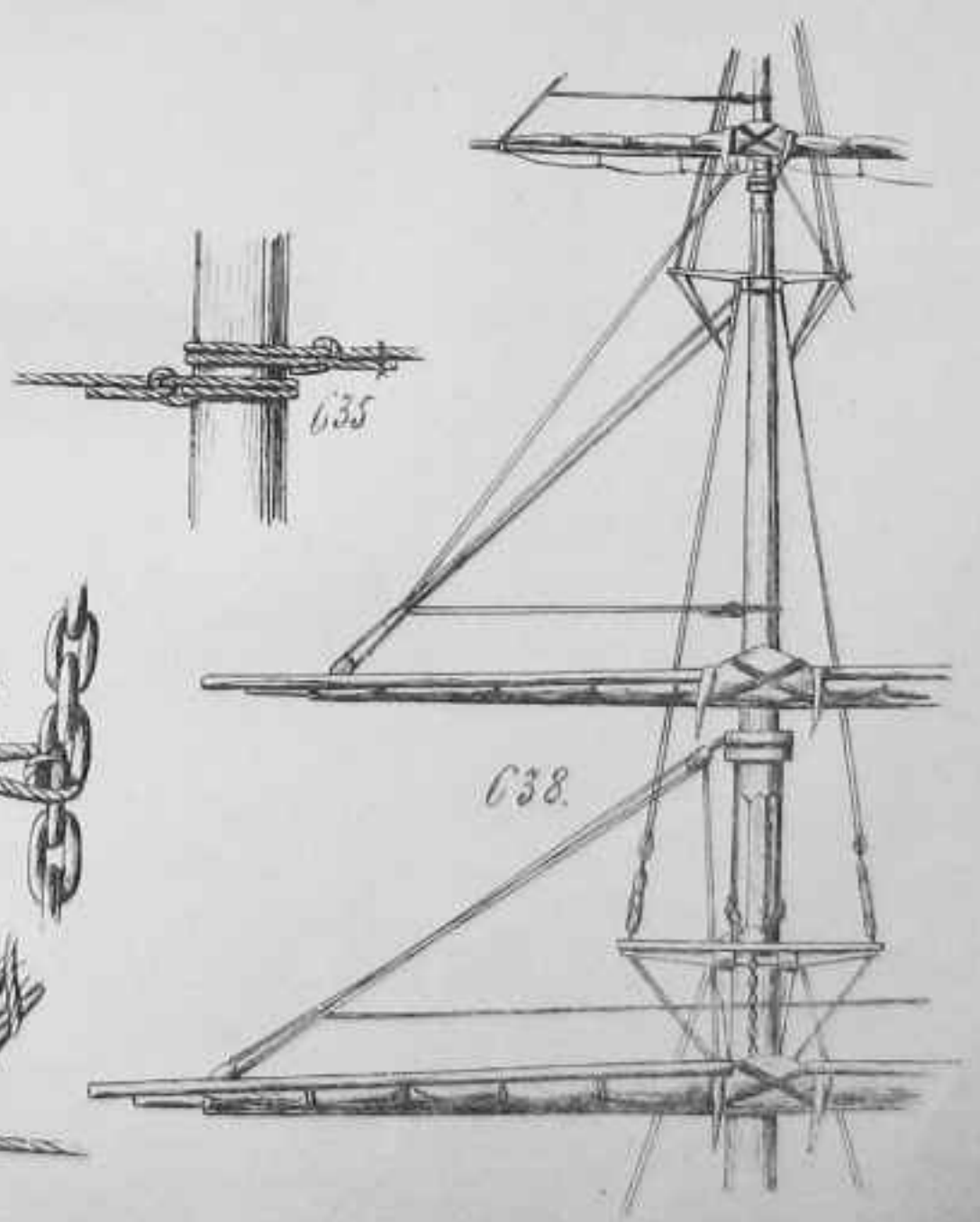

635

638



636



637

New York City



Pl. 84.

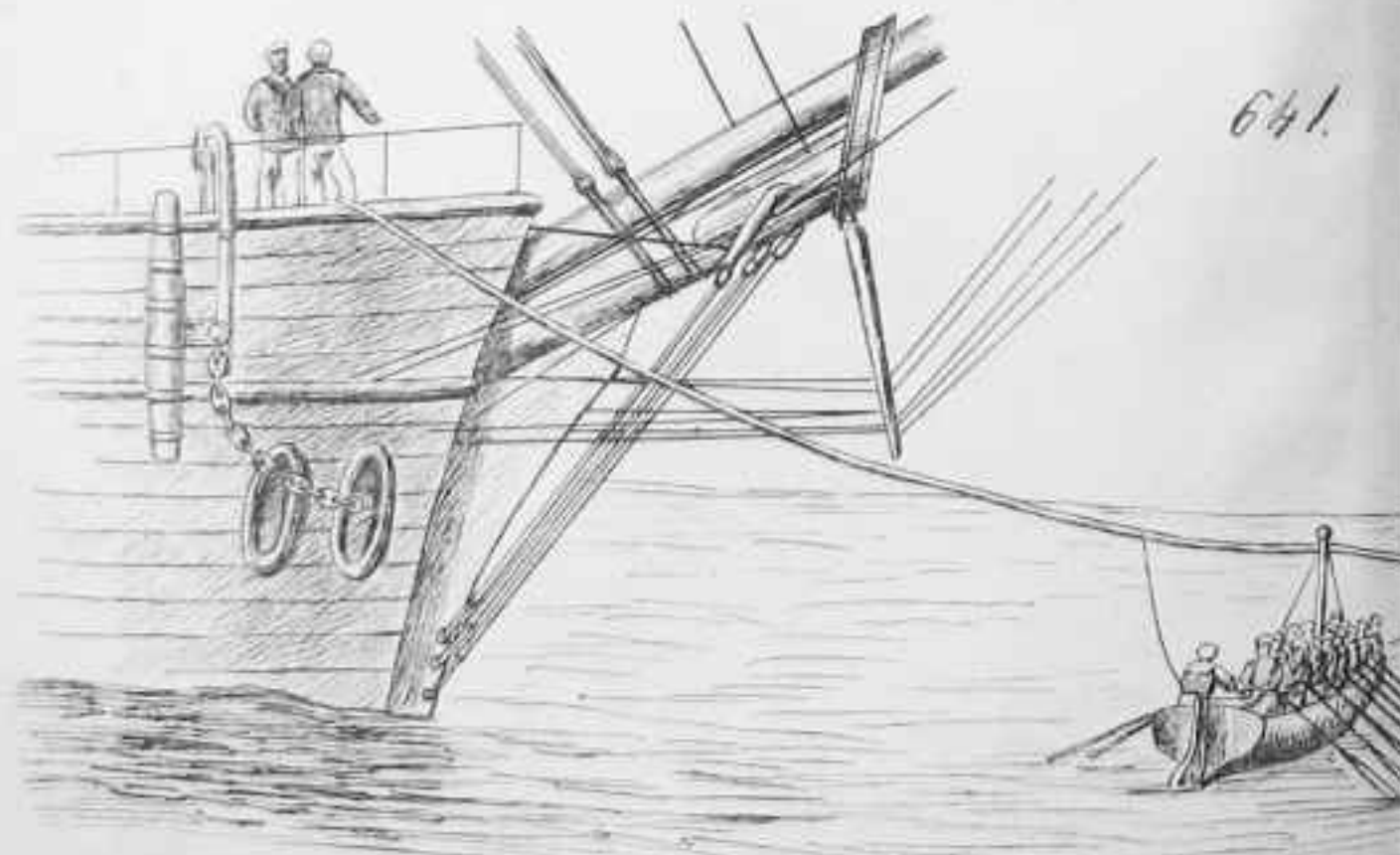
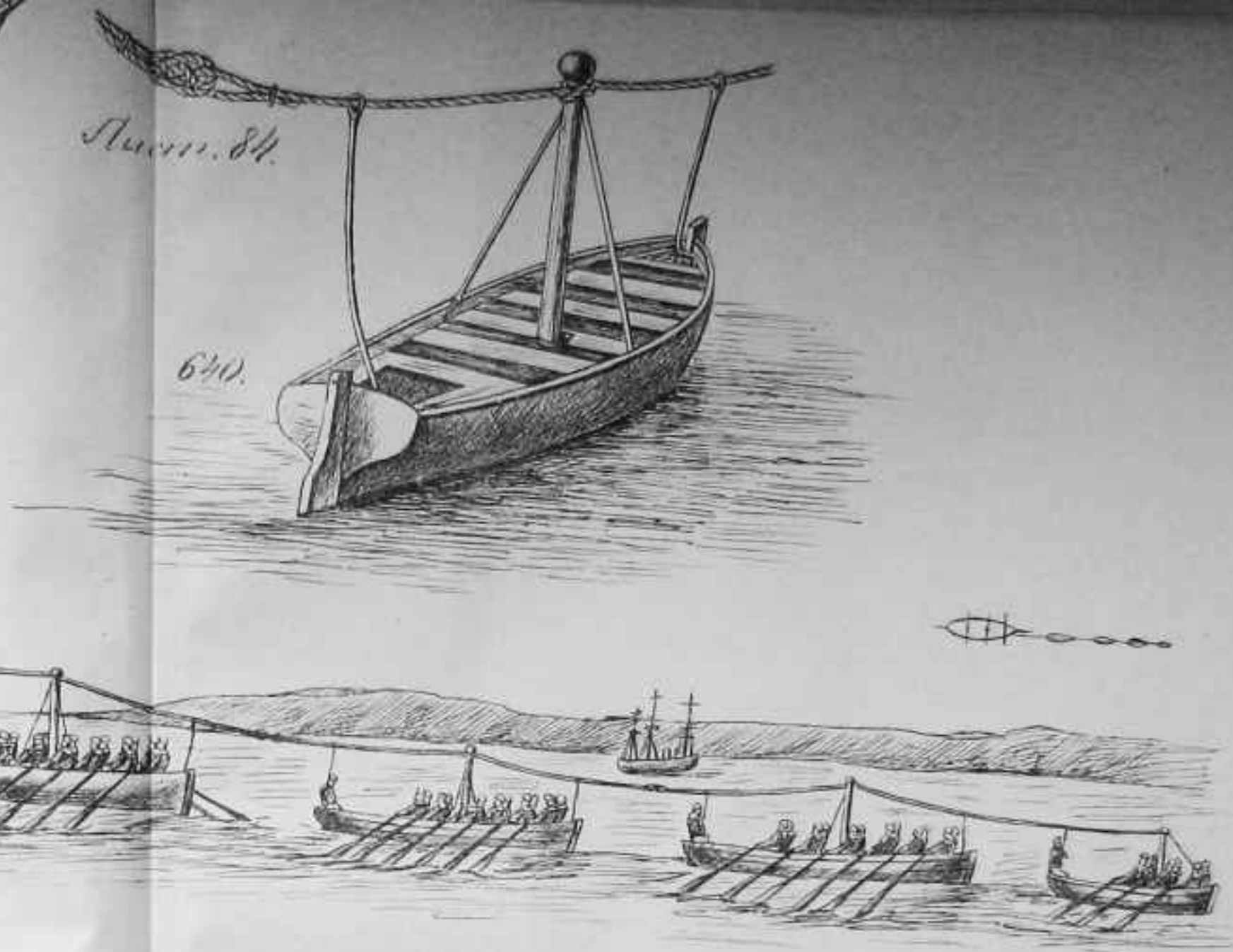

van Gylpen

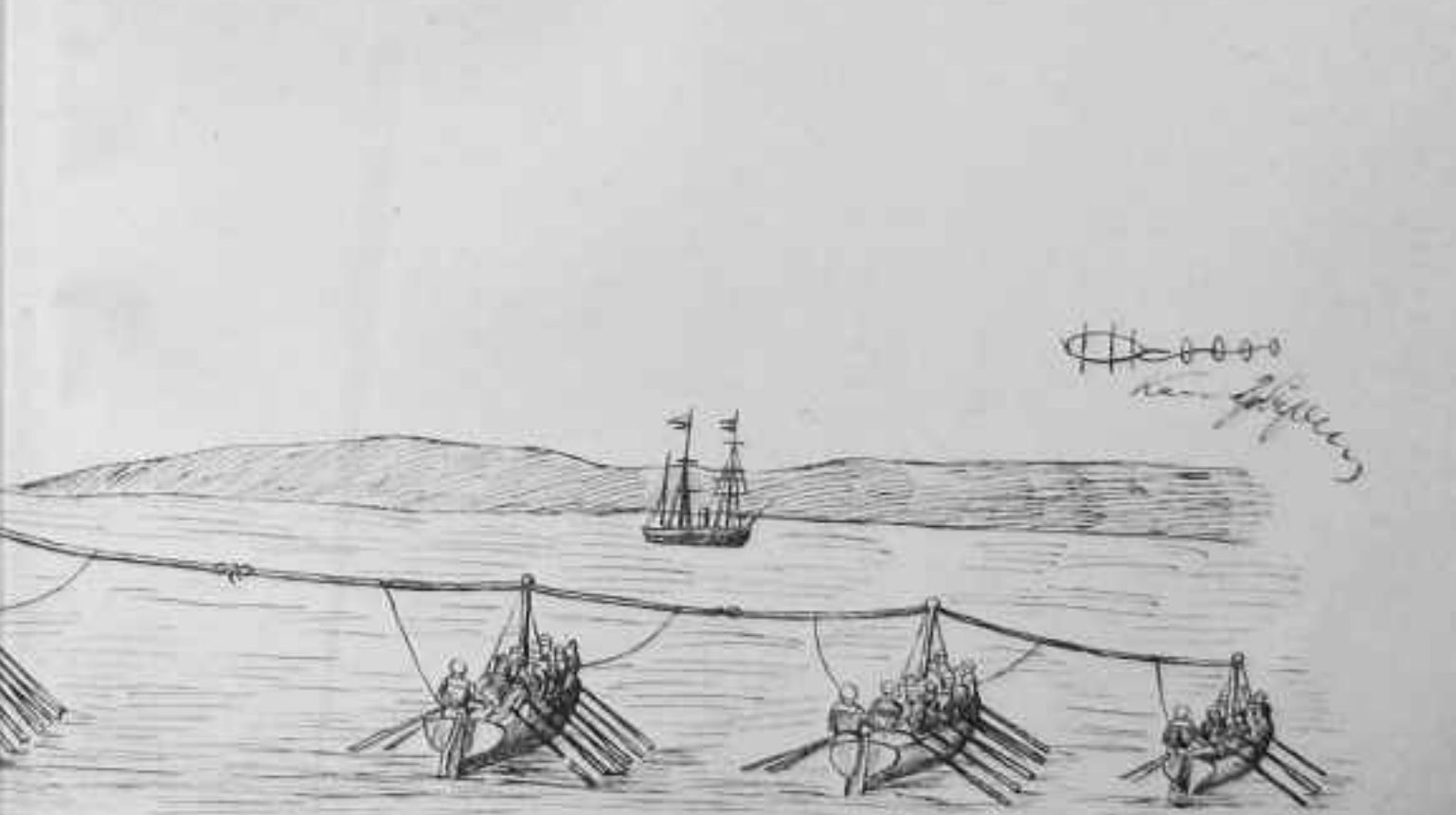



Lucia 30

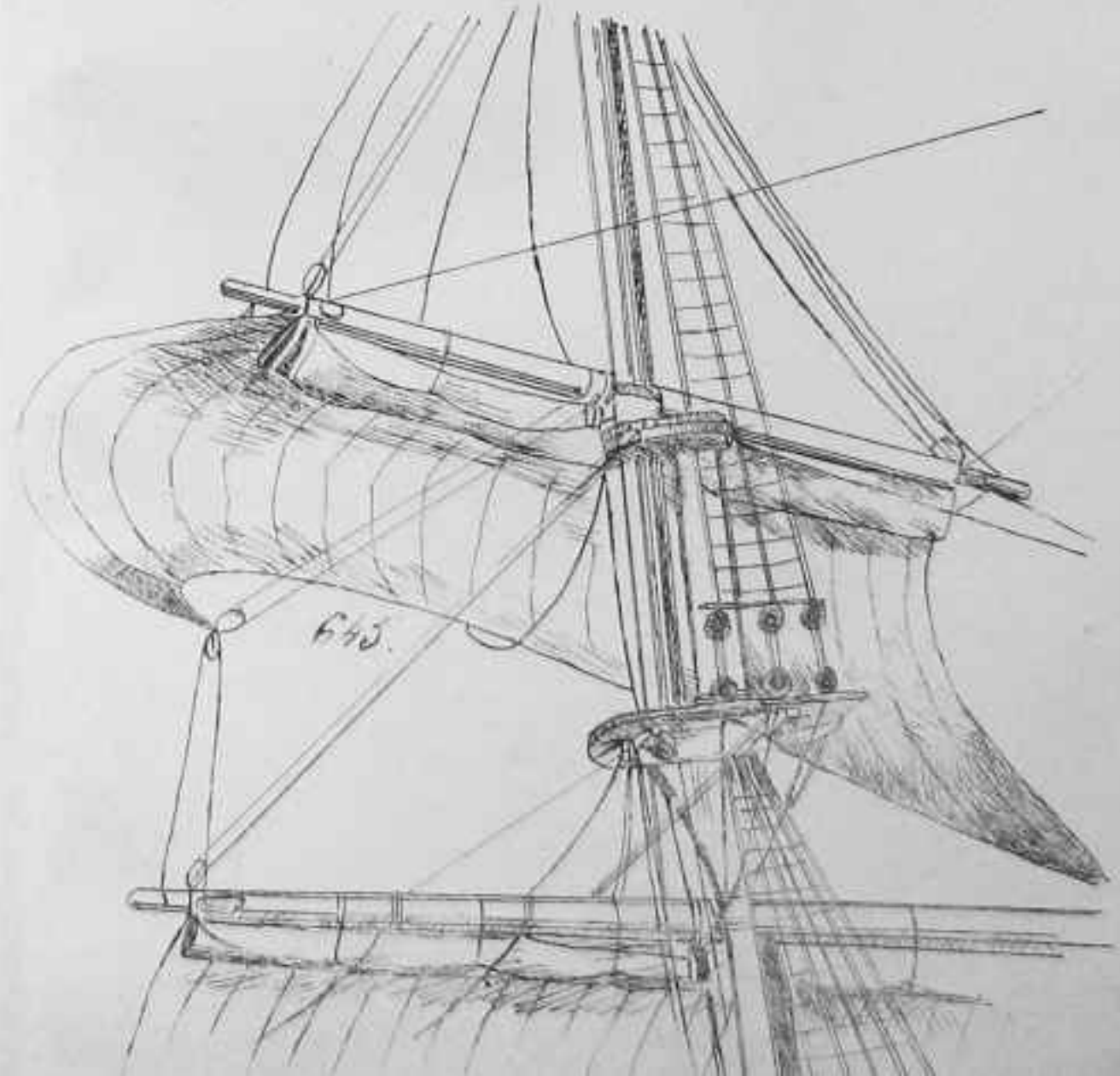

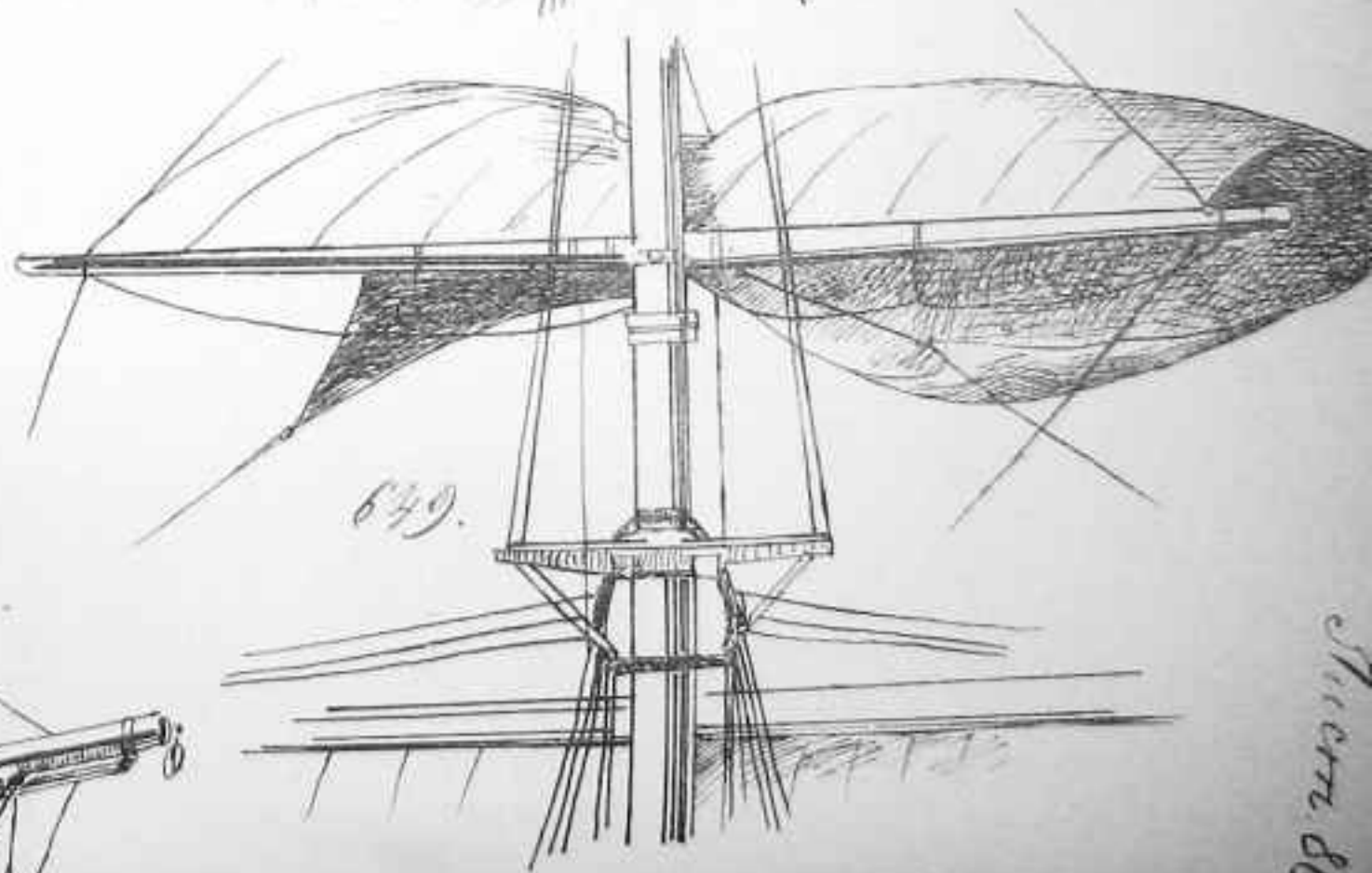
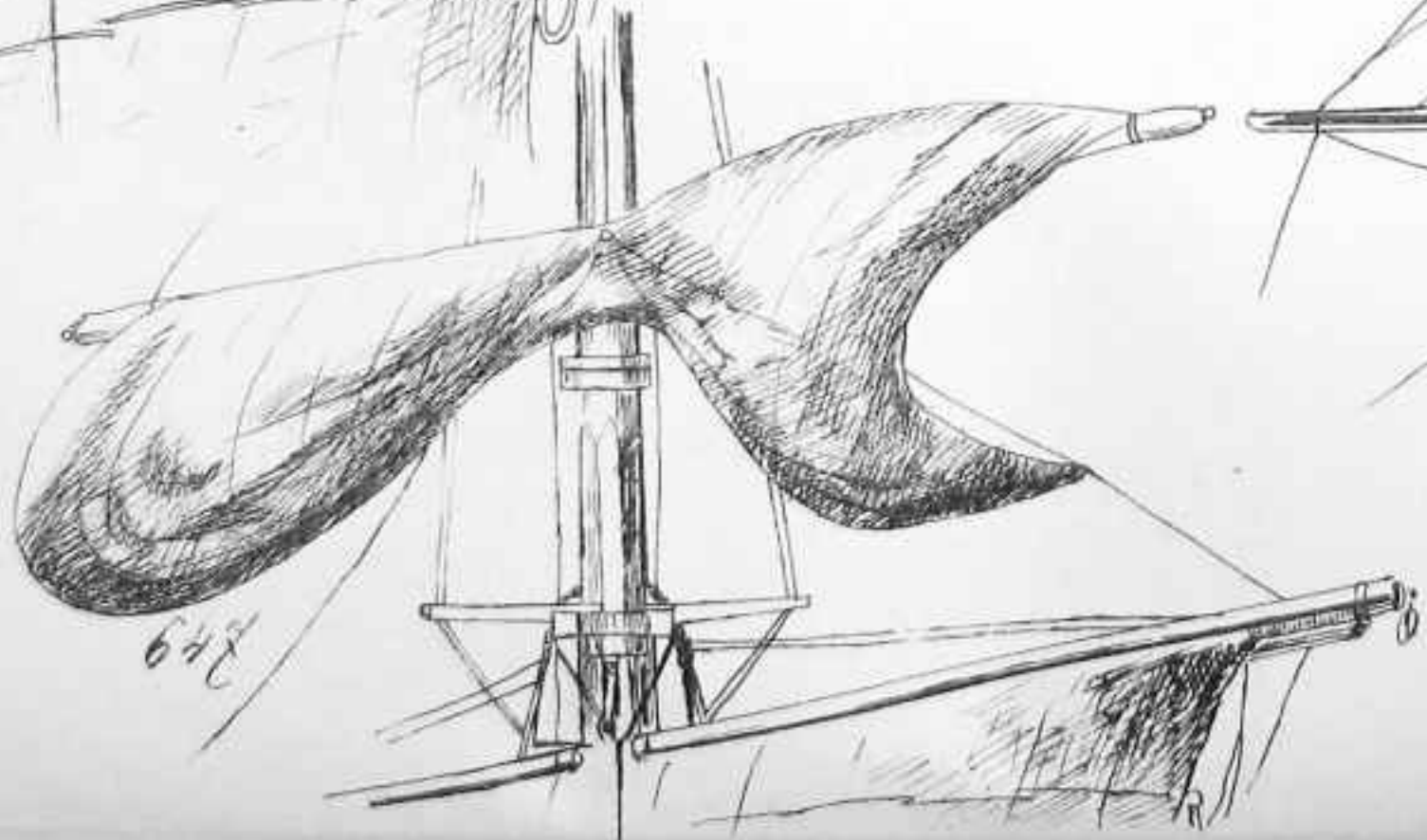
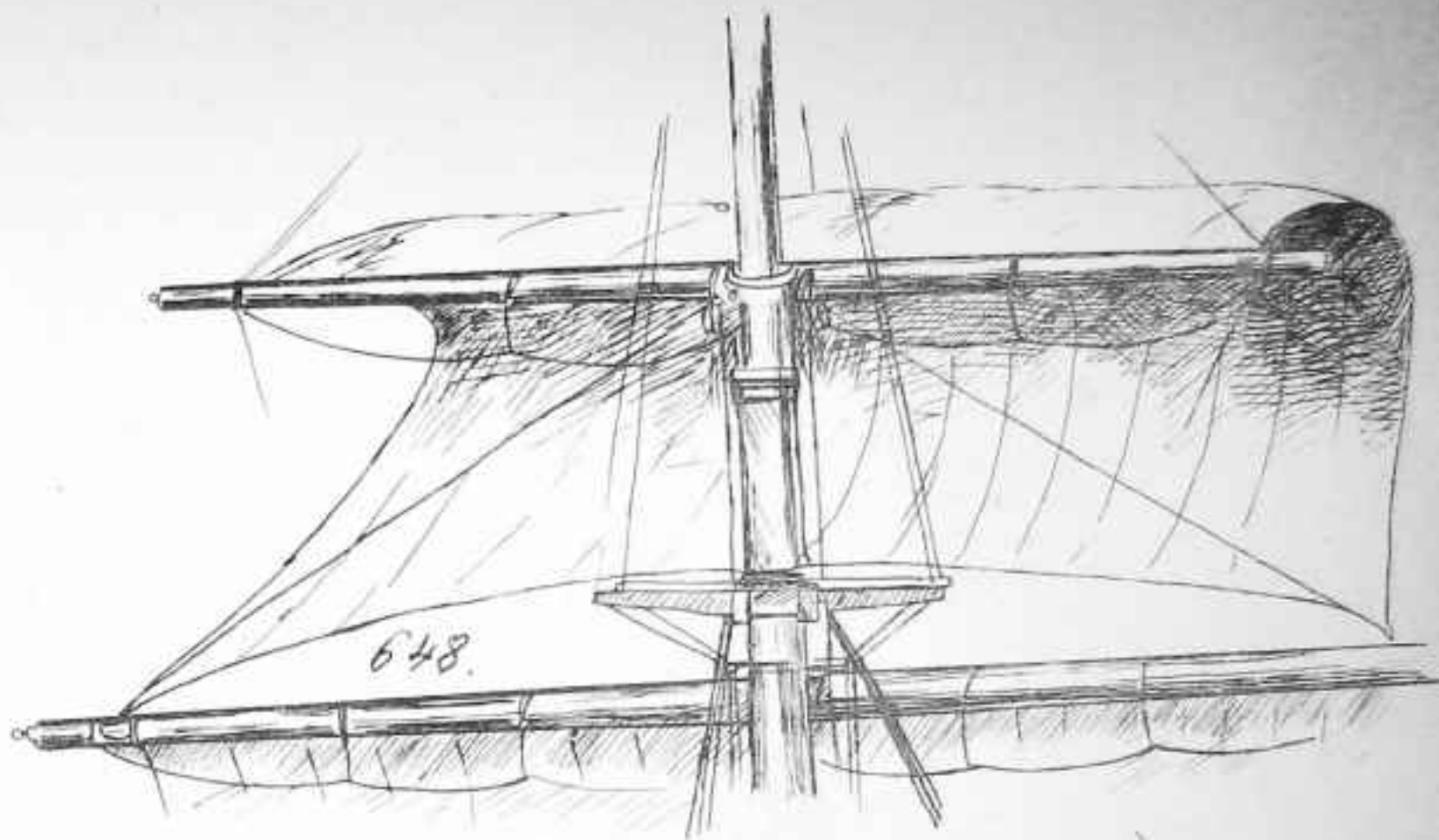

Spinnaker

Sheet 86

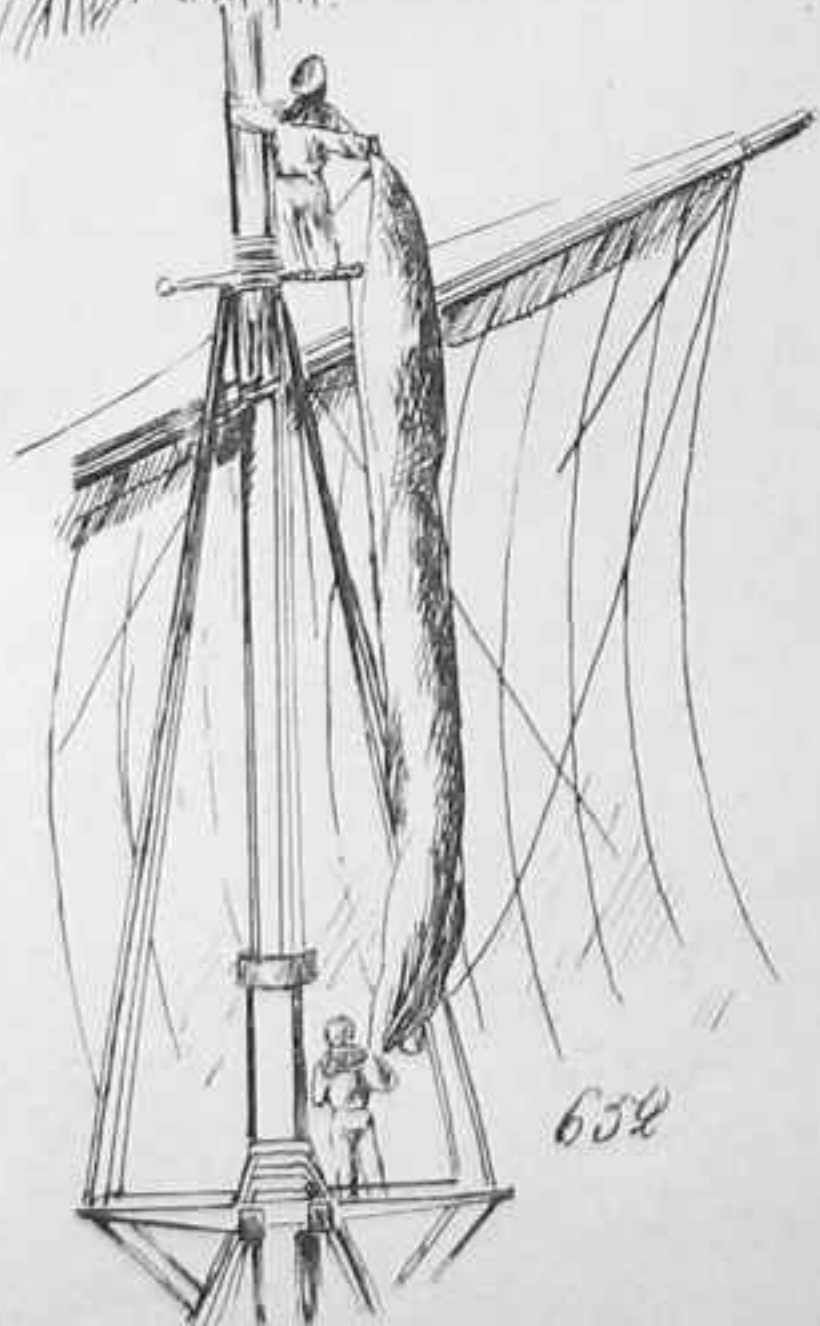
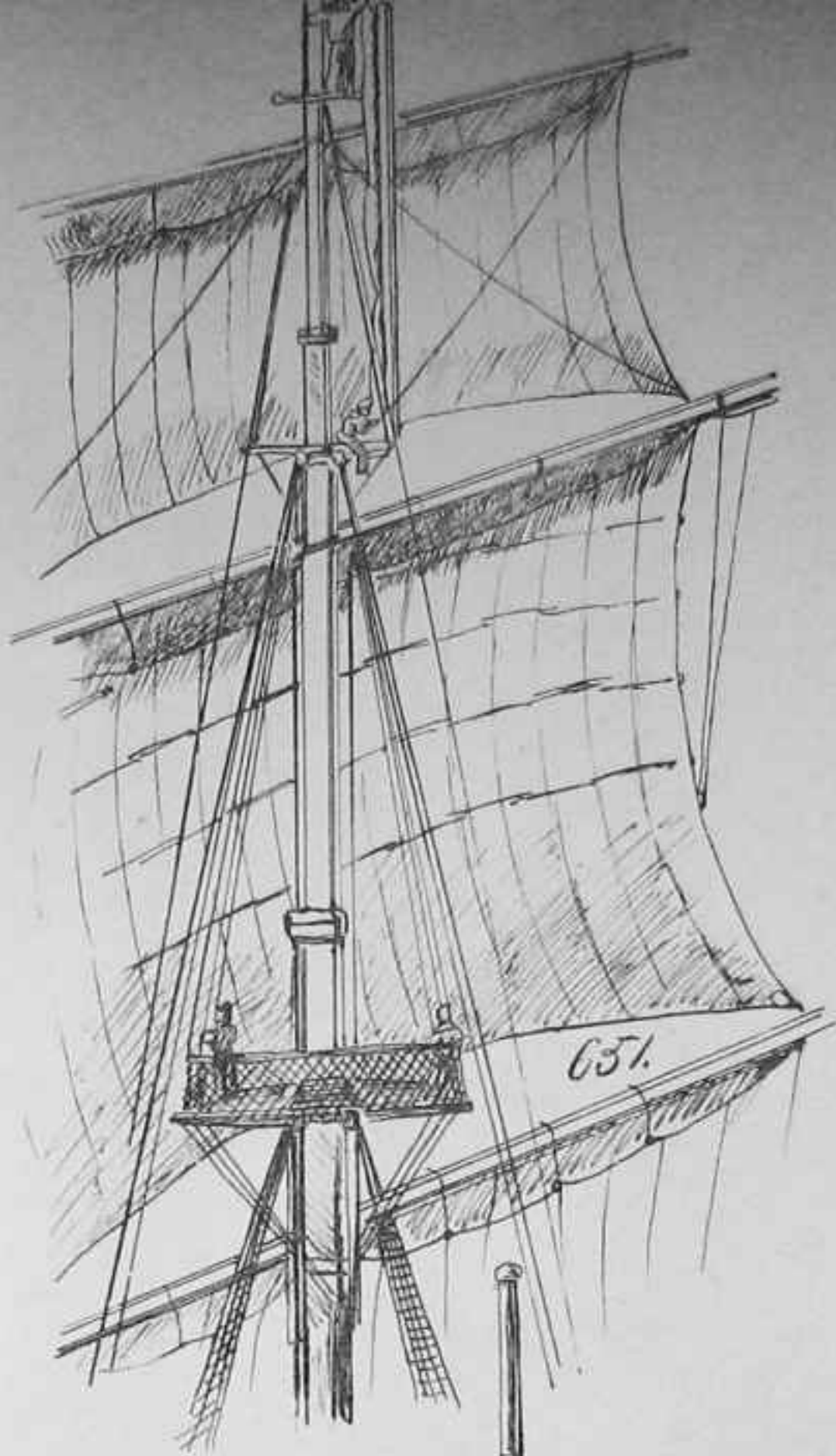
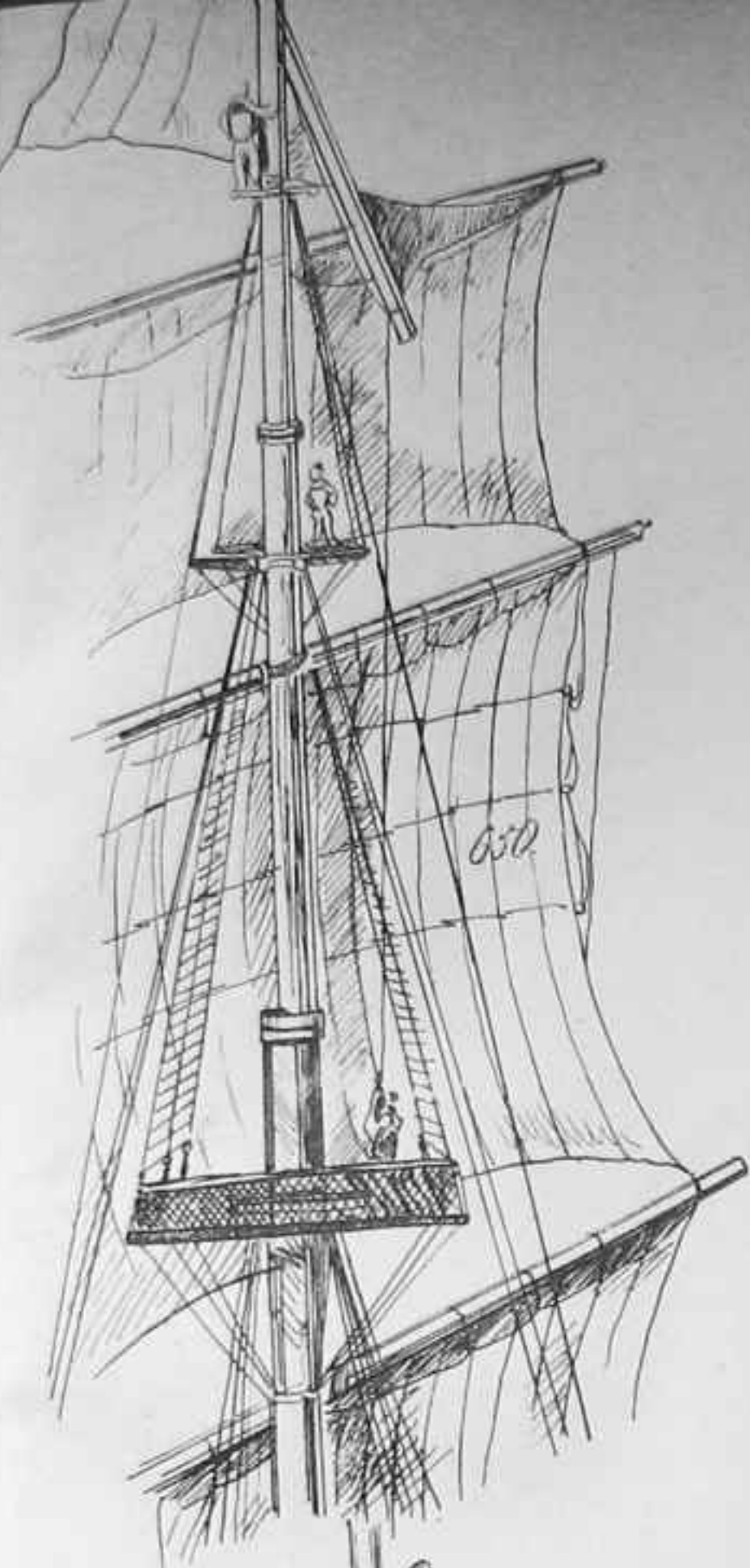

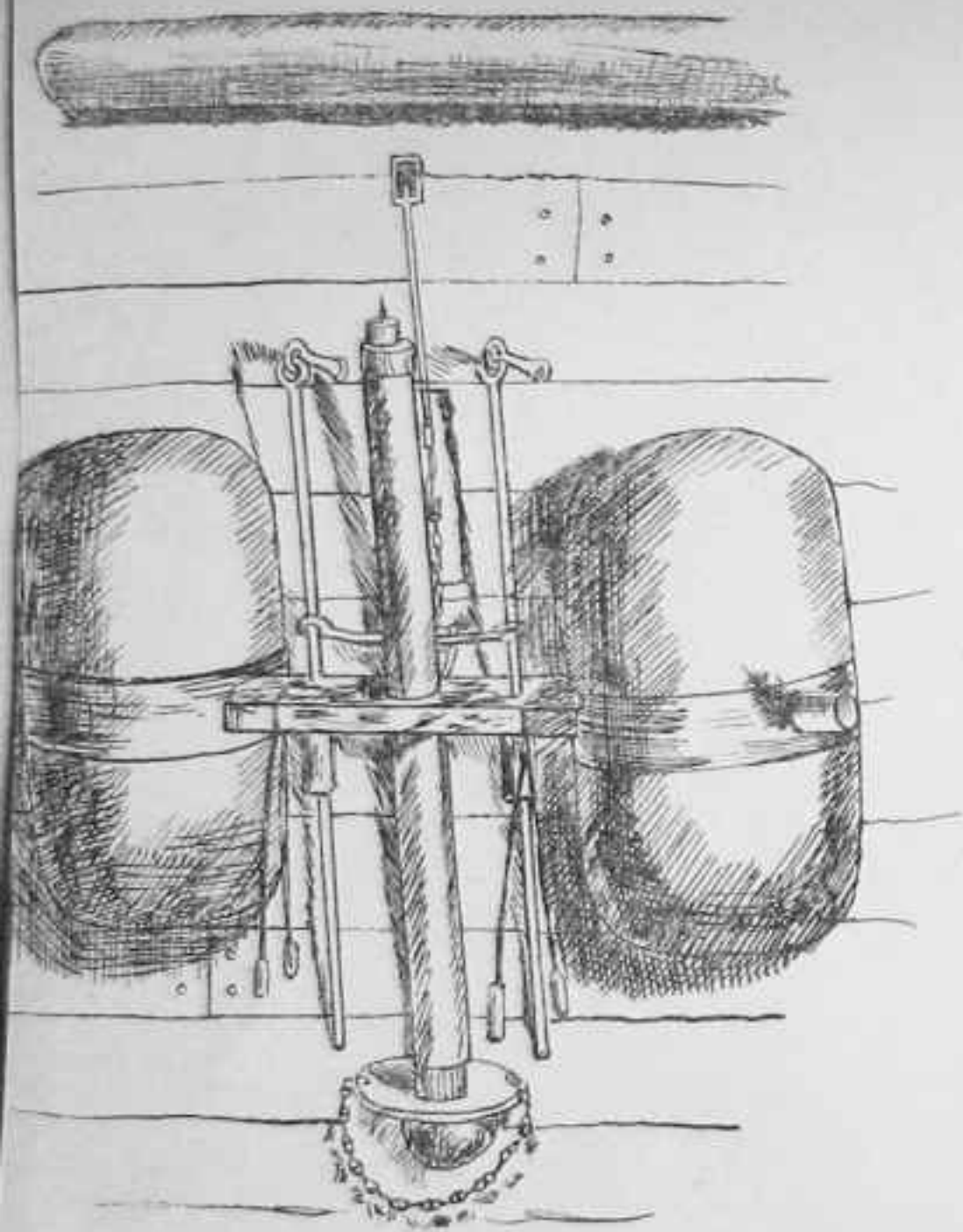

154.



Handwritten signature or name, possibly 'W. B. ...'

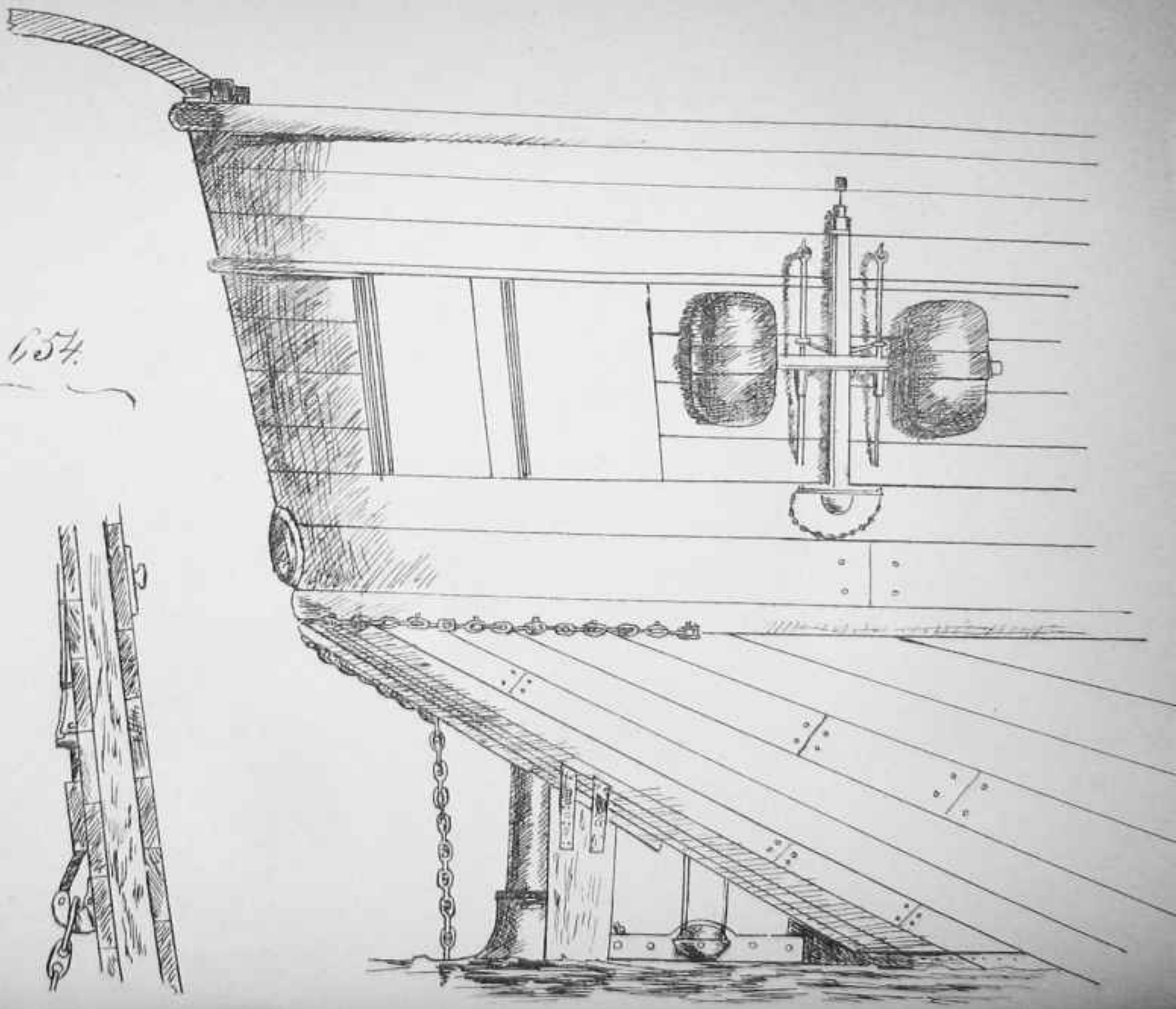
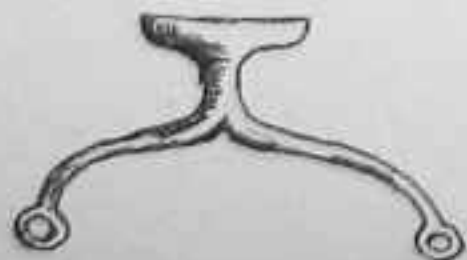

Handwritten initials or mark, possibly 'CM'

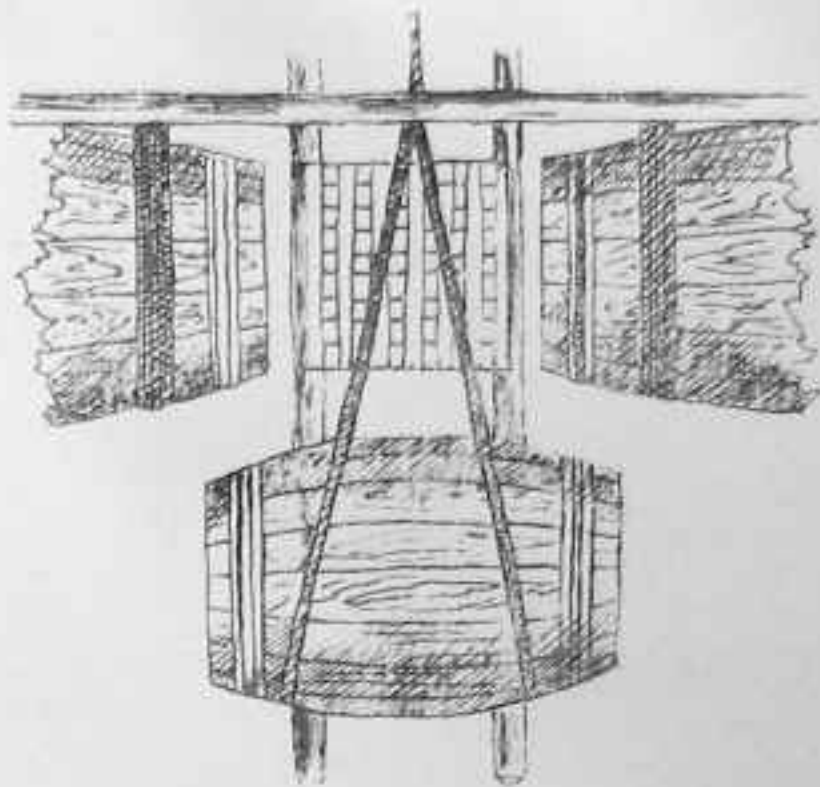
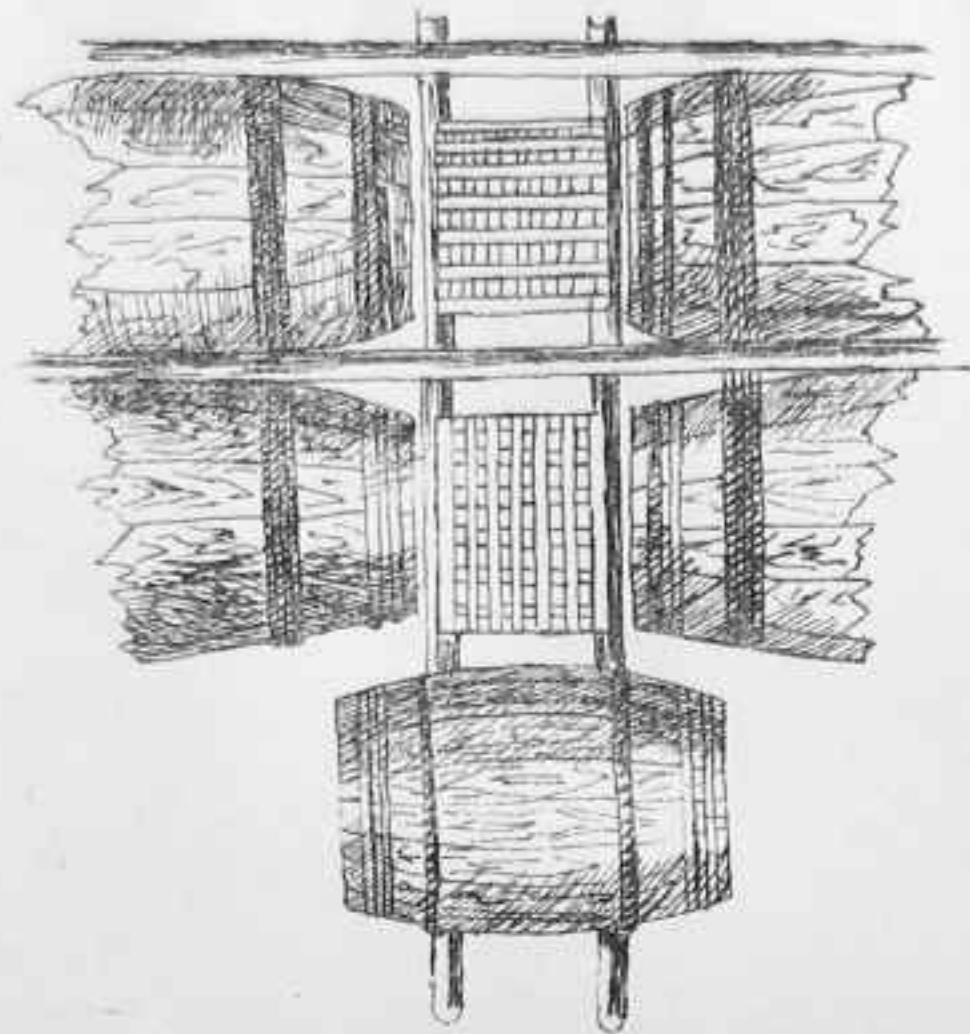
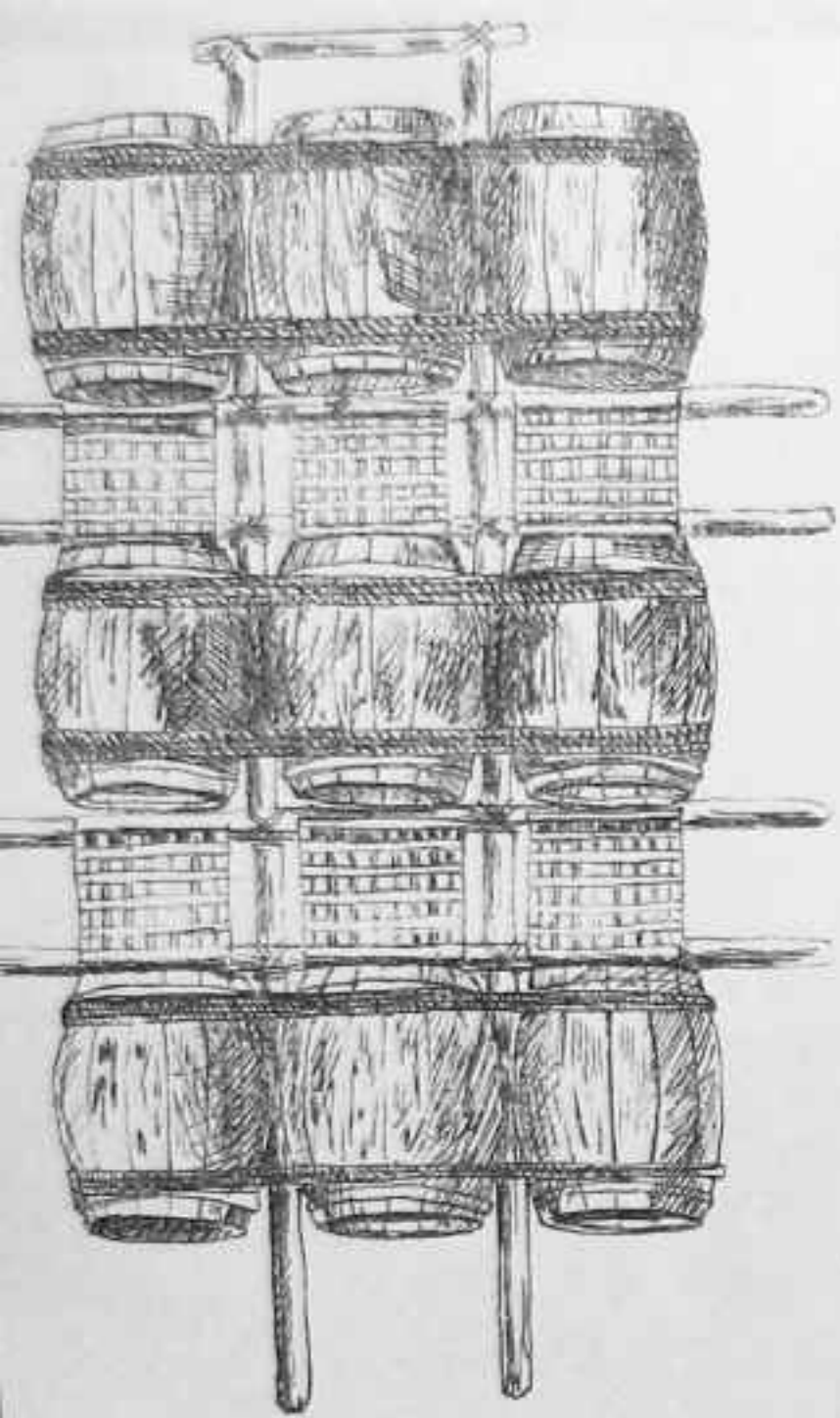

am. 27.

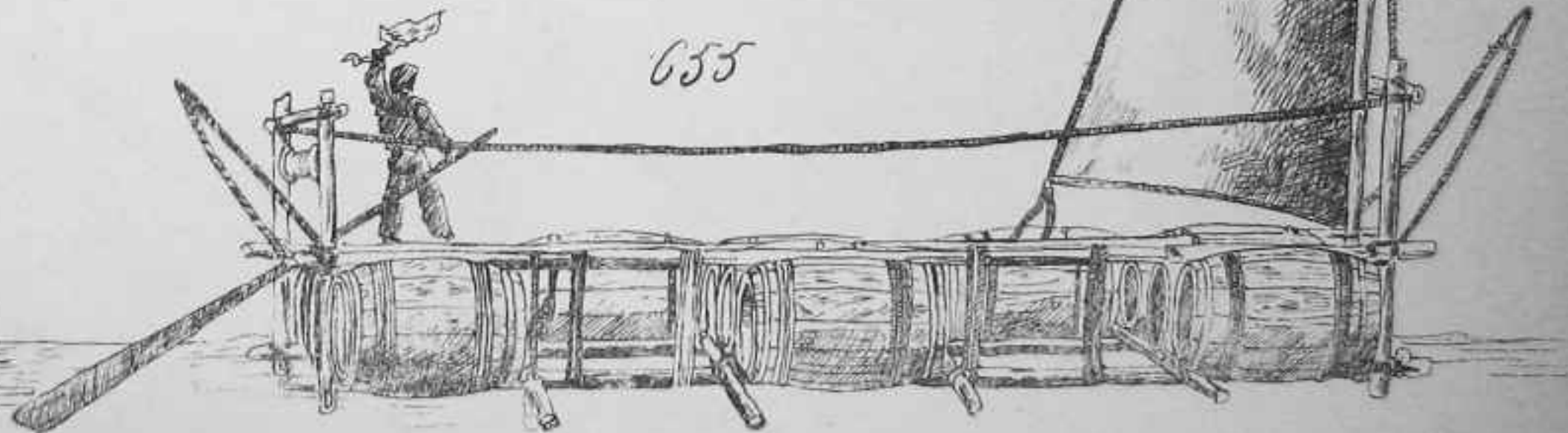
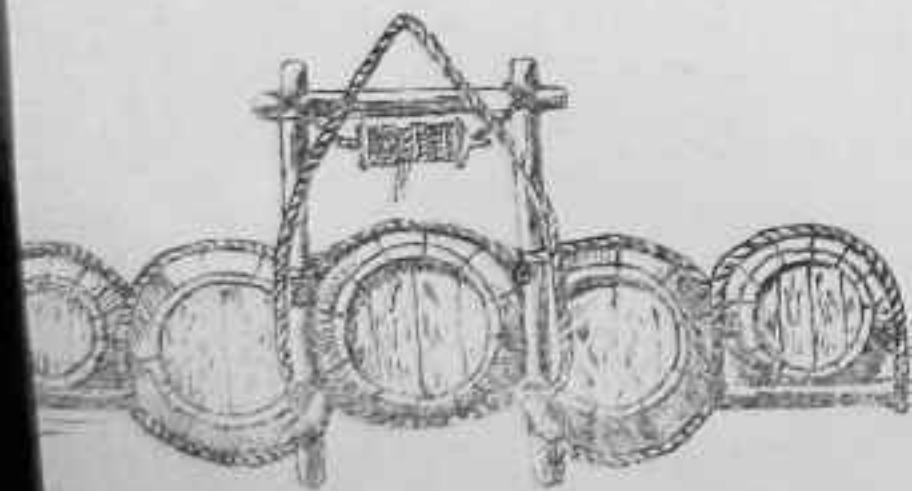

655

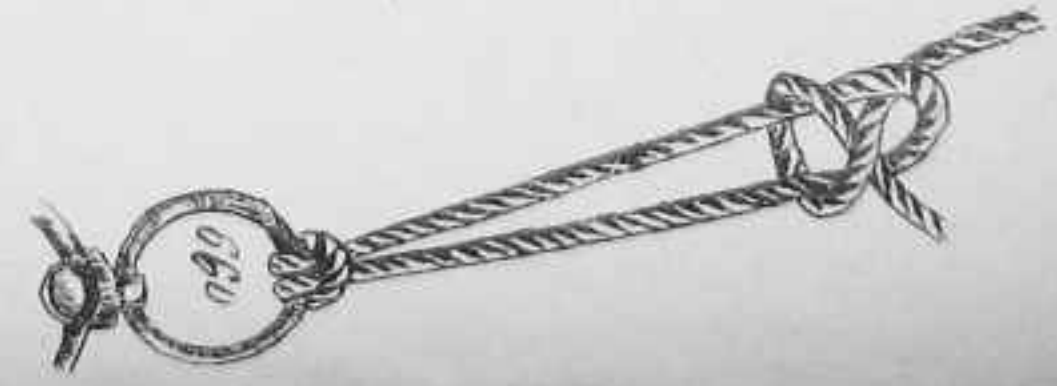
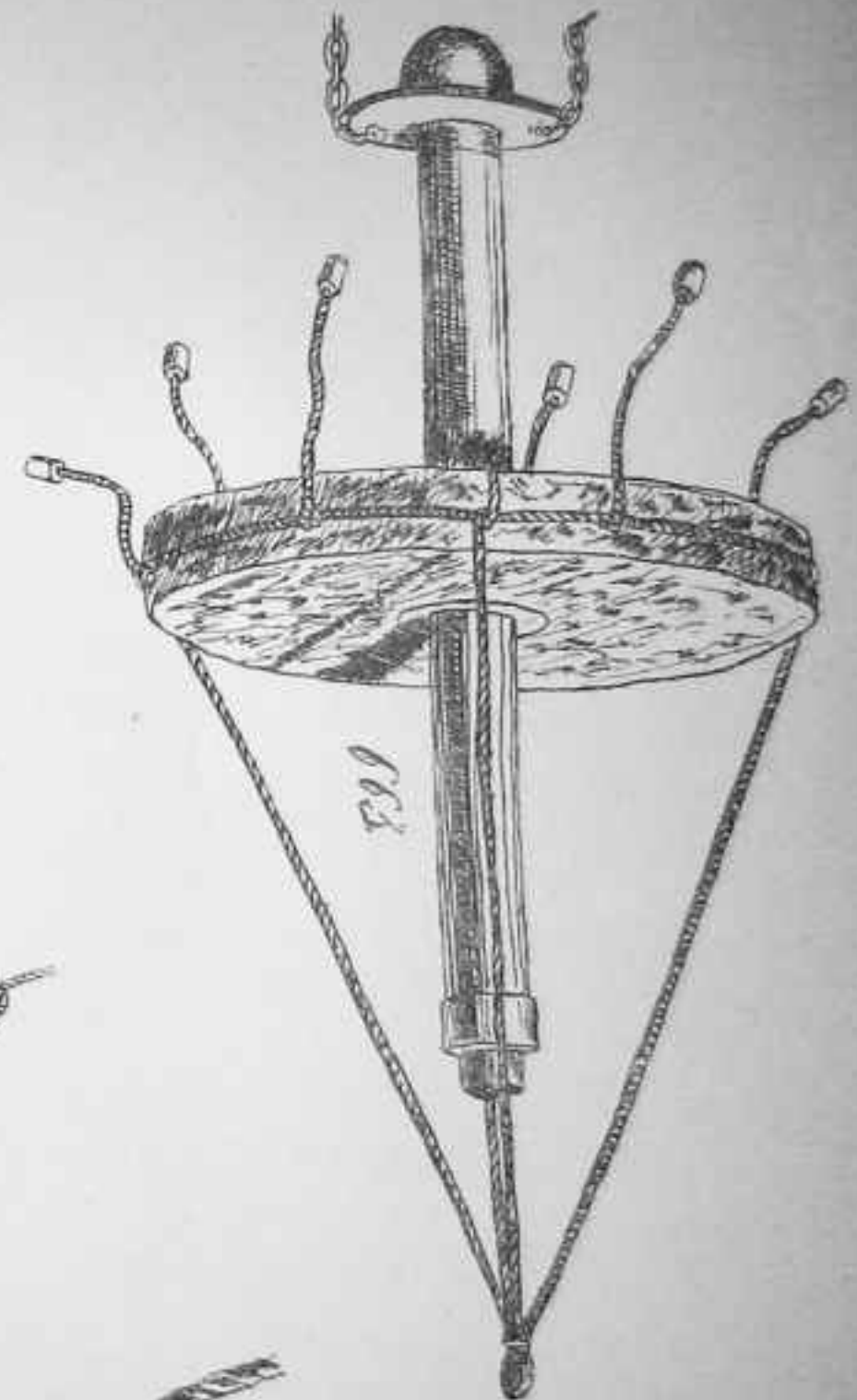
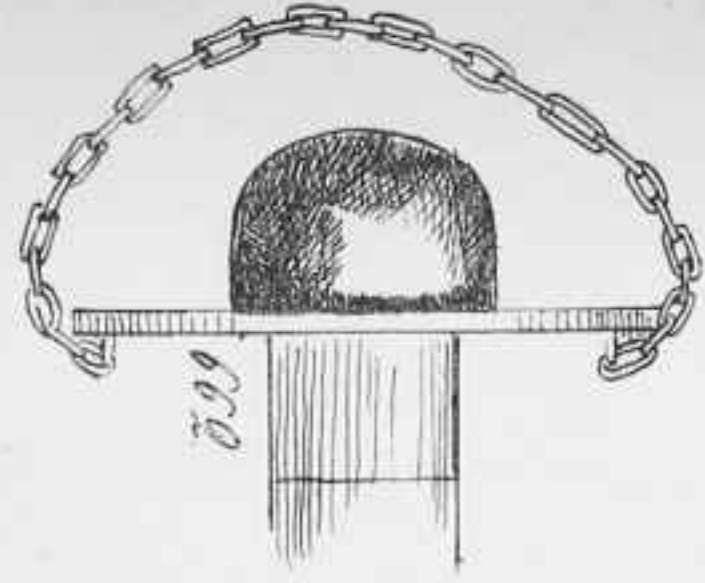
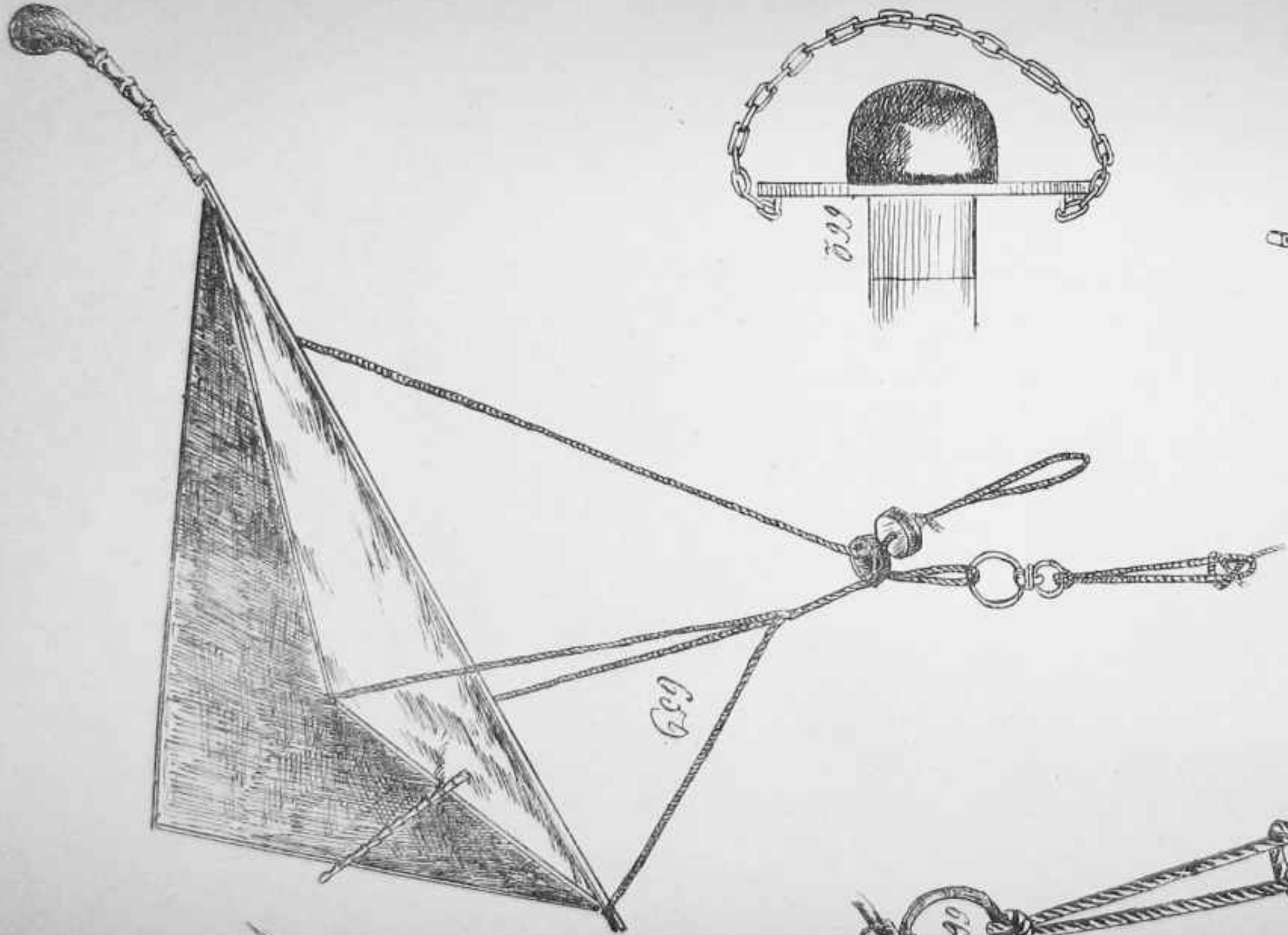

Handwritten text, possibly a signature or date.

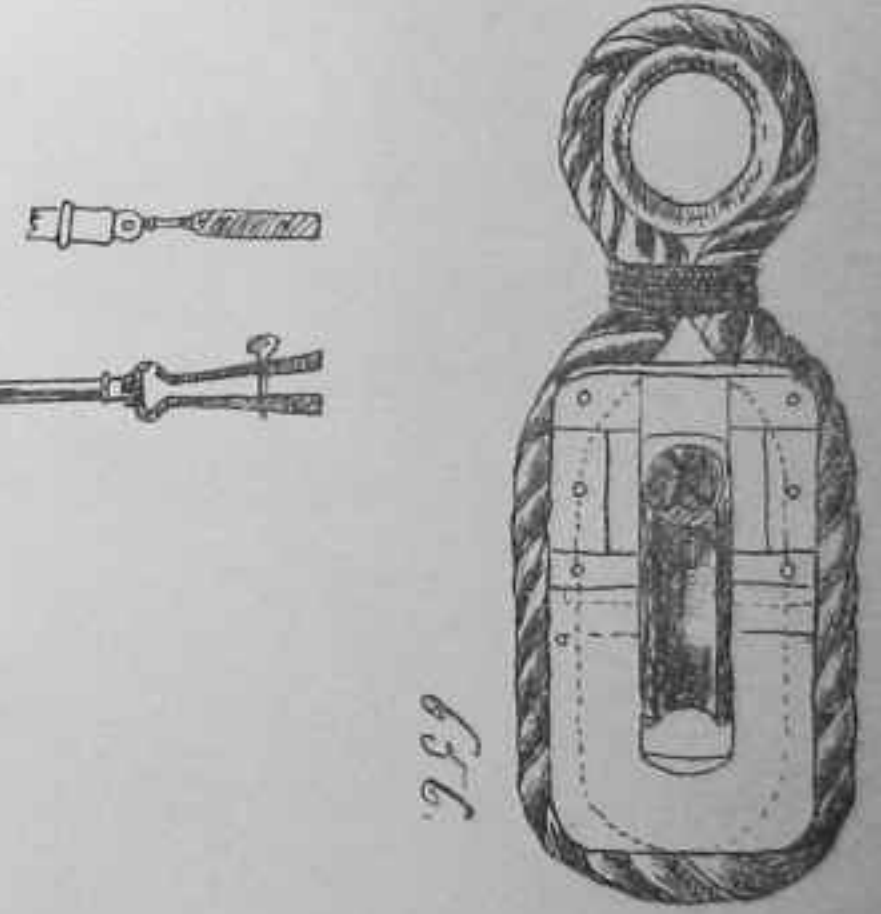
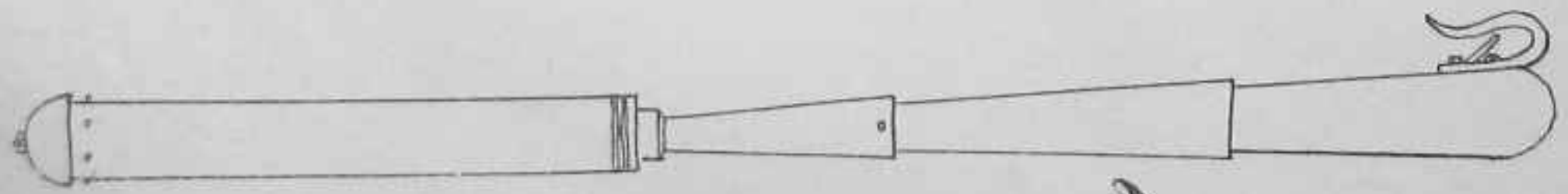
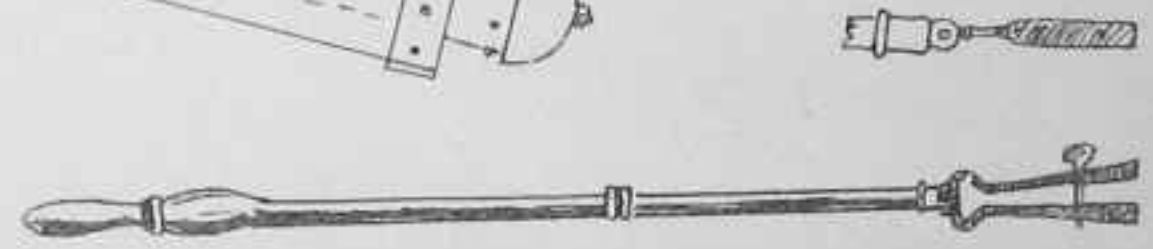
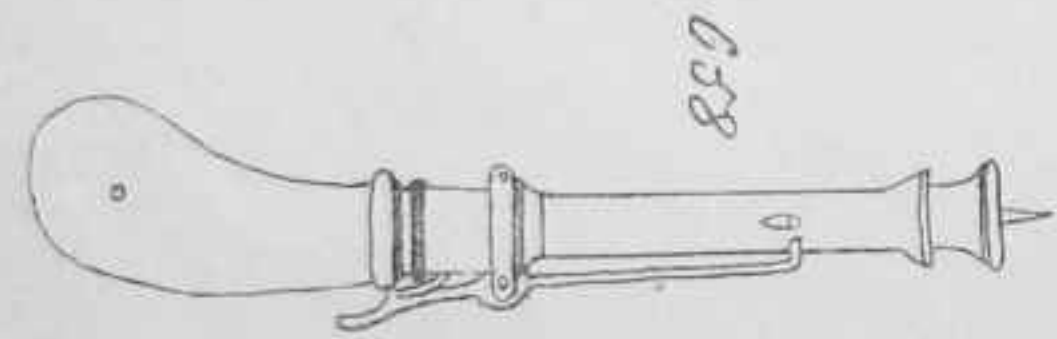
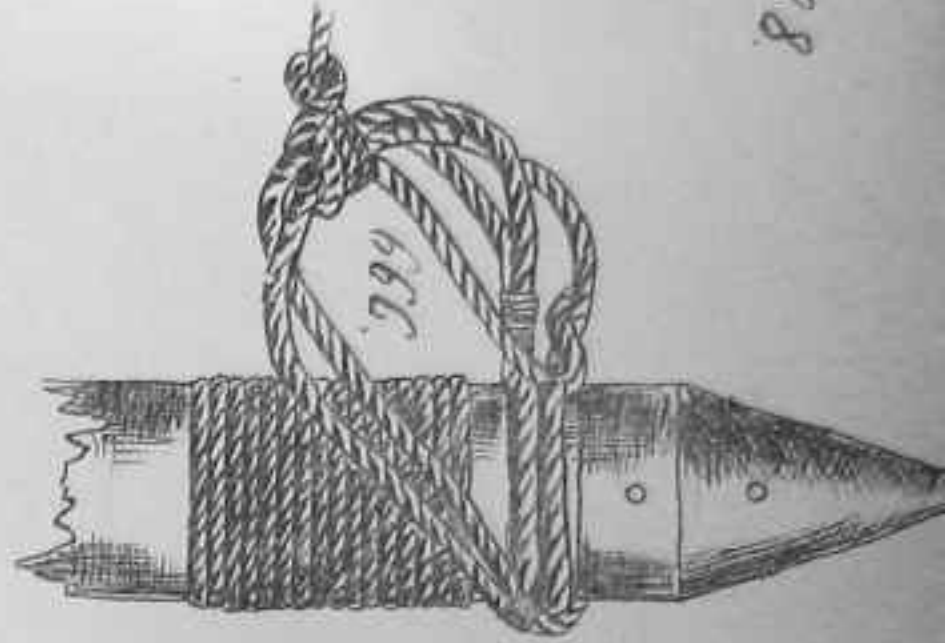
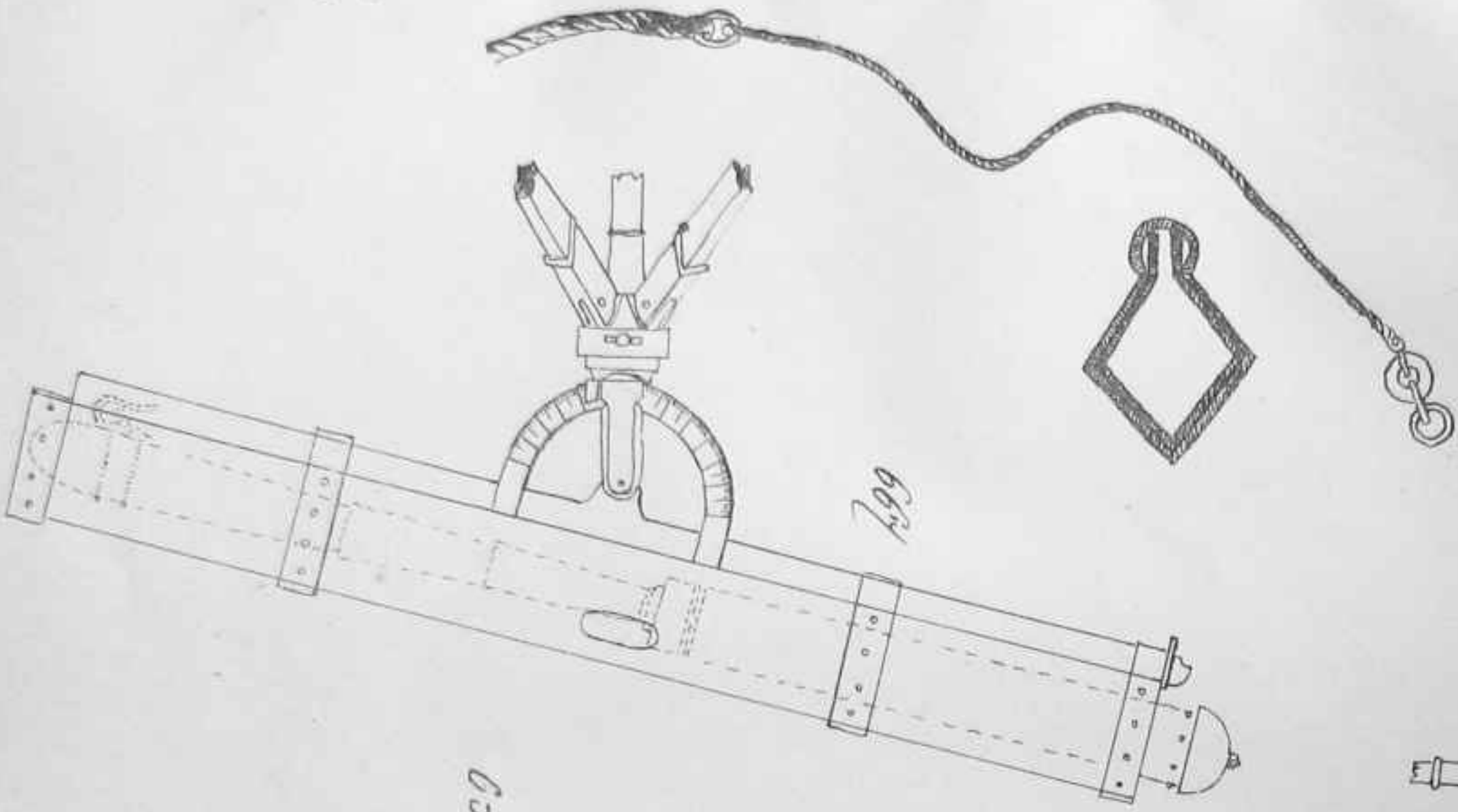

Stuen 2

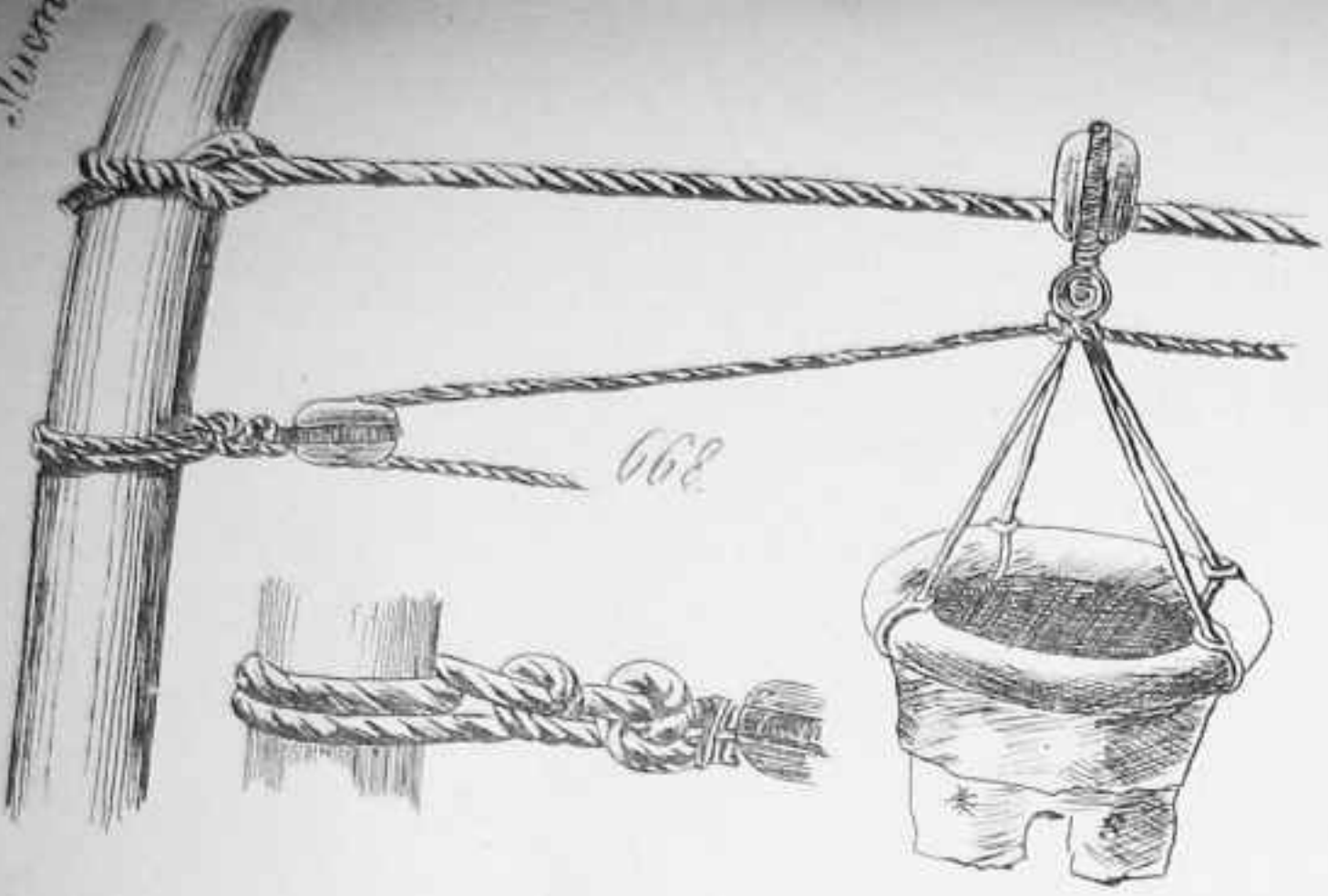

668

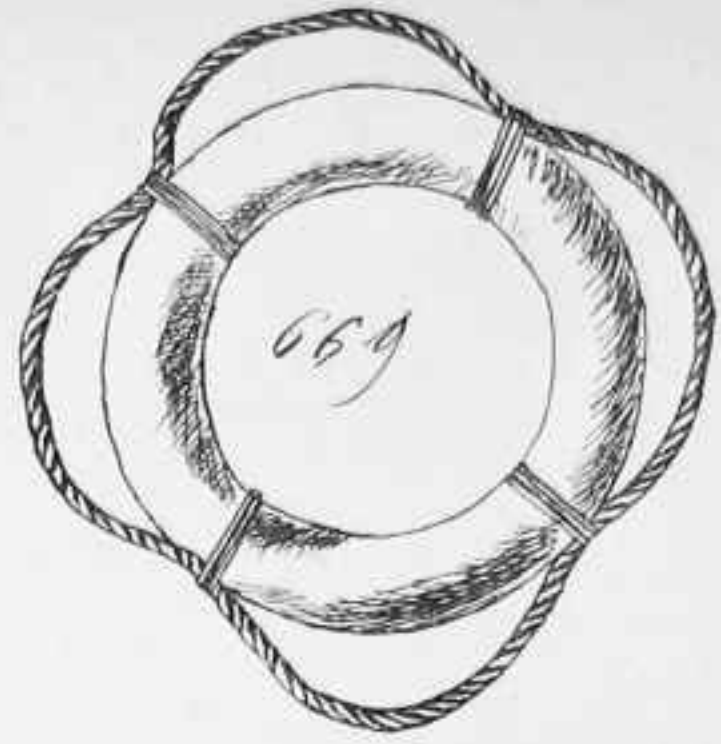

669

unabhängig

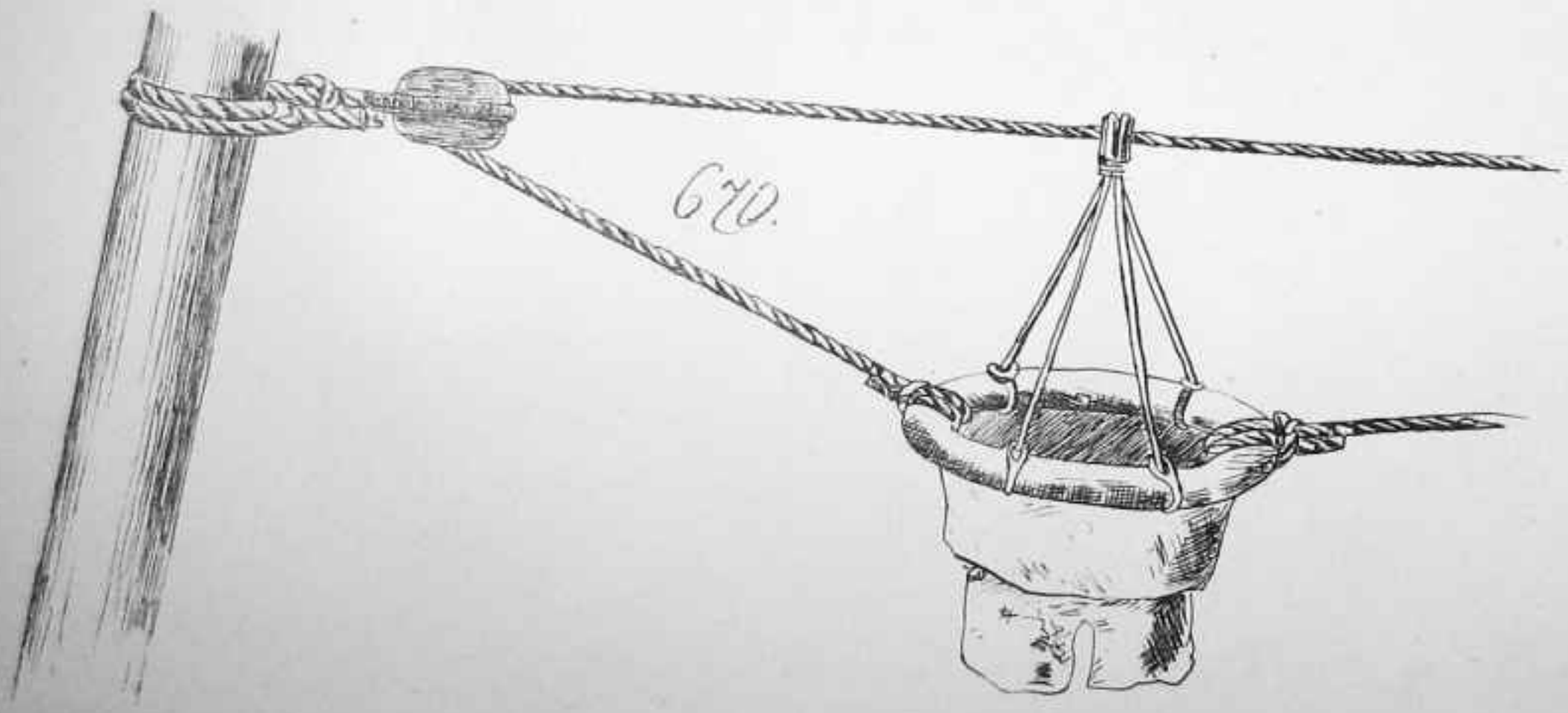

670

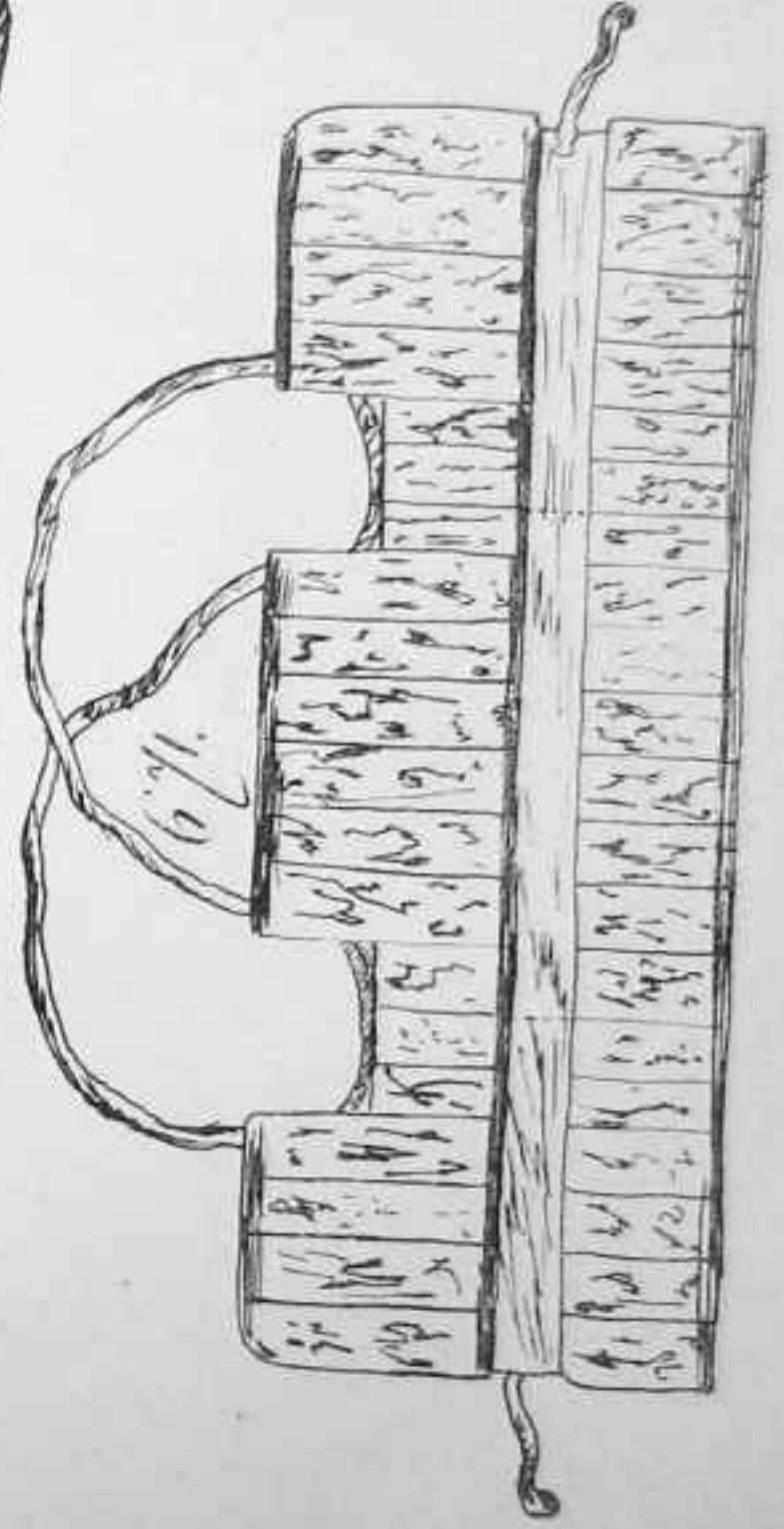

671

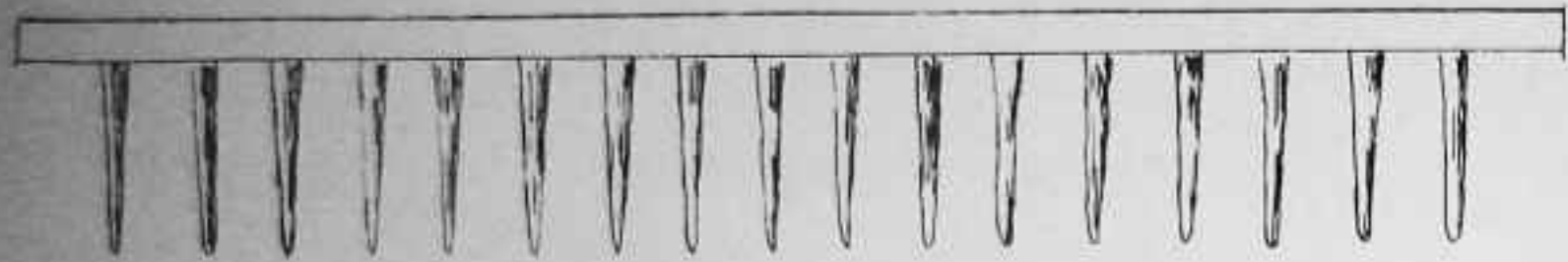

499

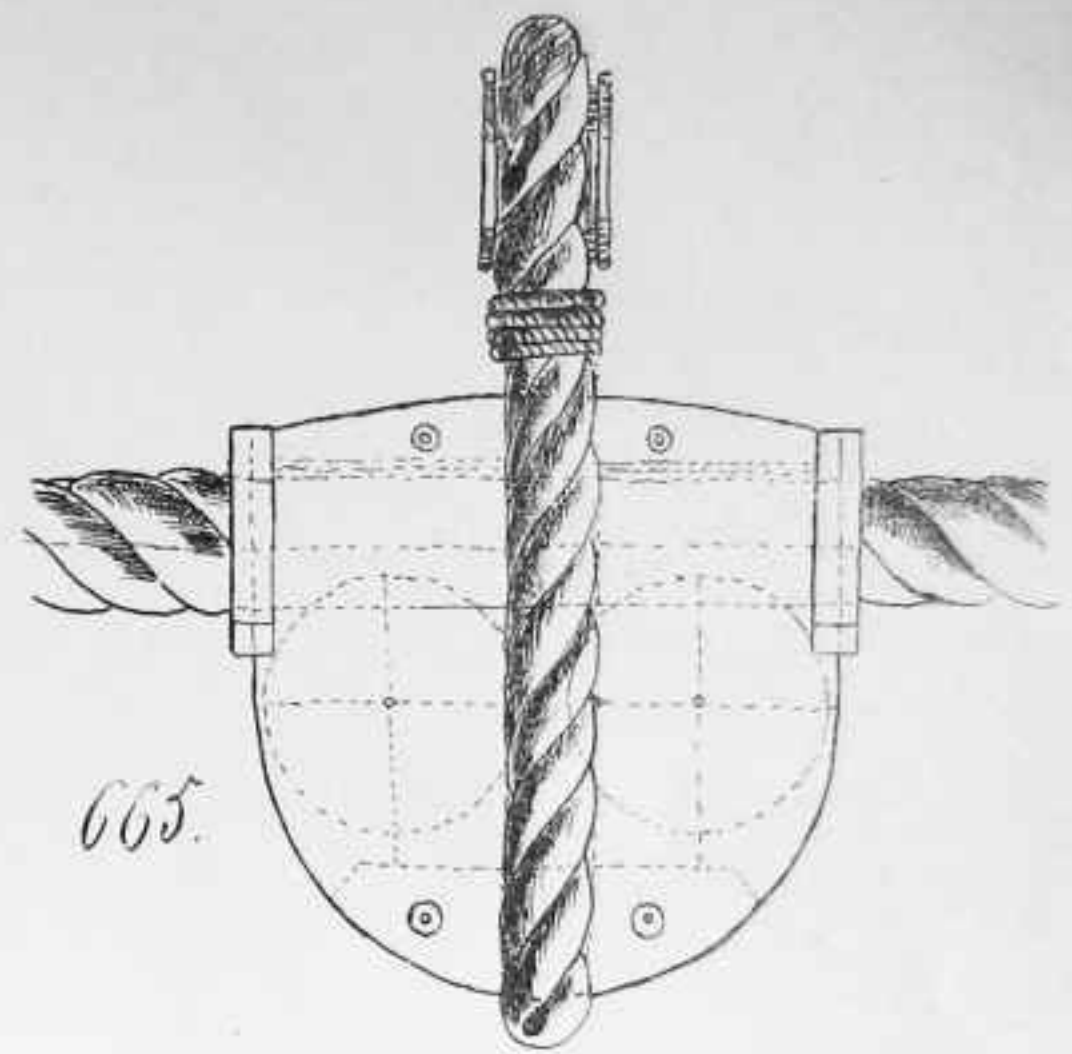
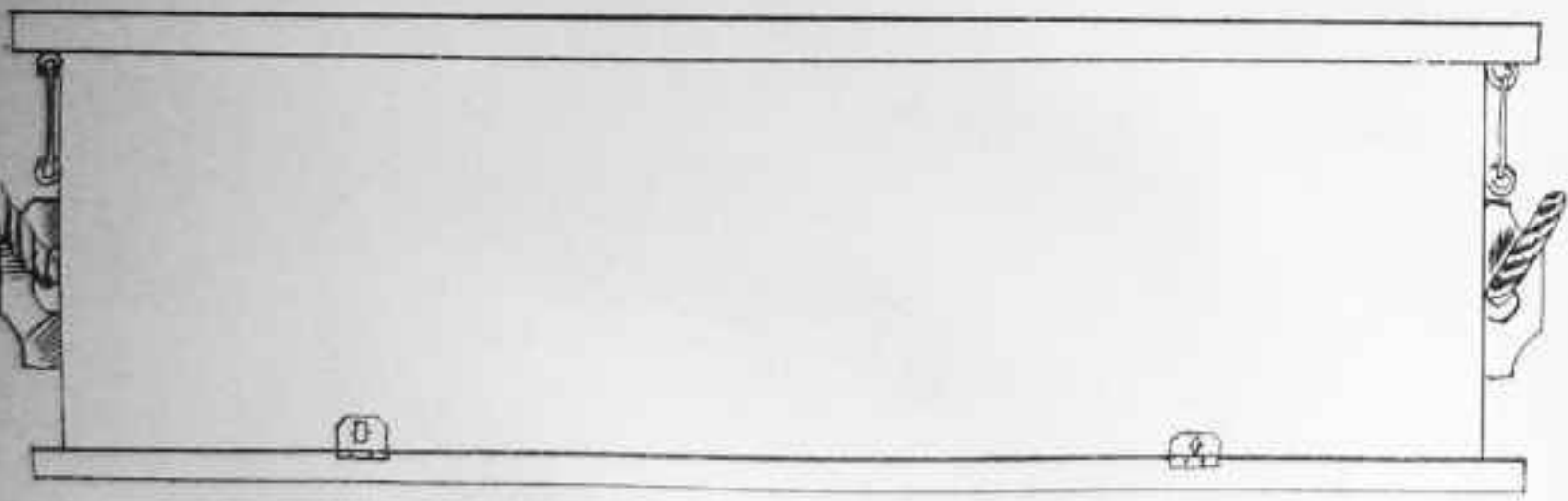
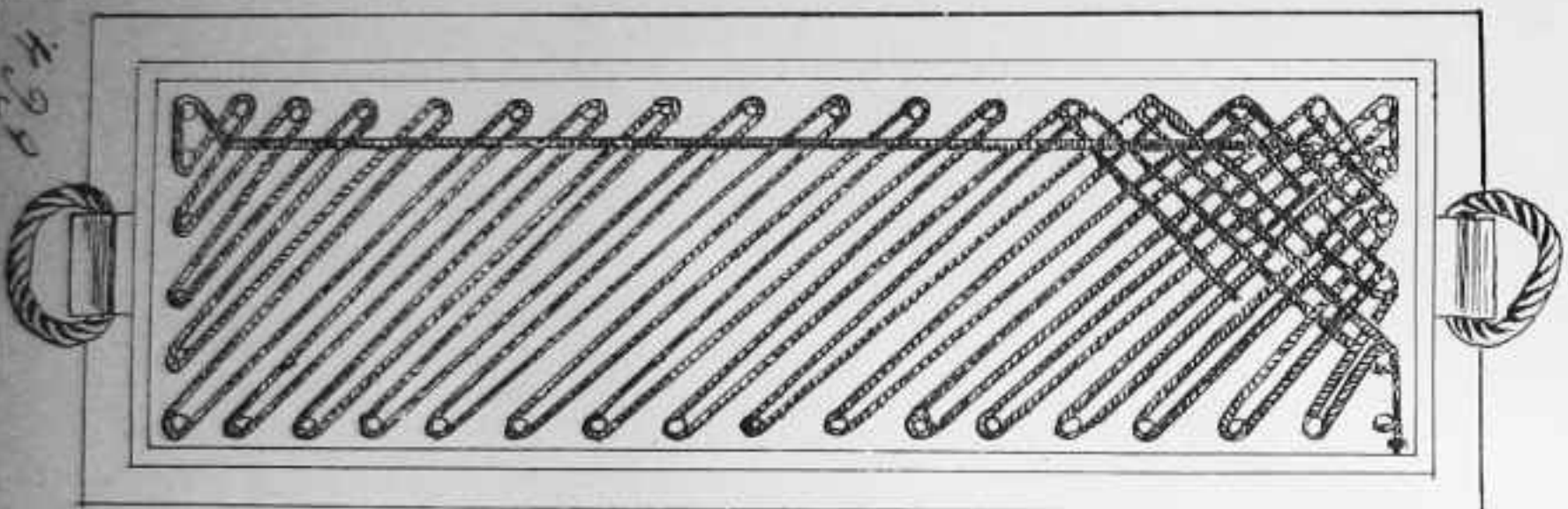

665

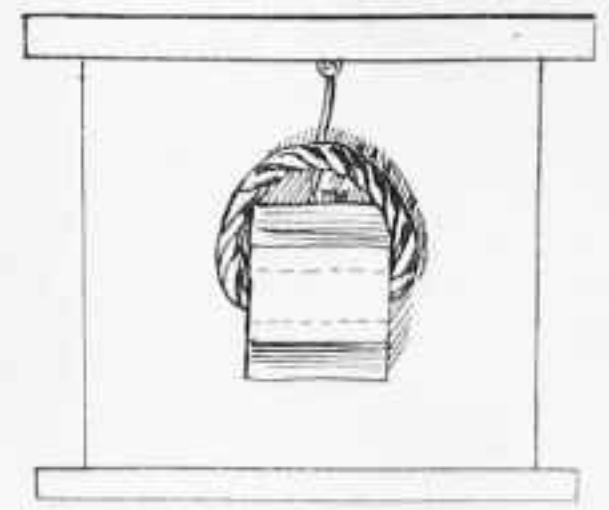

672

Musem. 90.



27. 673.

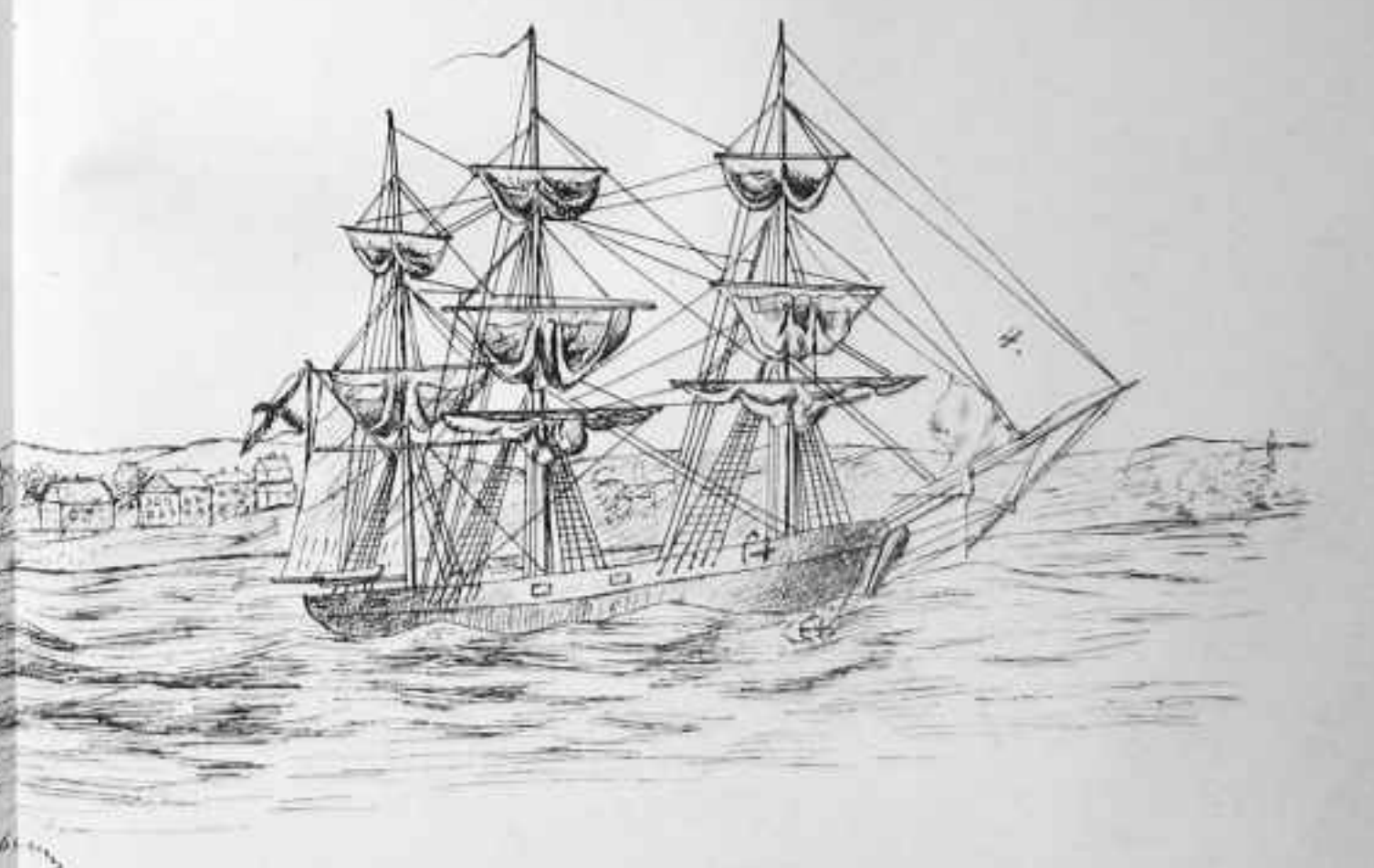
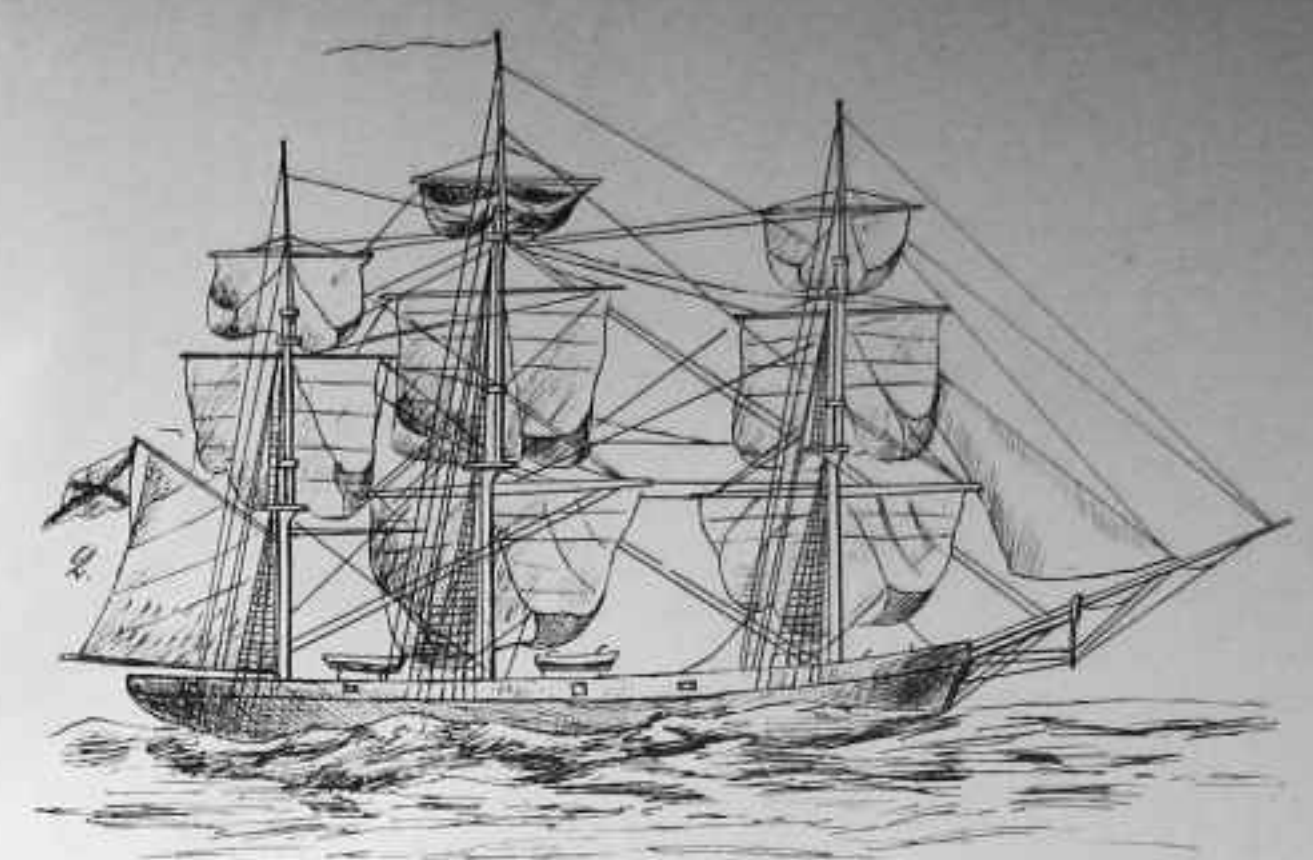

Musem. 90. Copy 673.



7

674



8



9



10



11

K. By Cooper



12

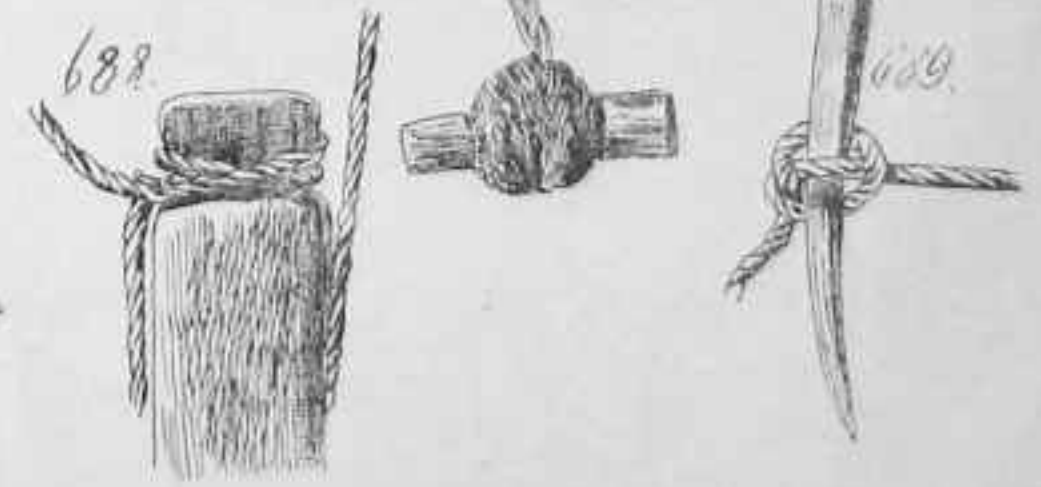
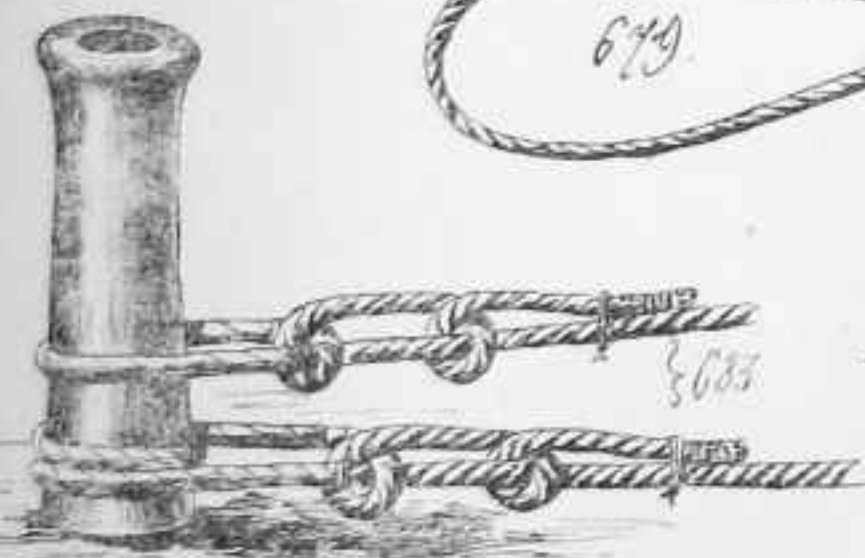

R. G. Cooper

Aug. 93

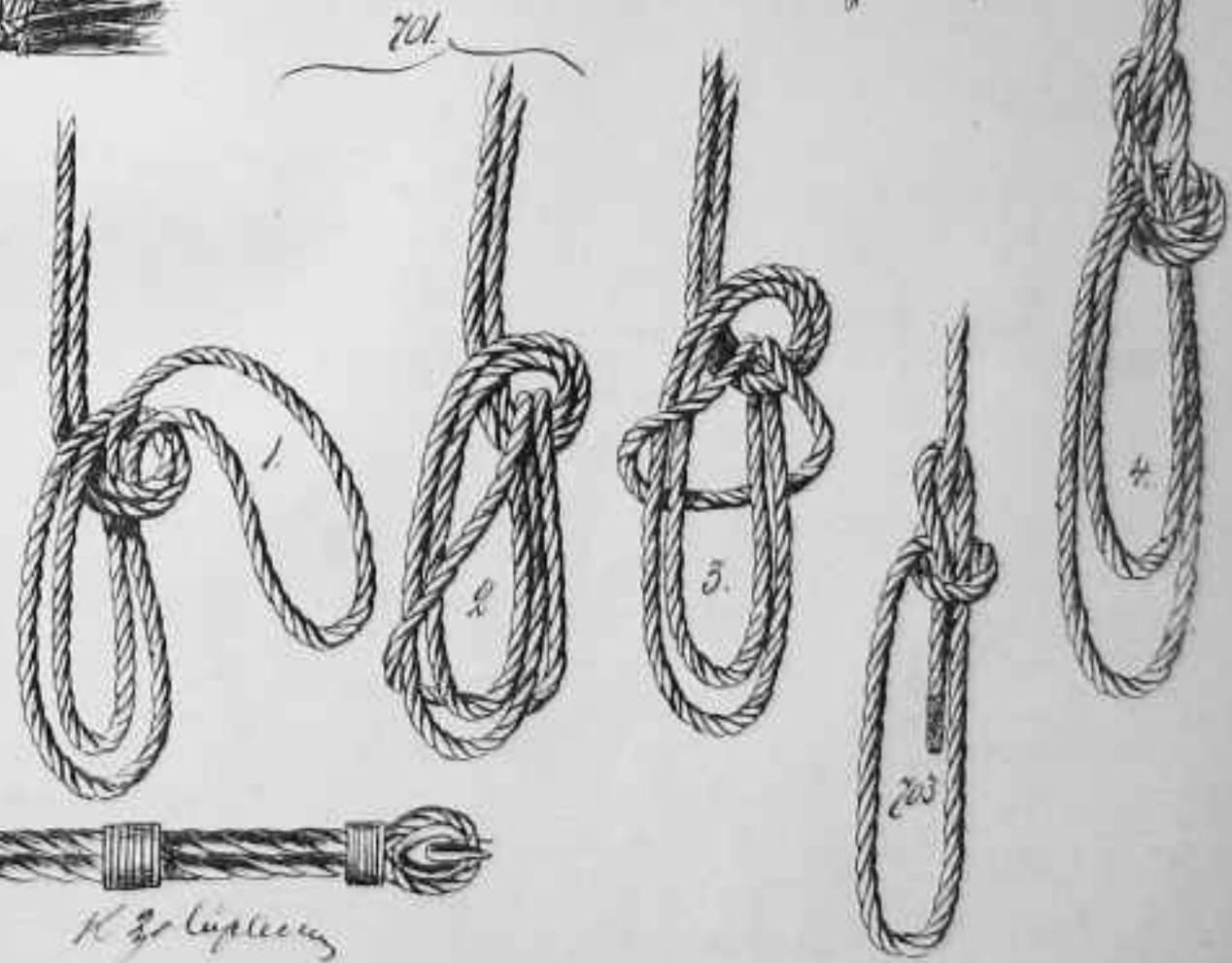
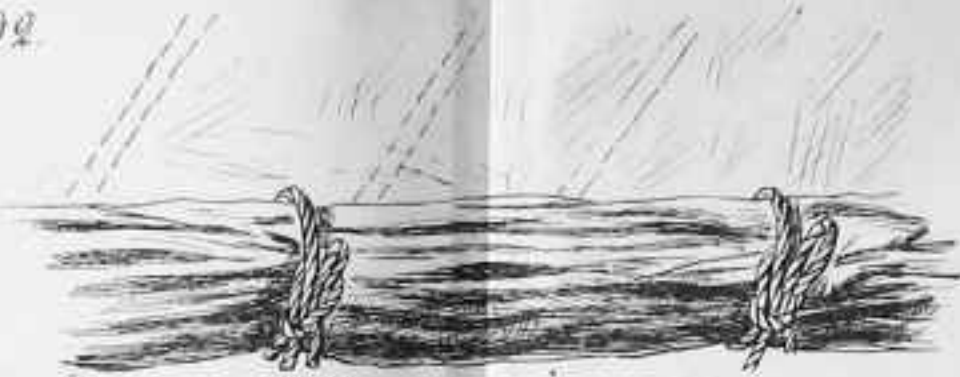
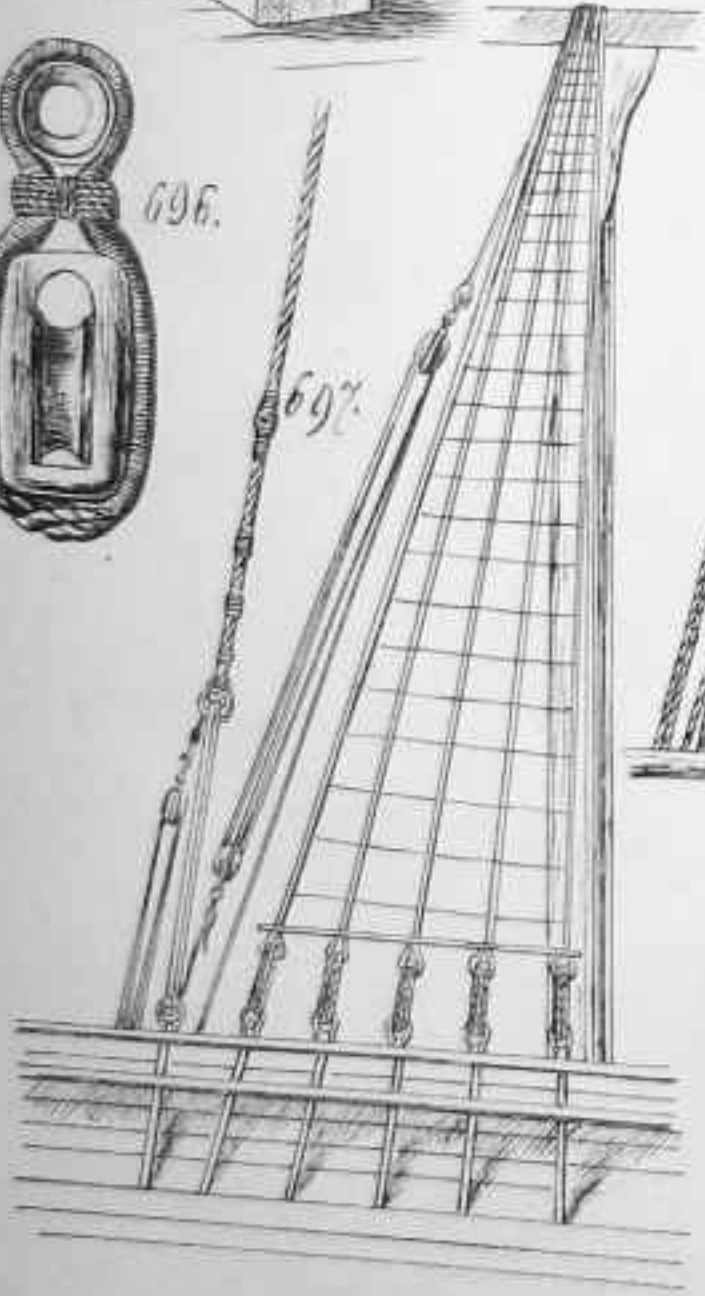
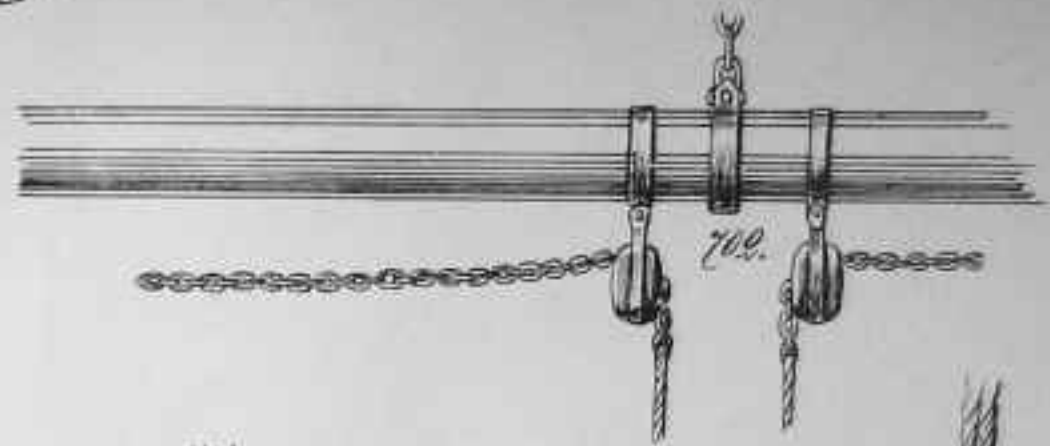
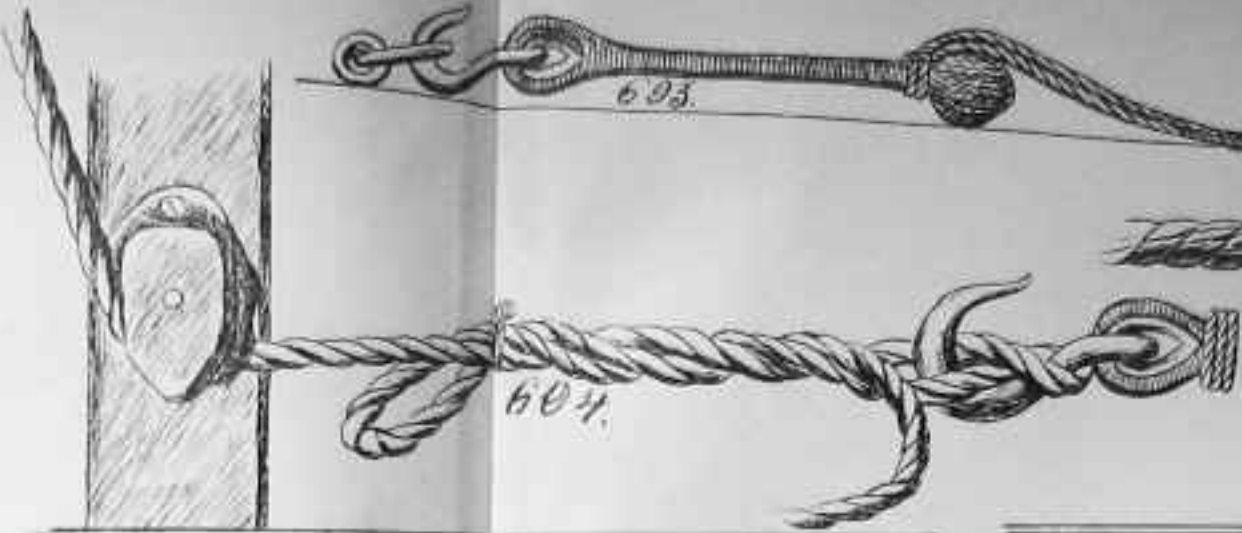
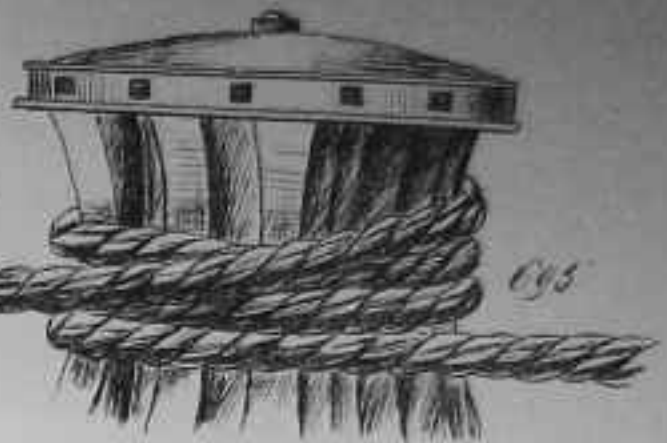
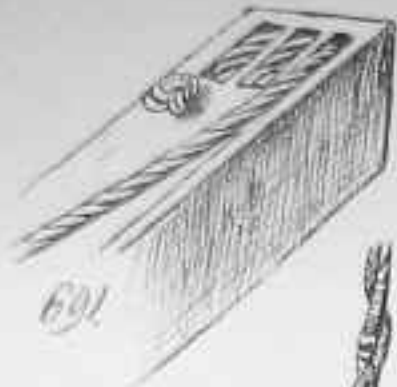

1/2 cupline



707

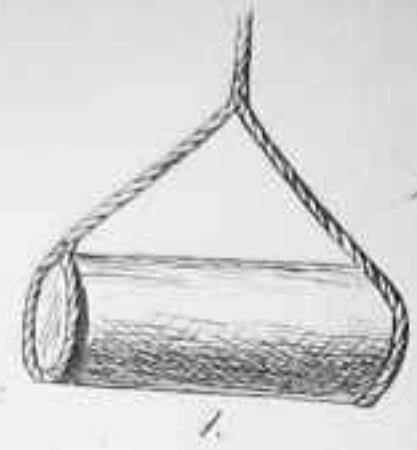

708

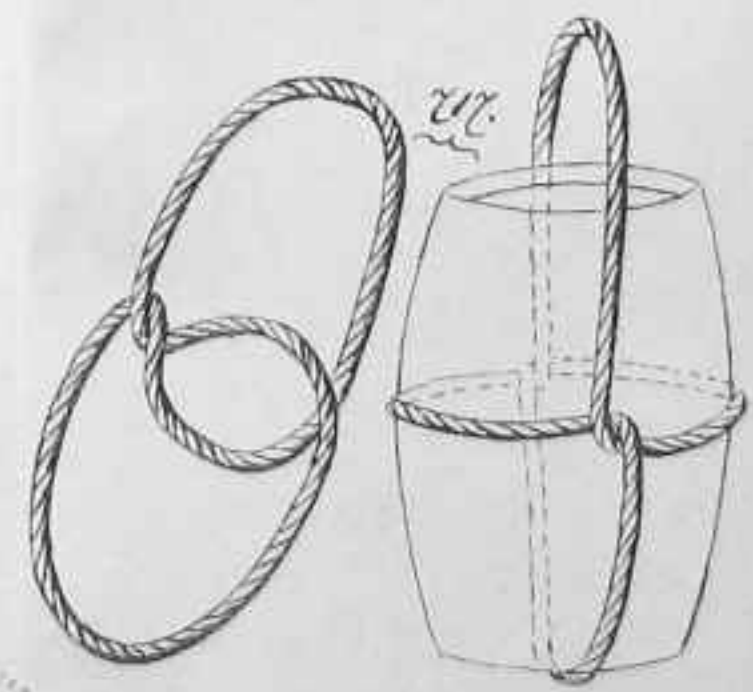
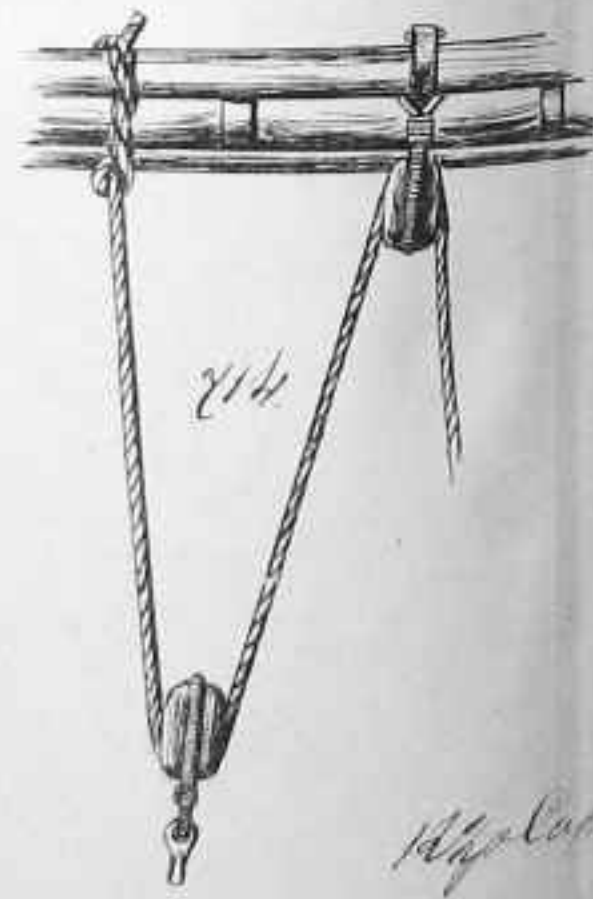
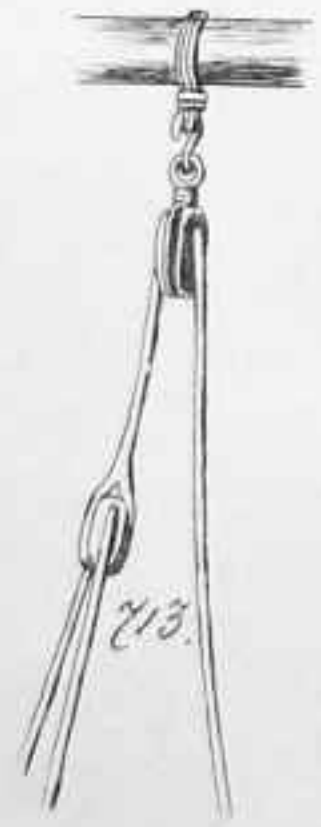
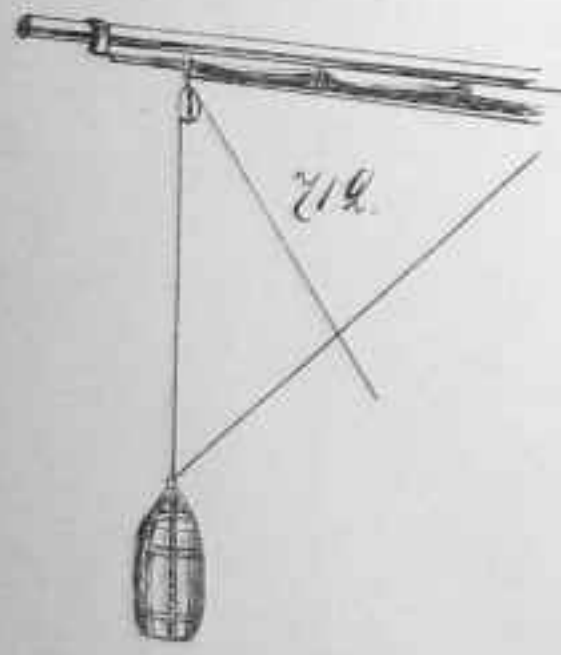
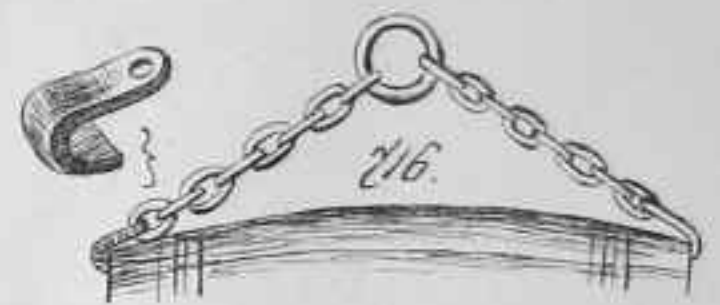
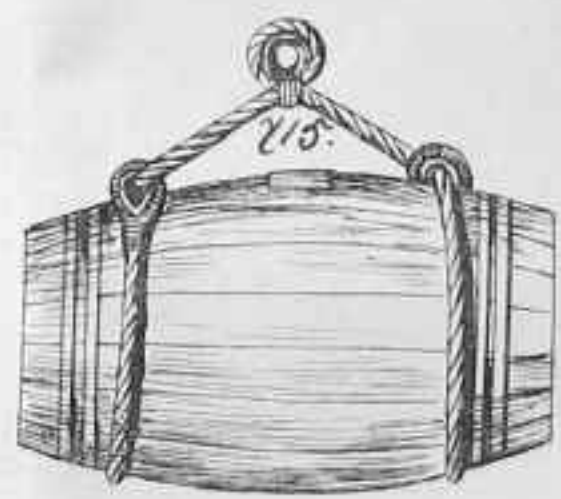
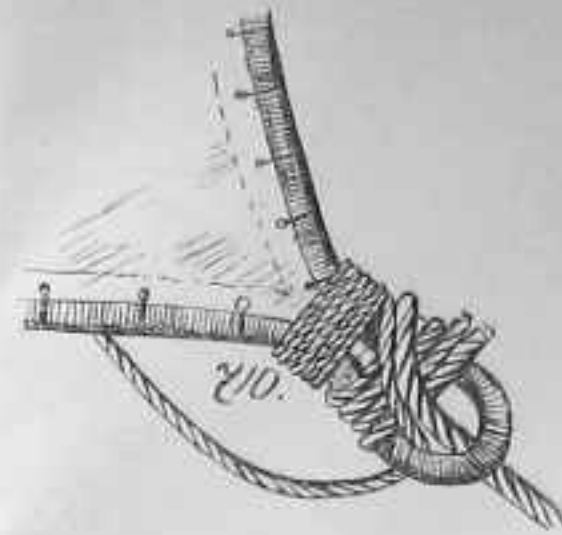
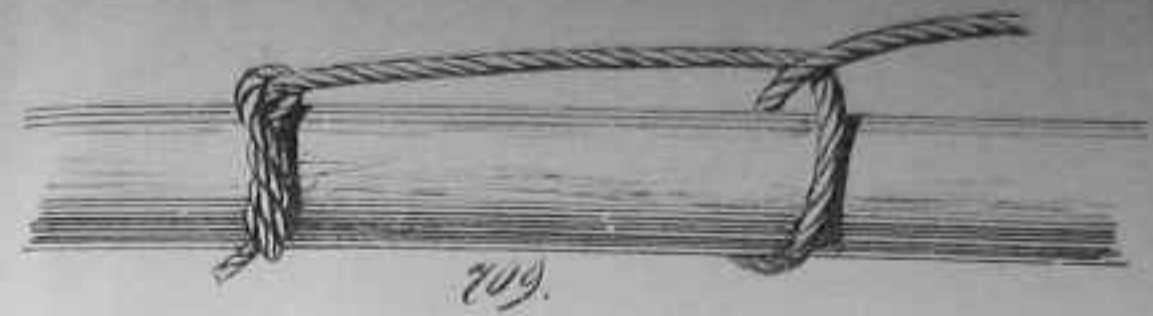

719

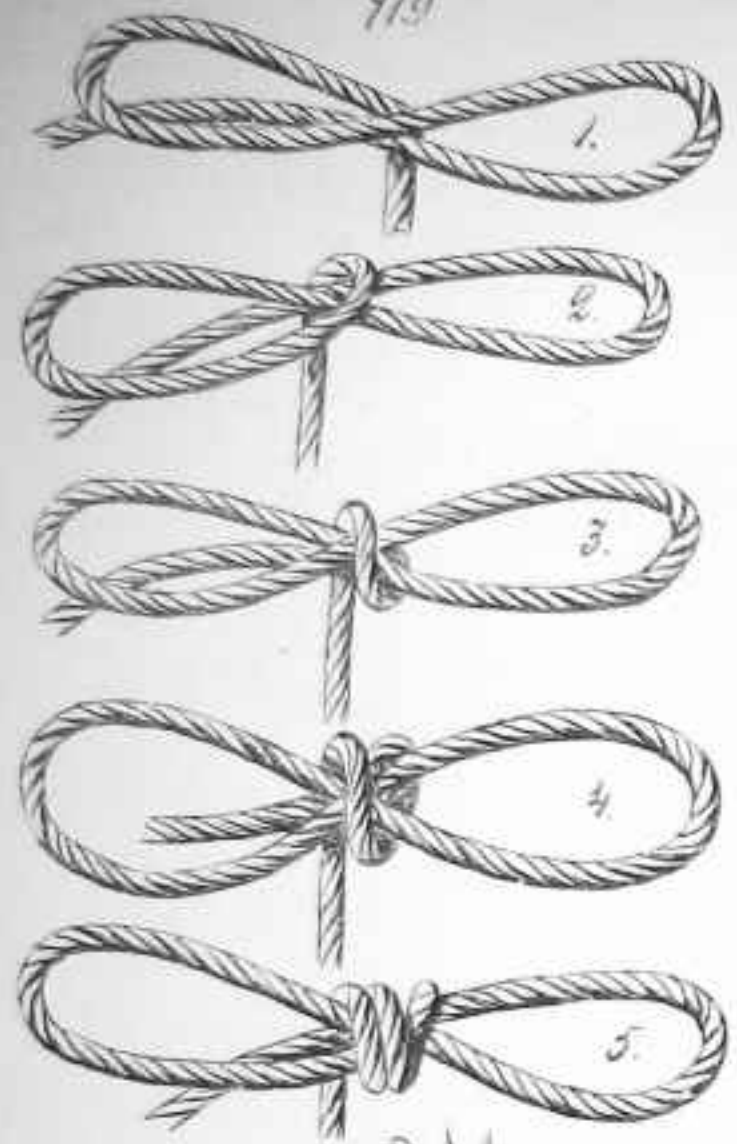

720.

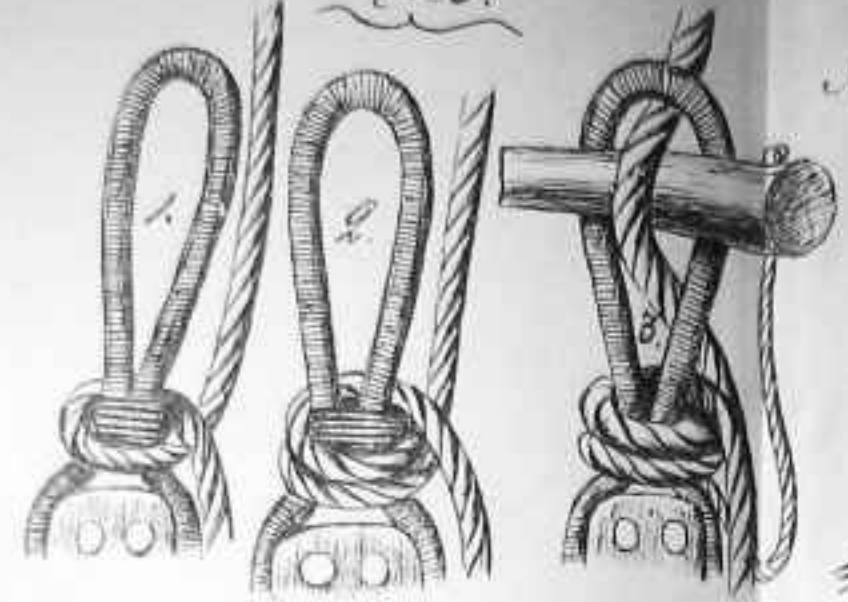

Sturm 95.



722.



723

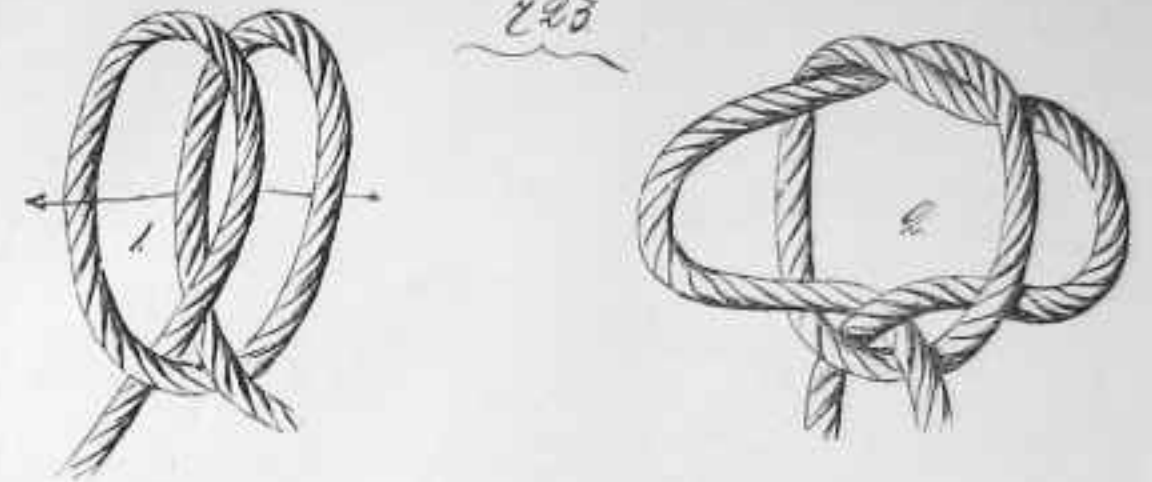

724.



725.

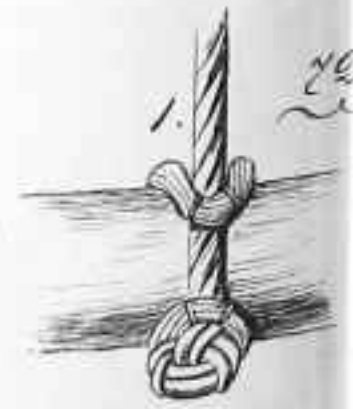

2



726.



727.



3

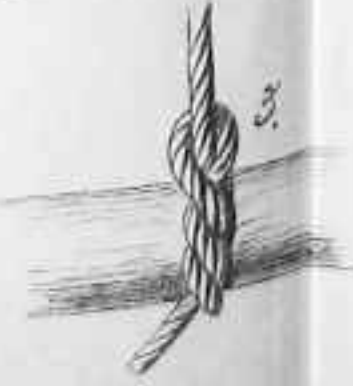

H. F. ...

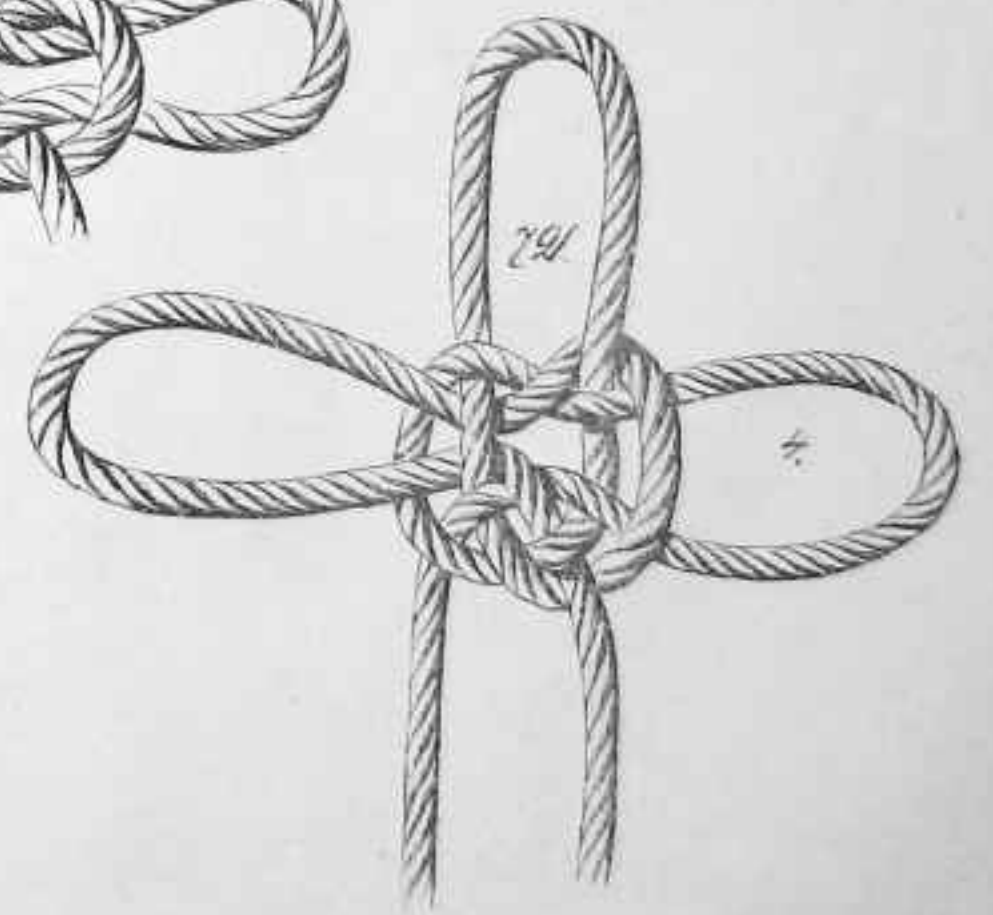

728



729



730

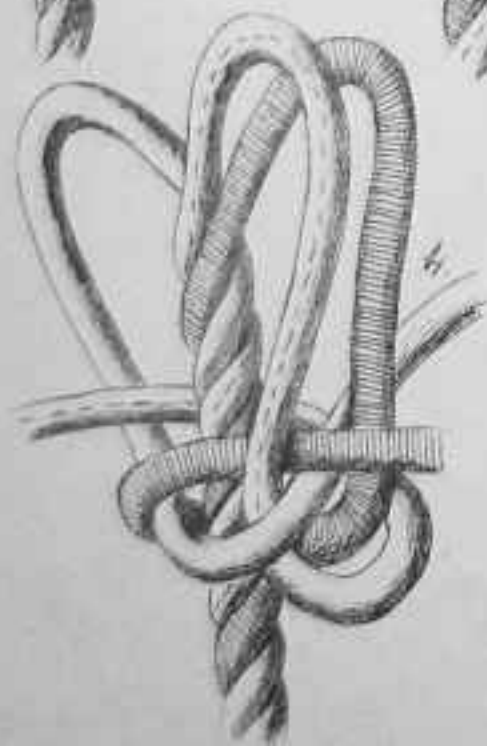
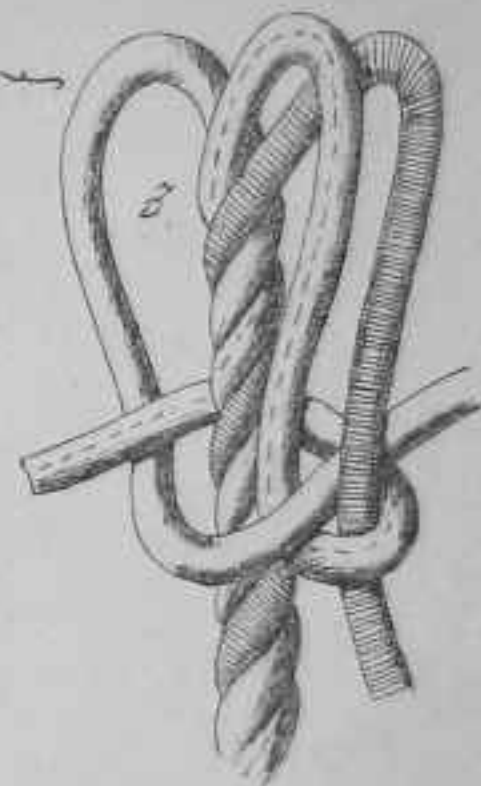
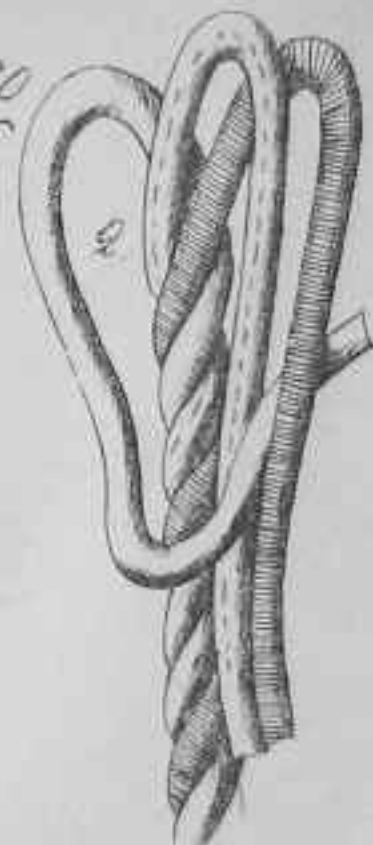

730



731



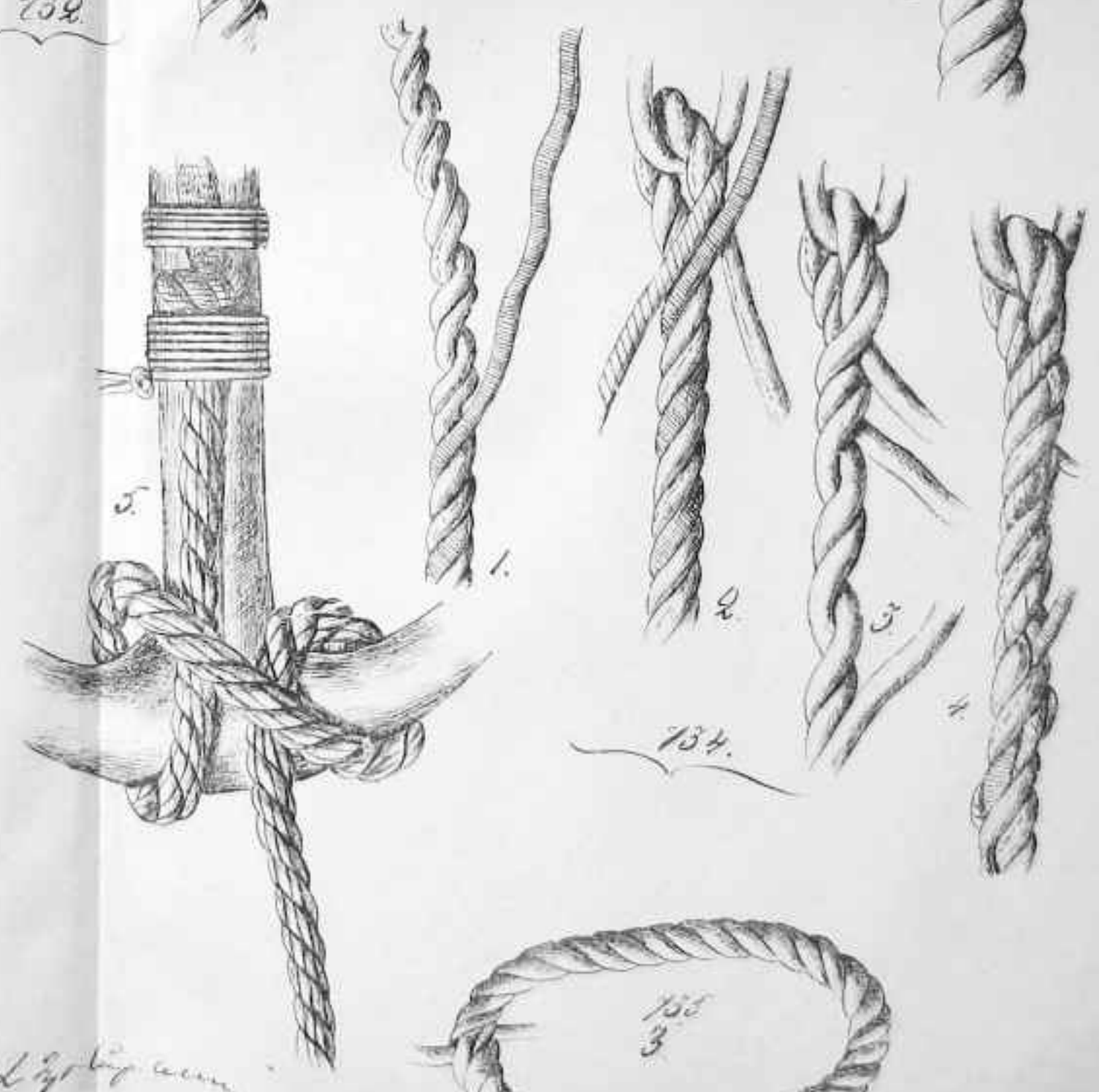
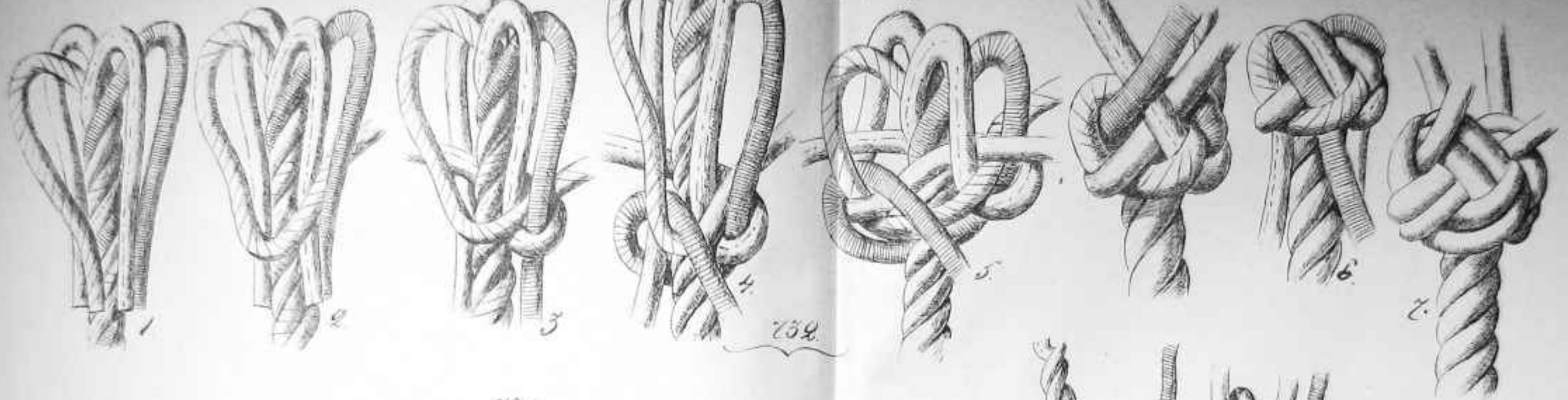

Ed. 2^d by ...

Mucm. 98

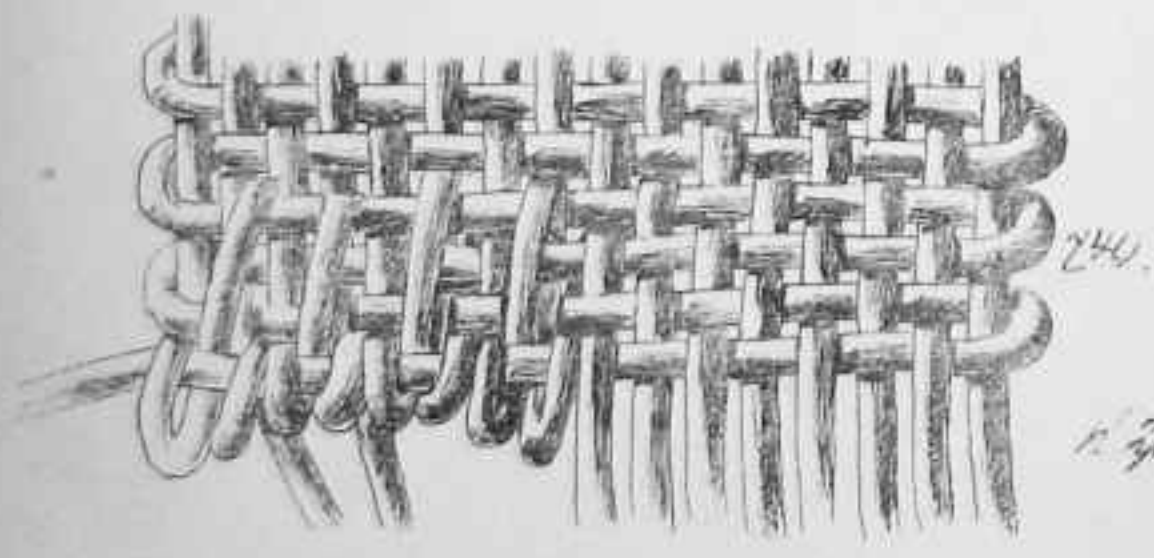
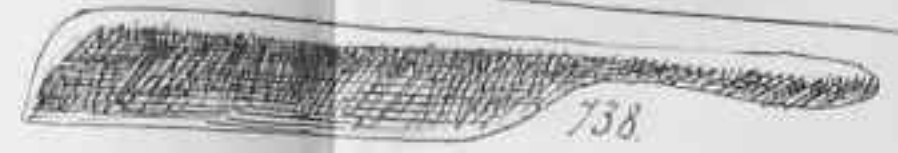
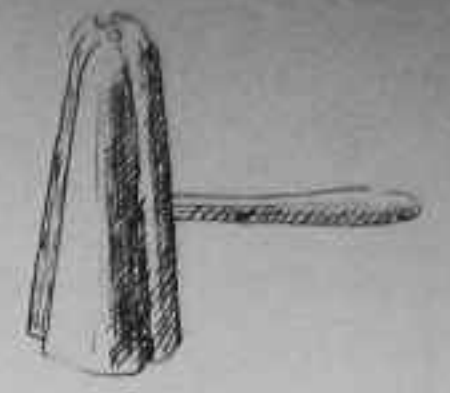
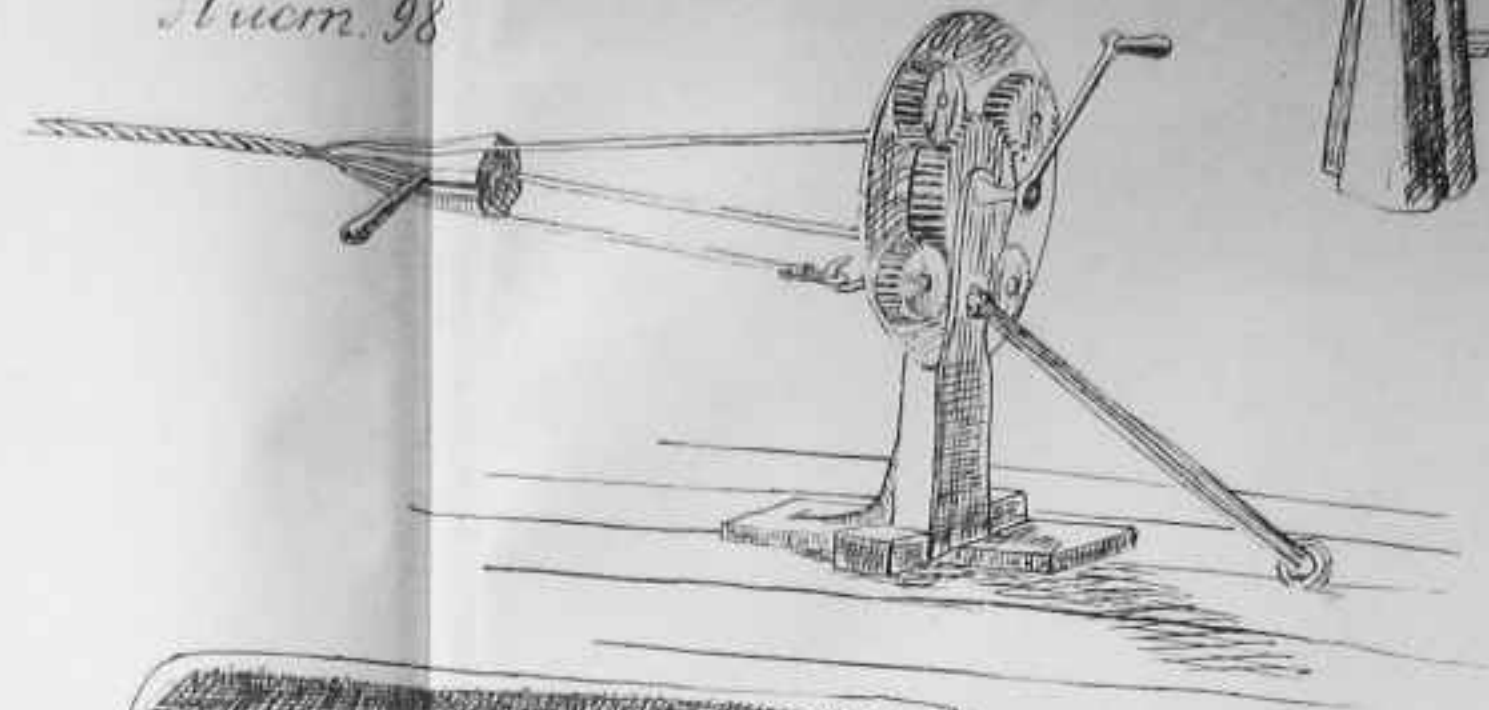
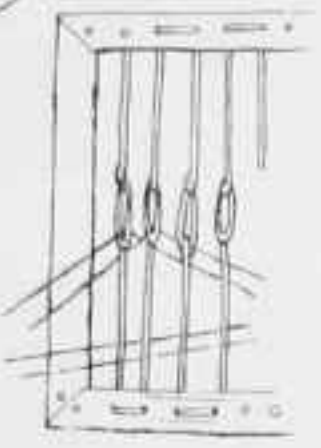
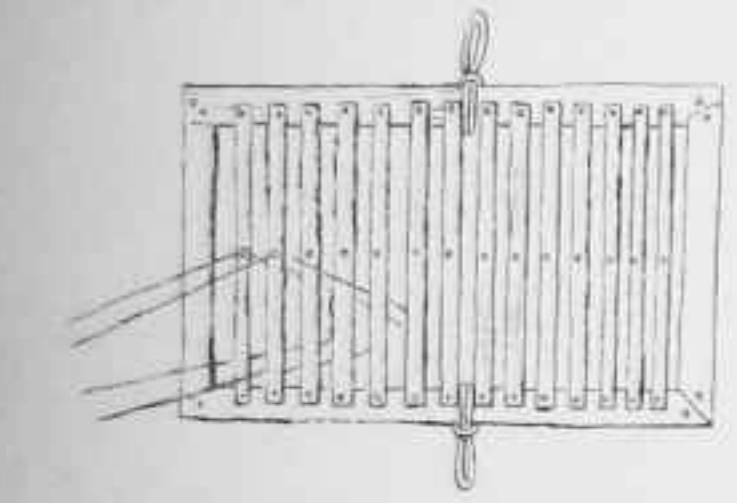
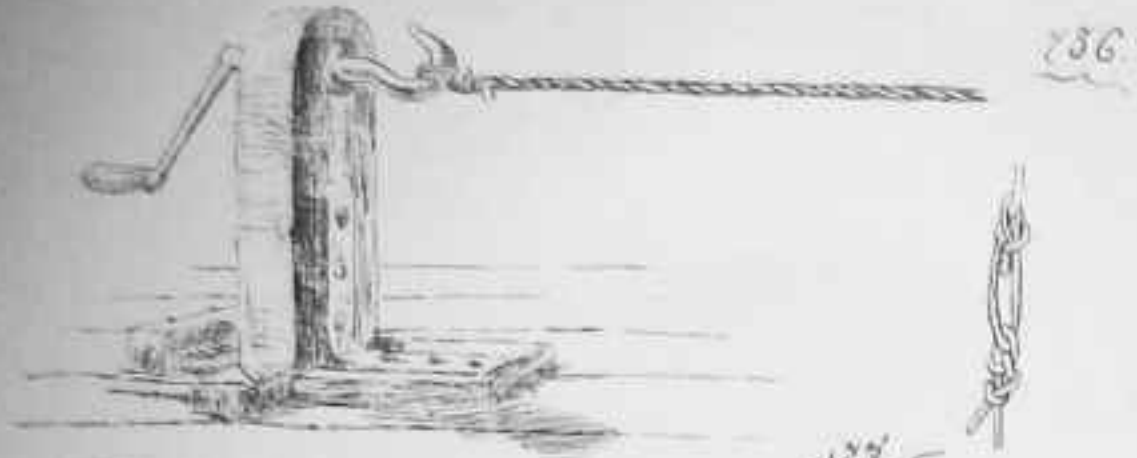

1. 70. 187. 188.

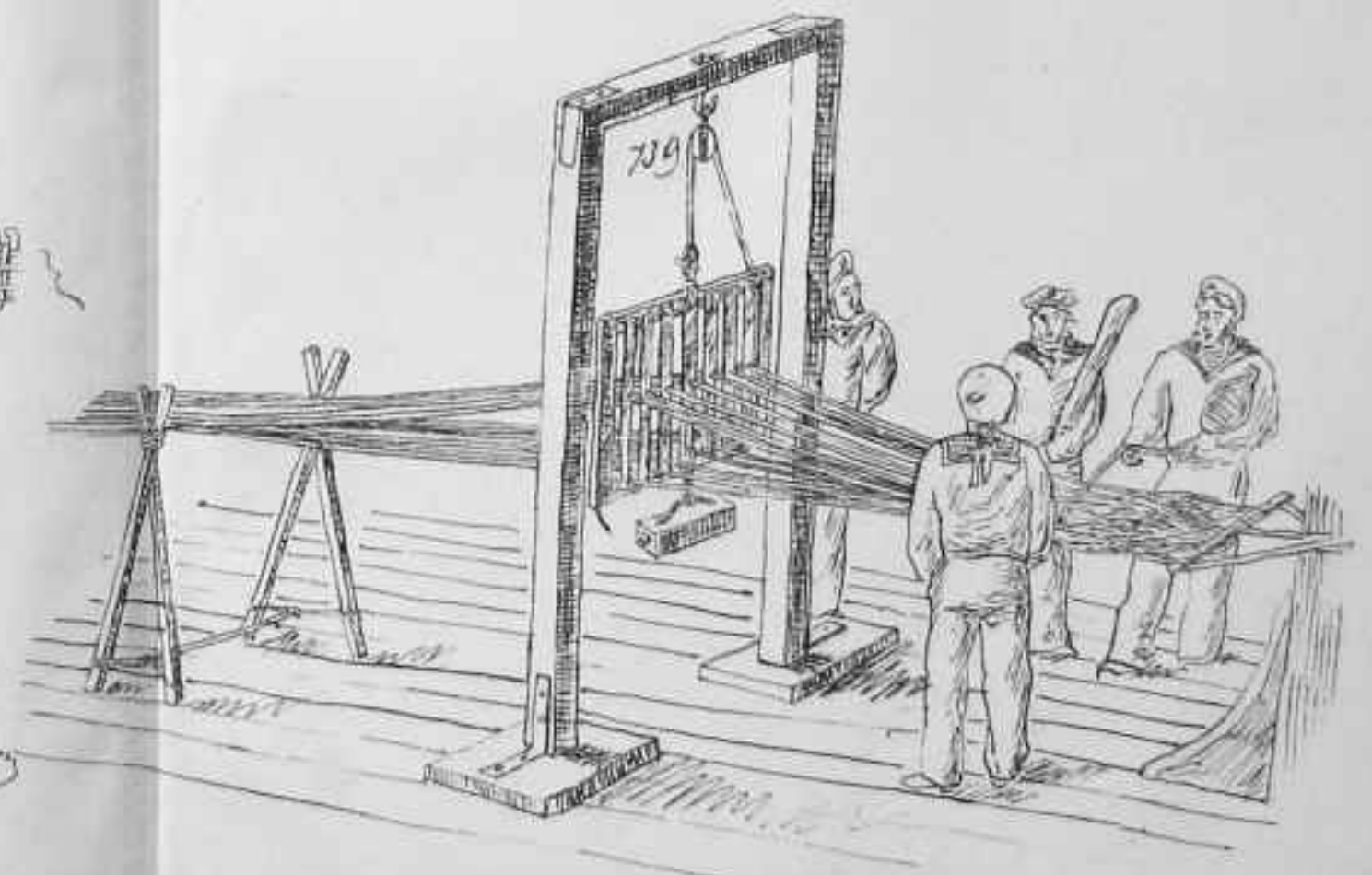

March 99.

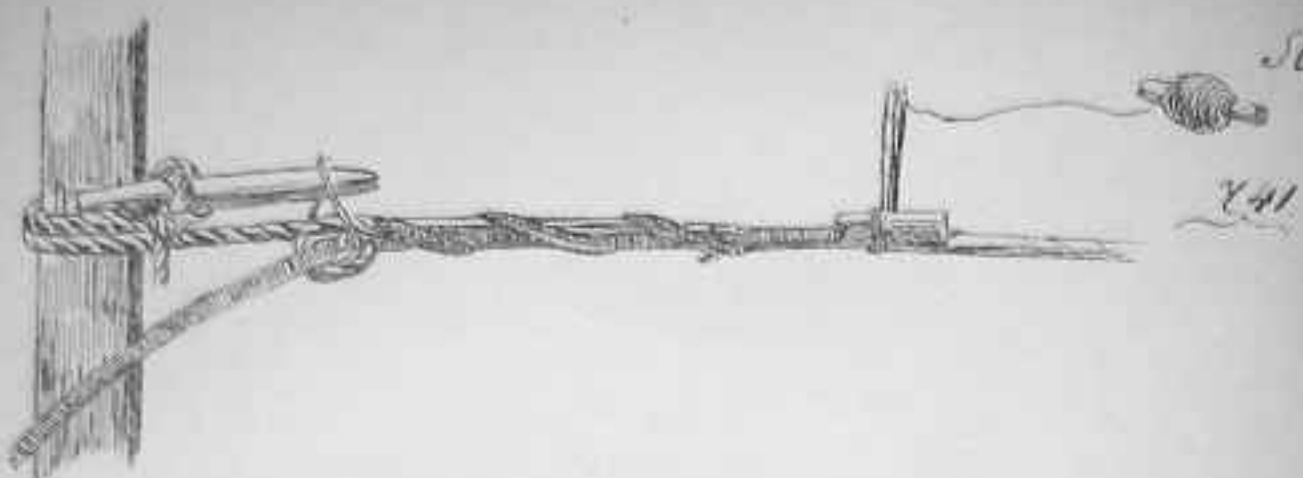

741

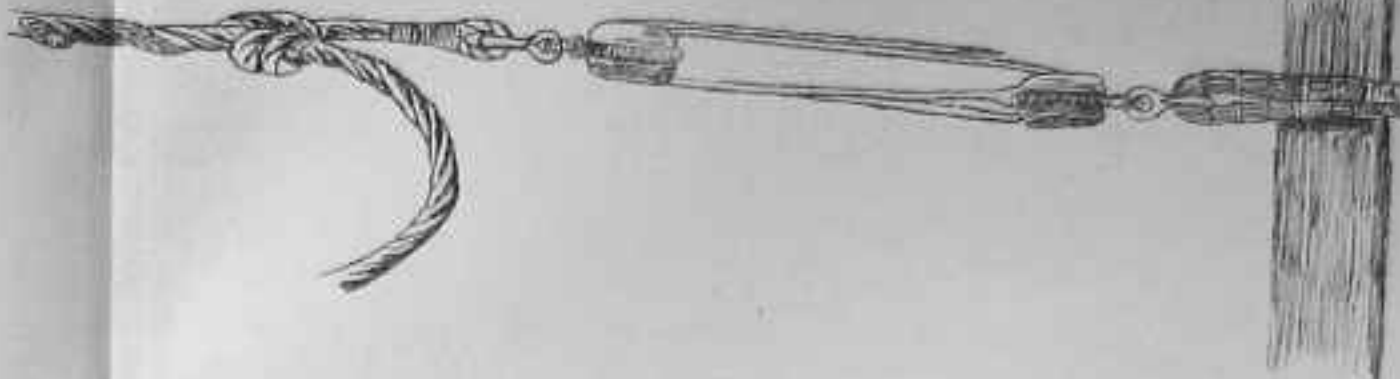

742



743

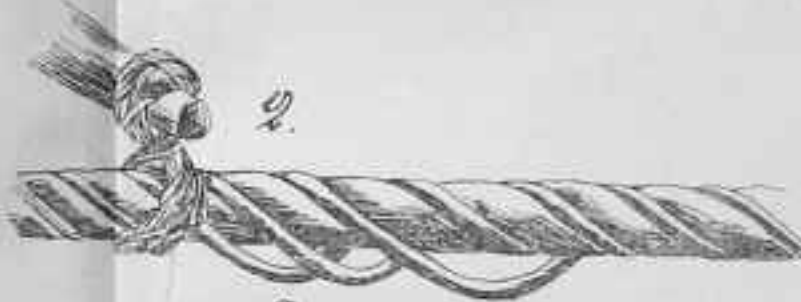

2.

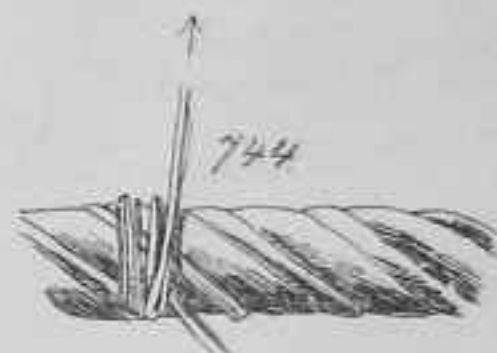

744

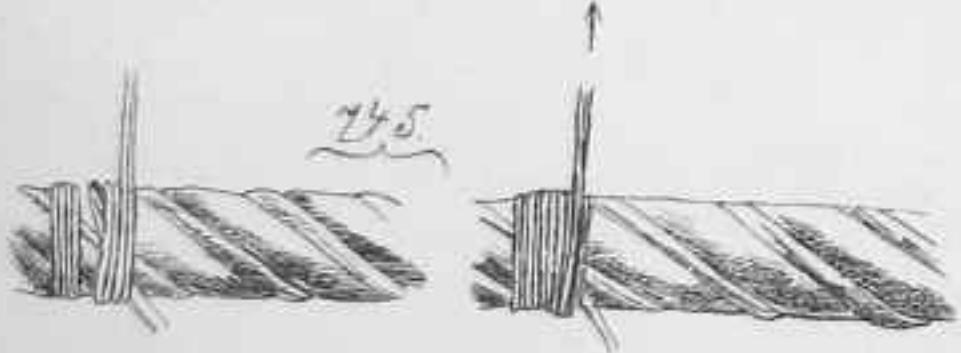

745

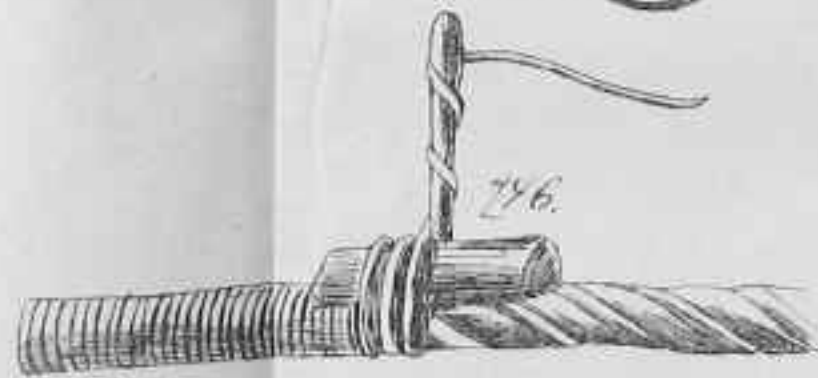

746

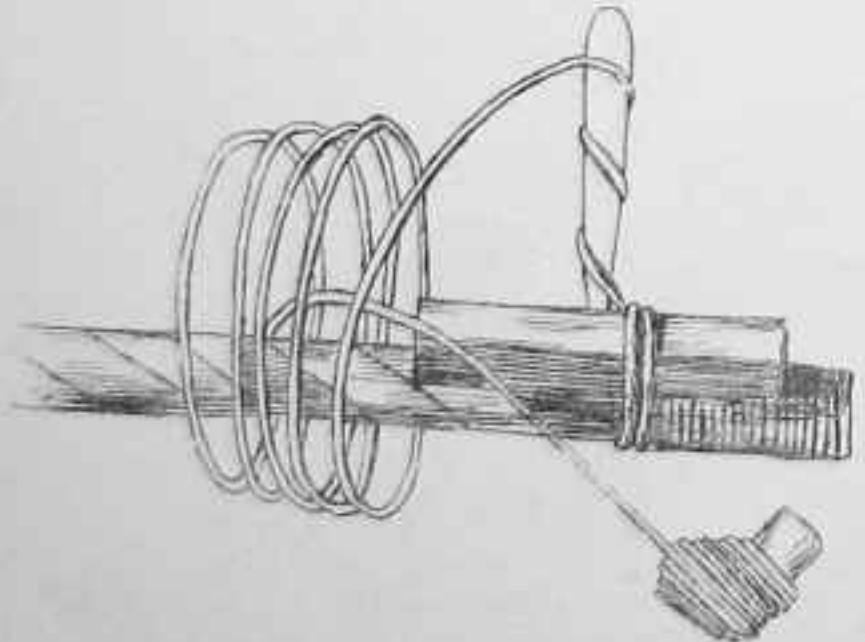

747

Plan for Copiers

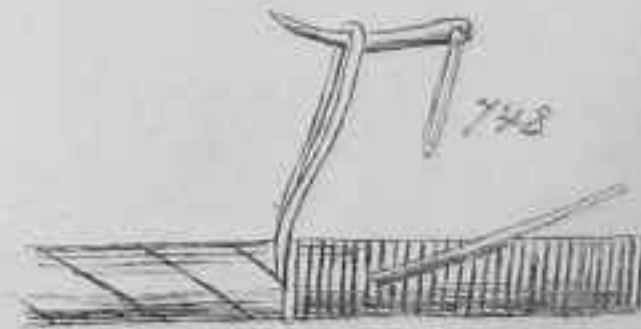
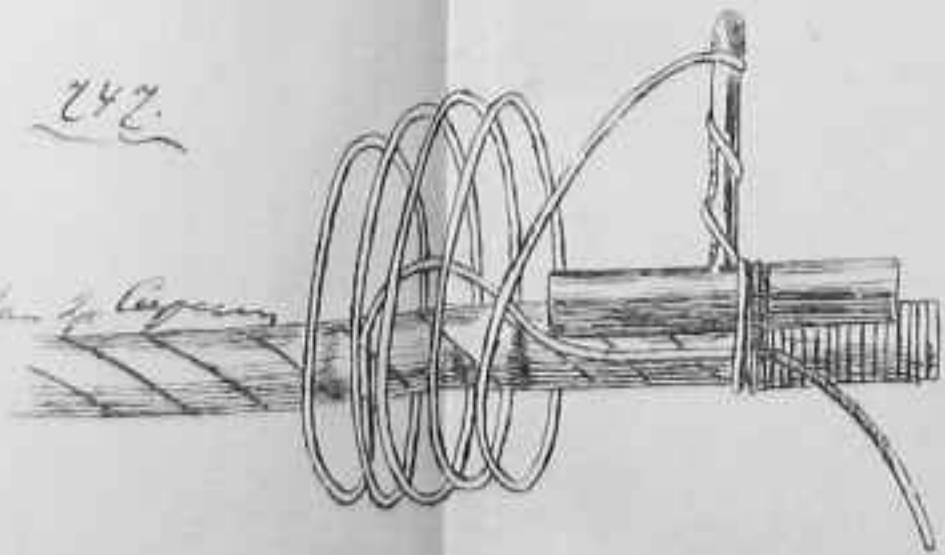

748

749

Table 100

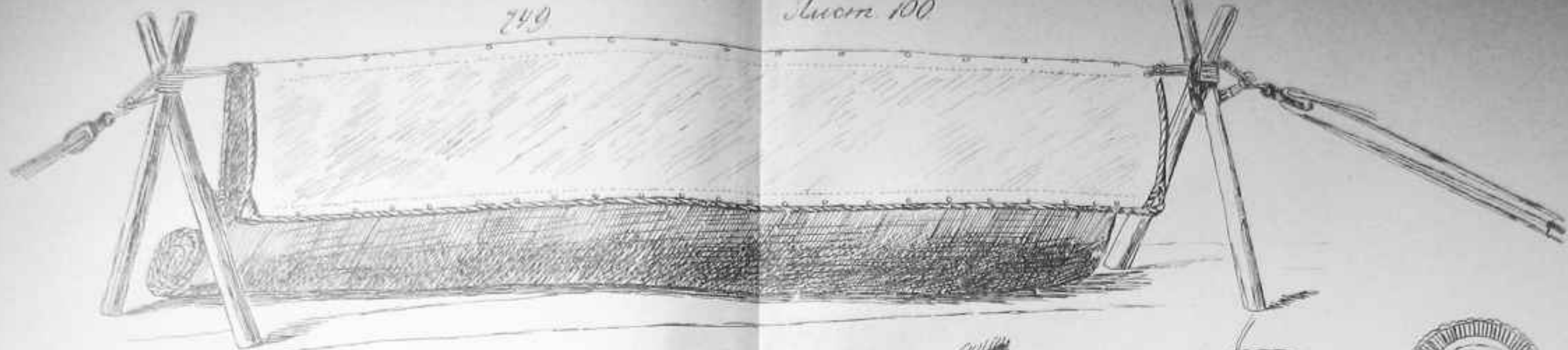

750

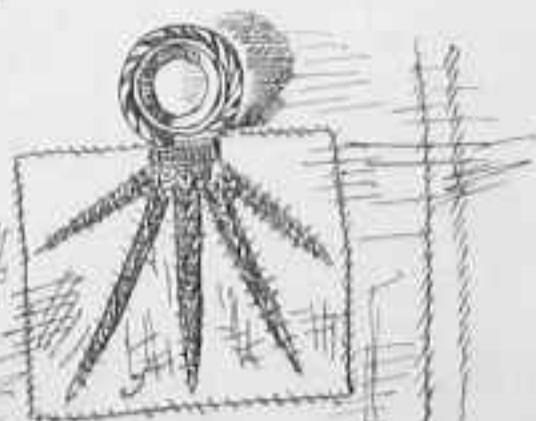
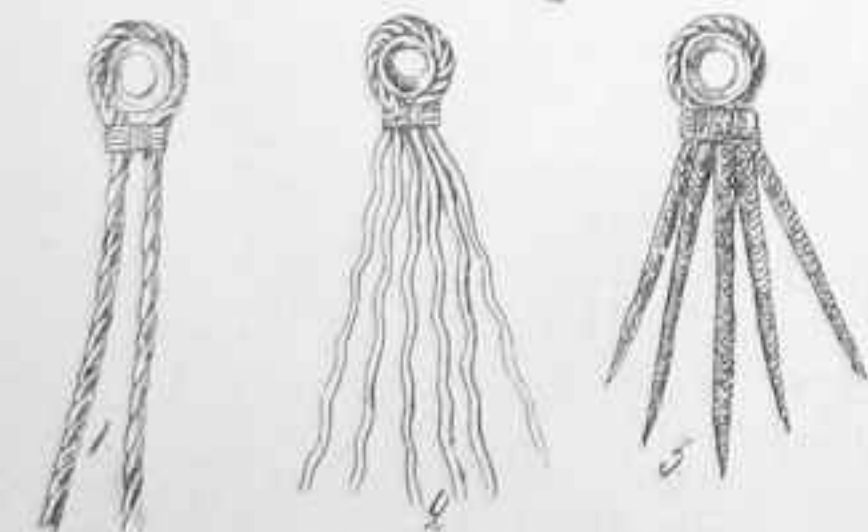
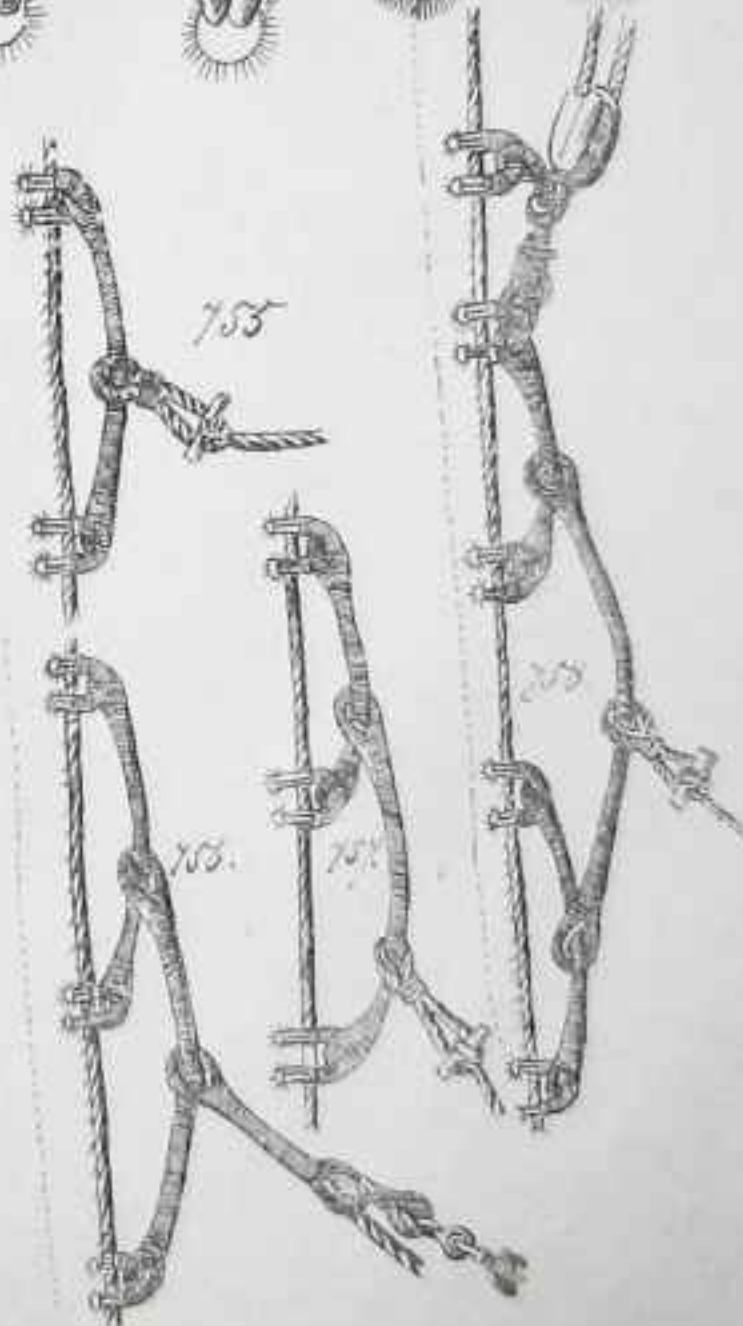
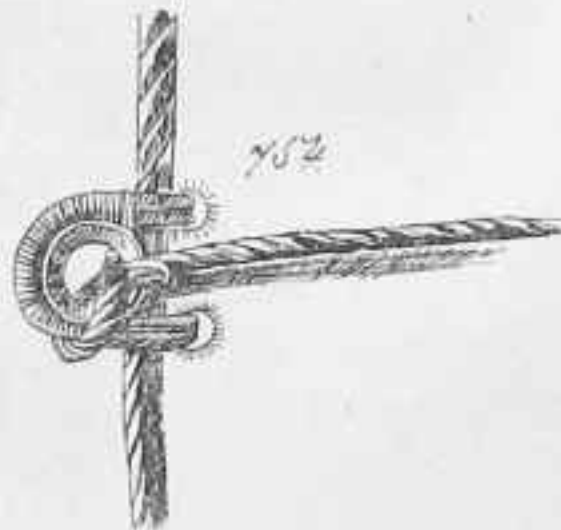
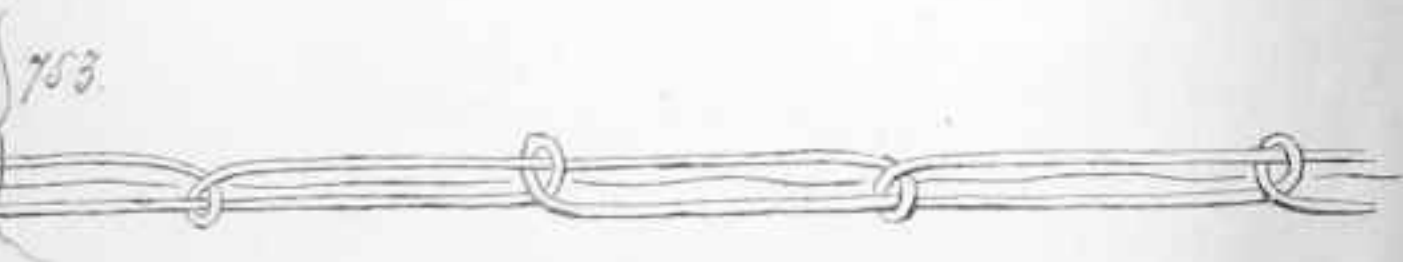
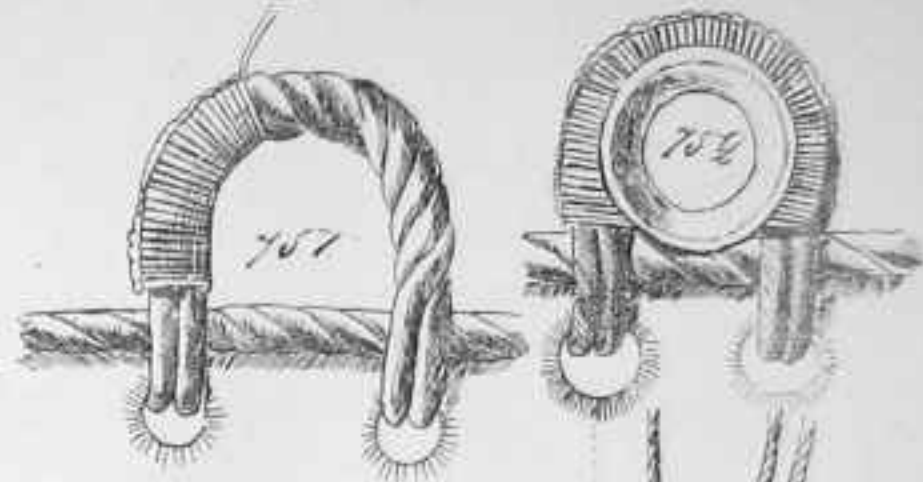

759

Table 100

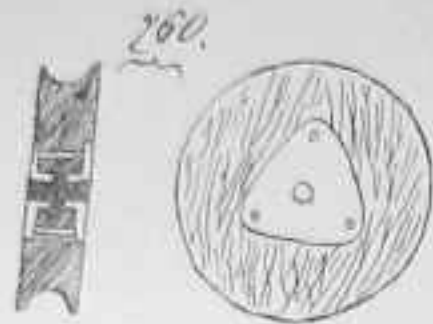
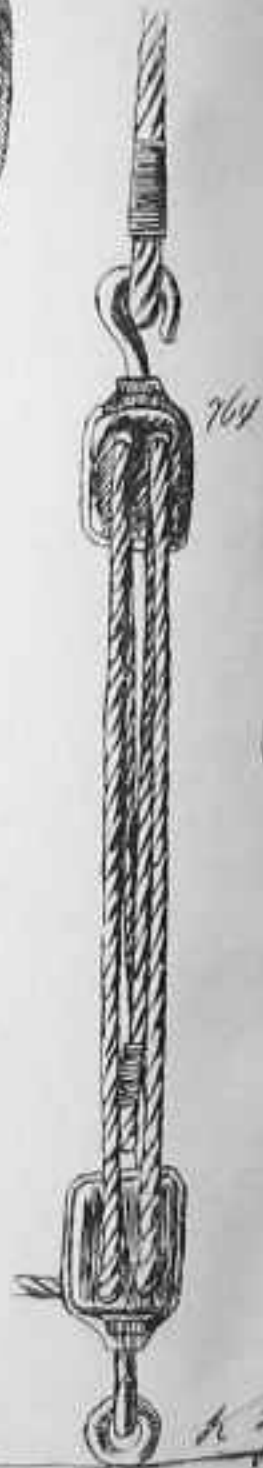
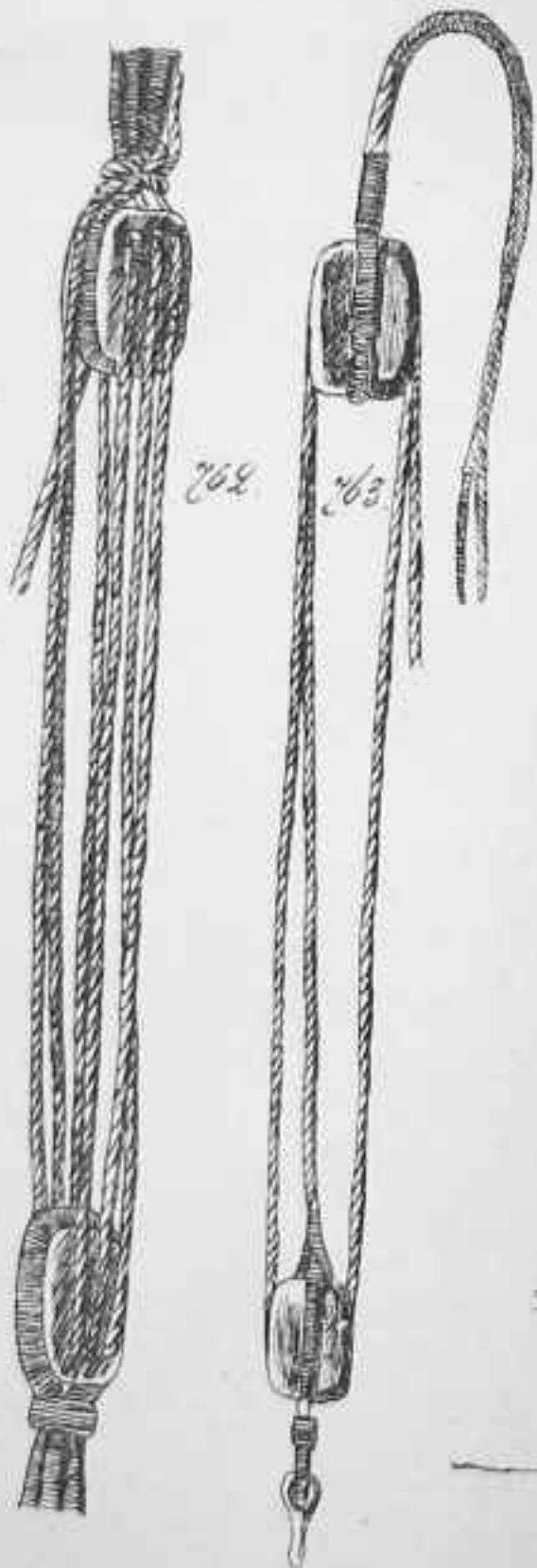

Success. 101

265

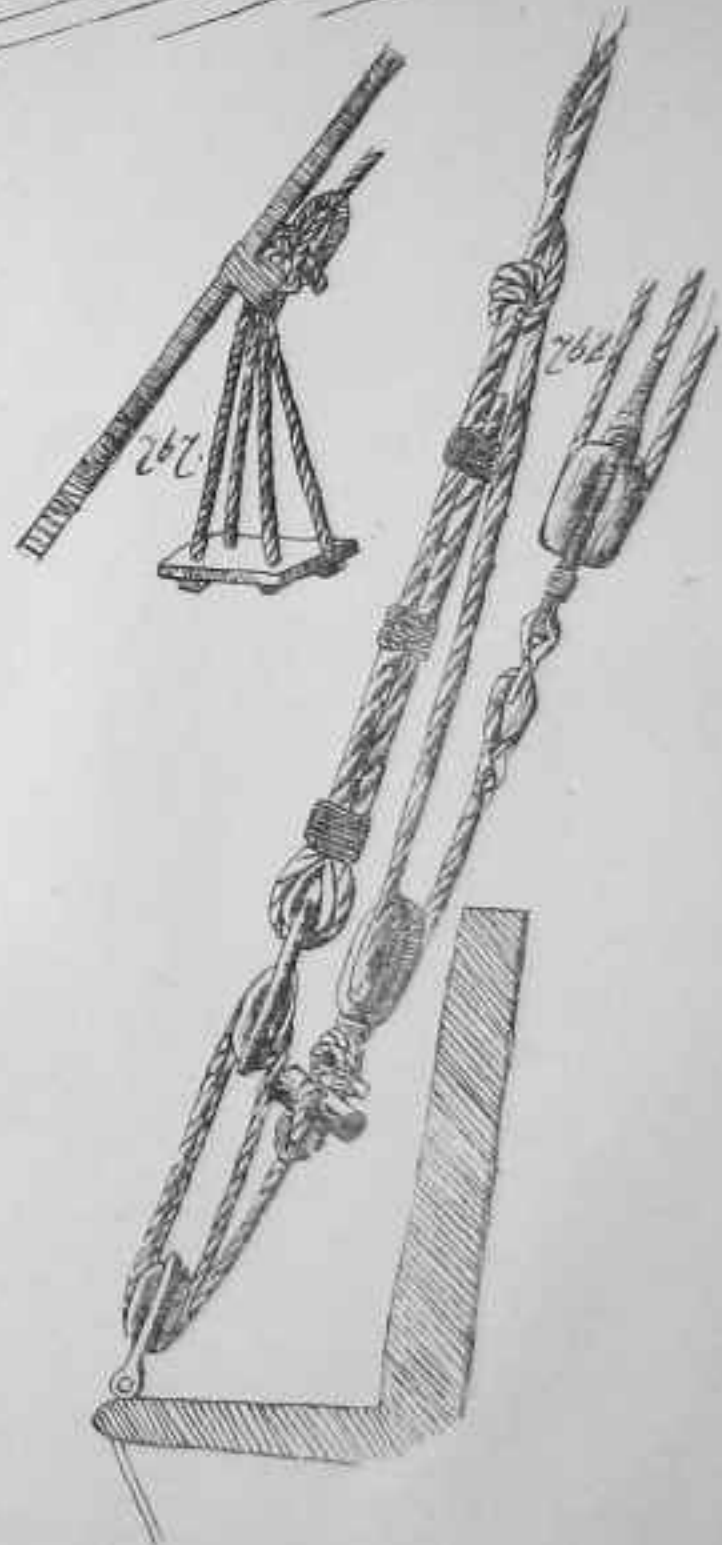
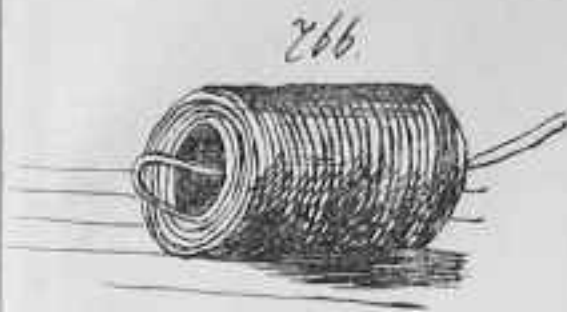
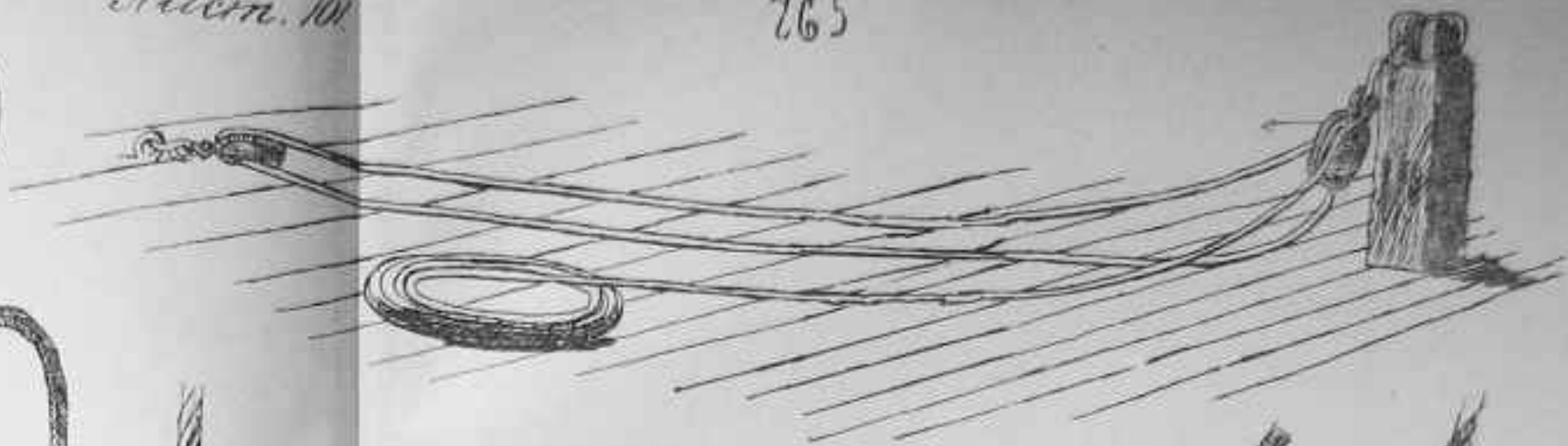

A. L. C. 101

Lucern. 10%

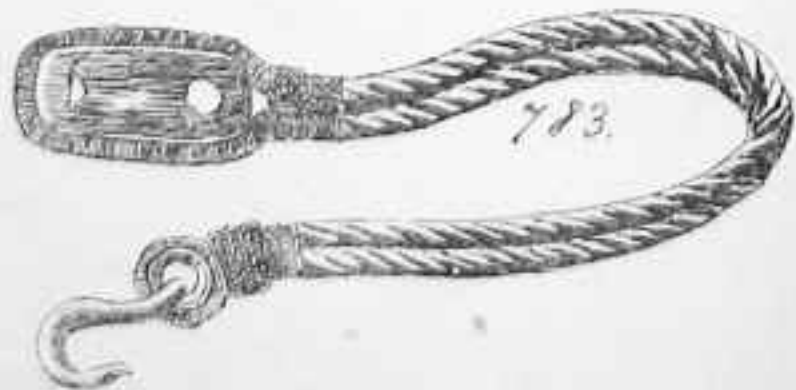

H. G. L. L. L. L.

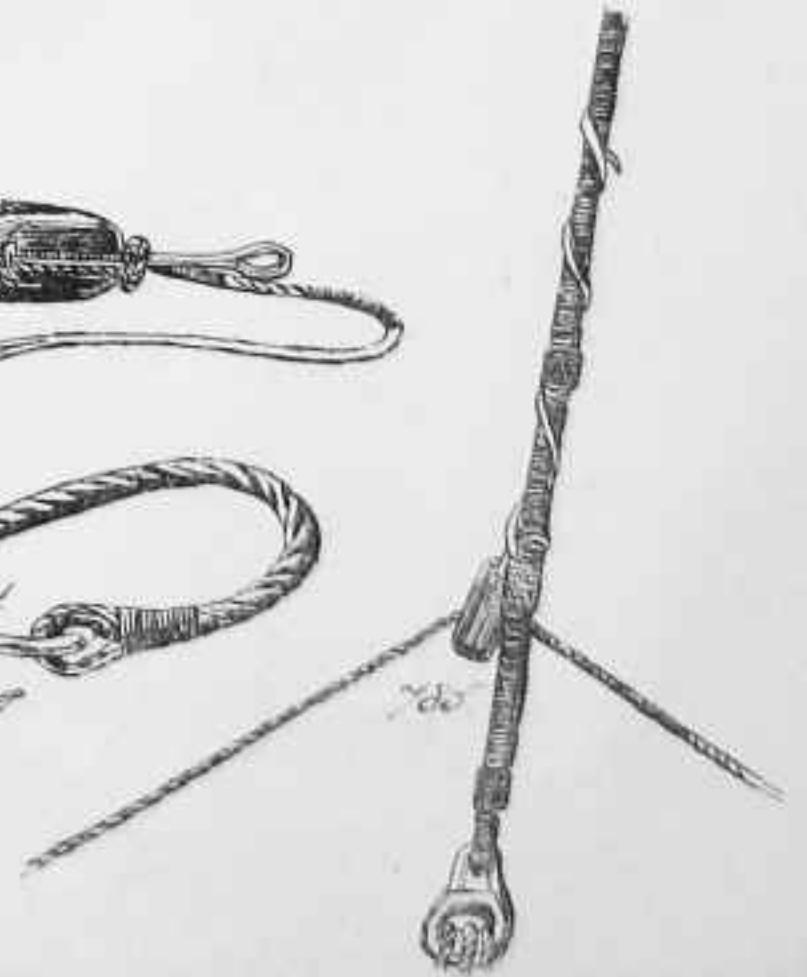

Lucr. 105

286

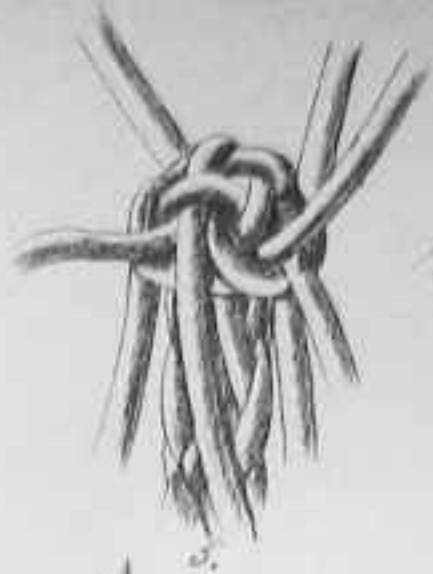
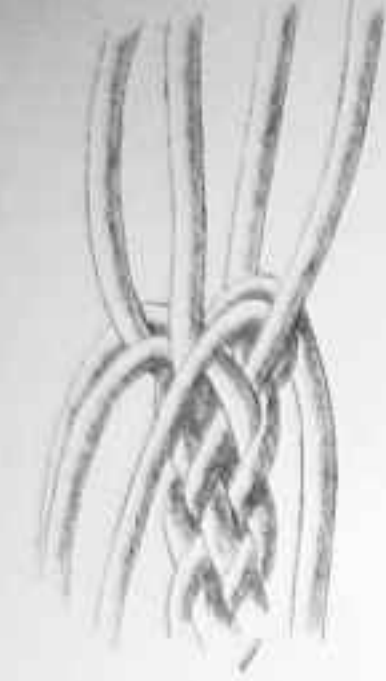

287



288



289



290



K. Z. G. G. G.



Ston 104



893

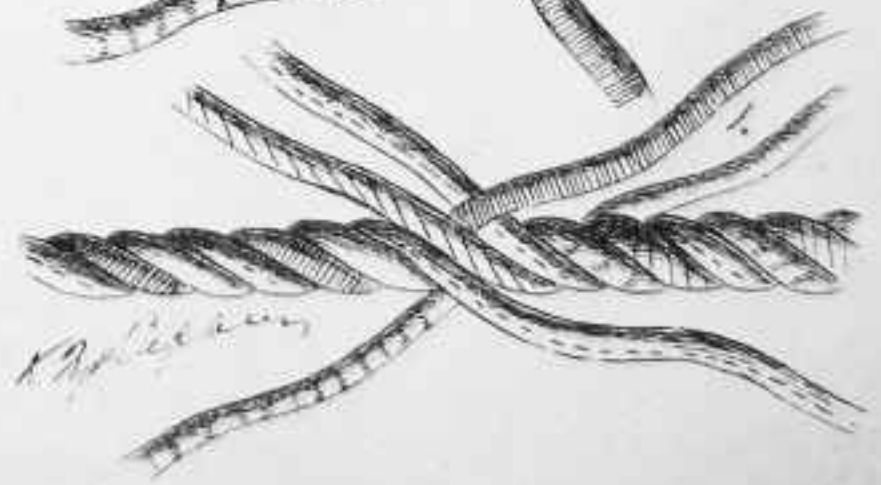
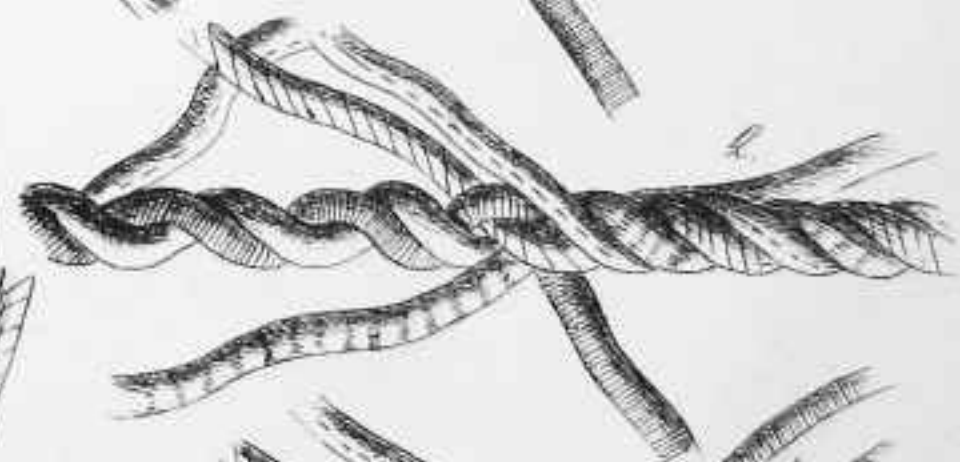
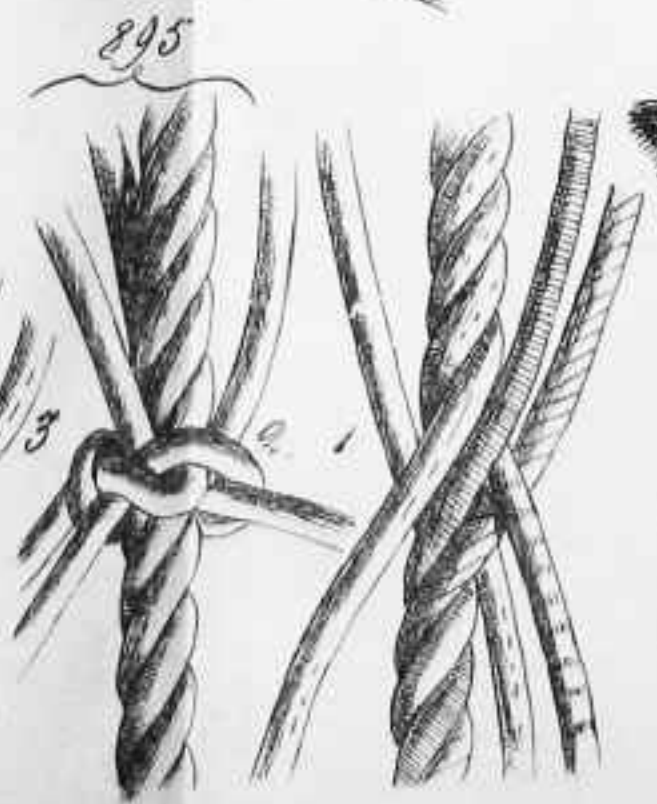
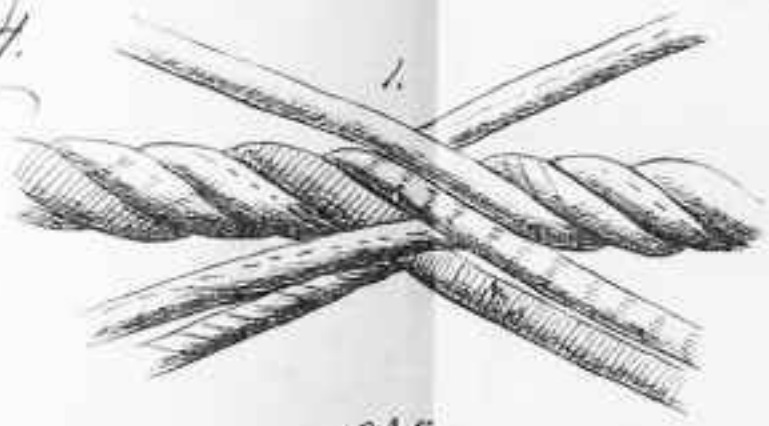

896

895

Polish

Tuon. 105.

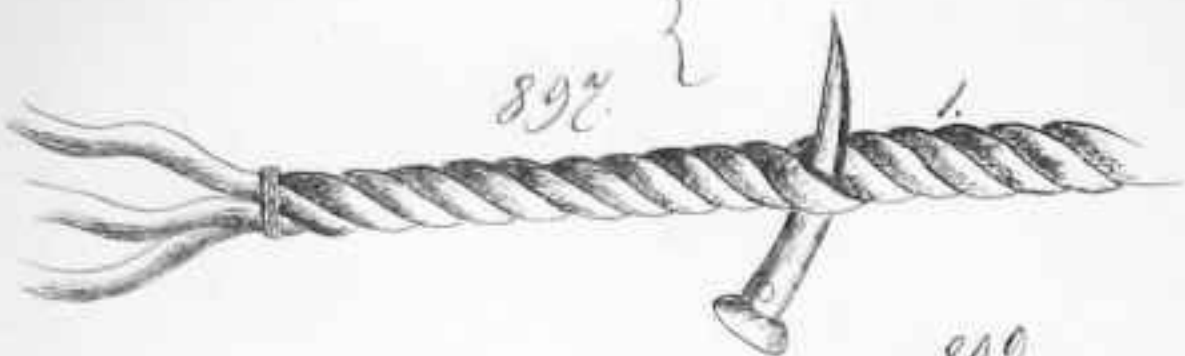

898



898.



By Regulus



901.



Das bequeme

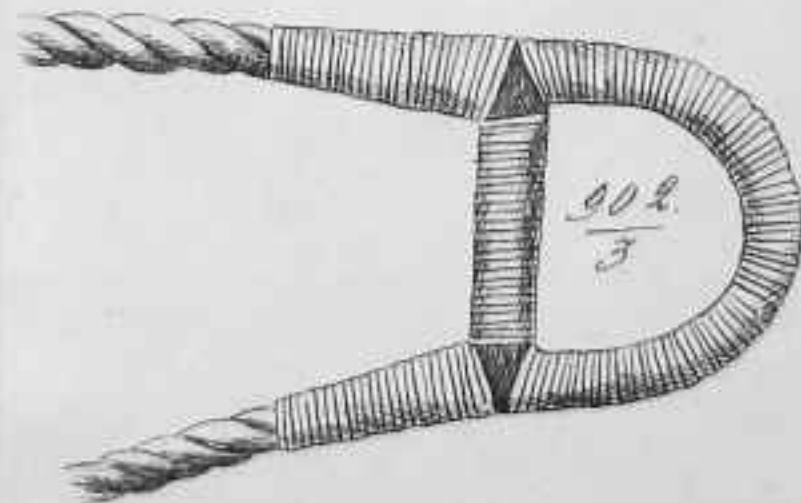

Stuerm. 107.
903.

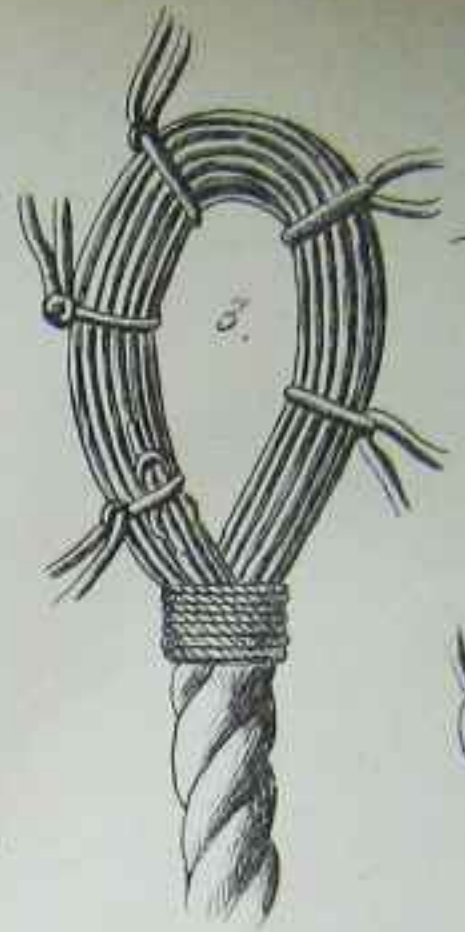
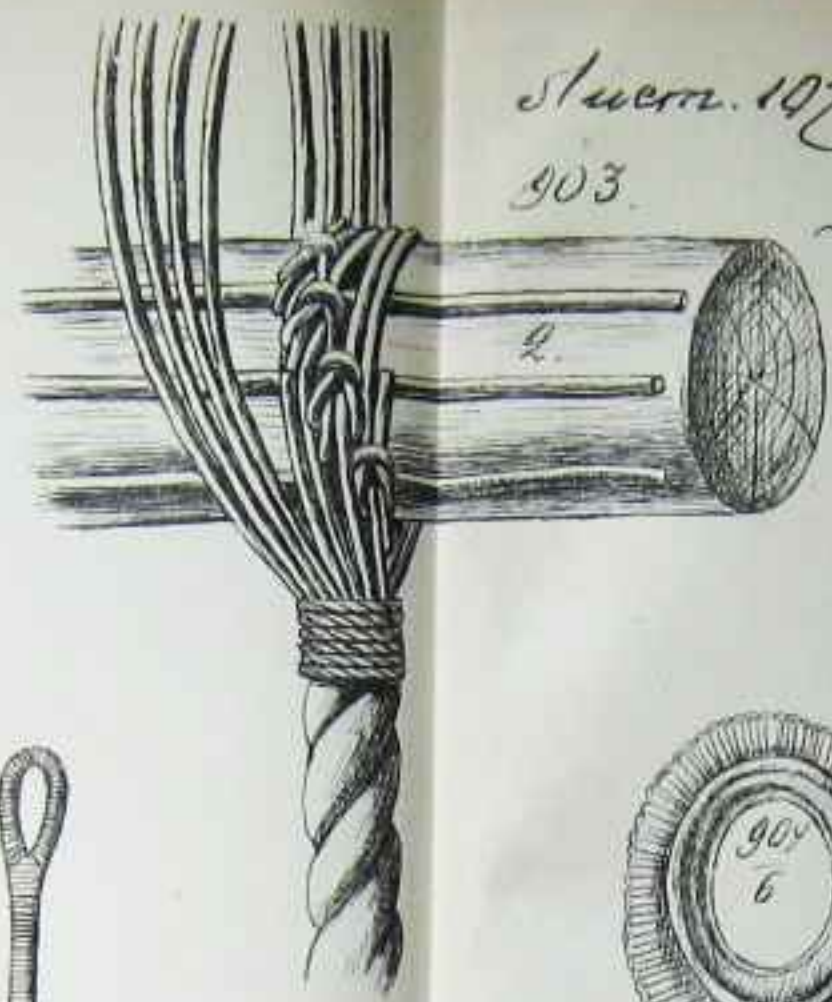
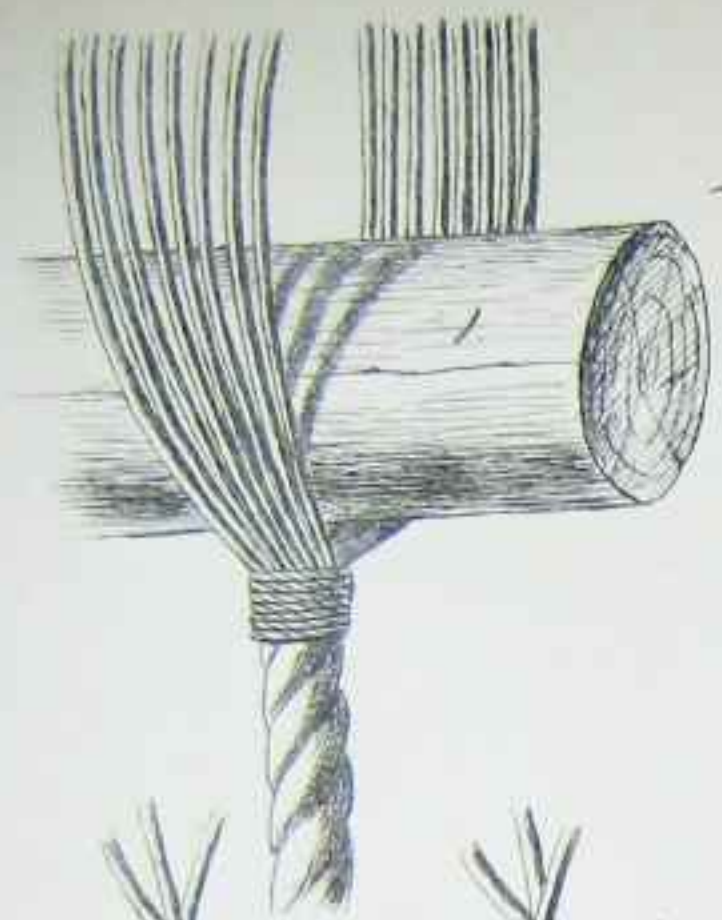

905.



904



904
6



904
2

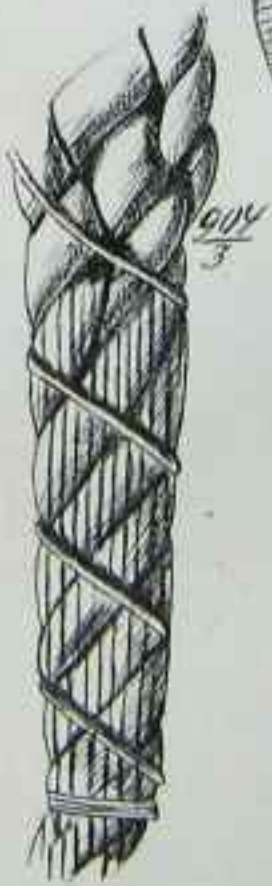

904
3

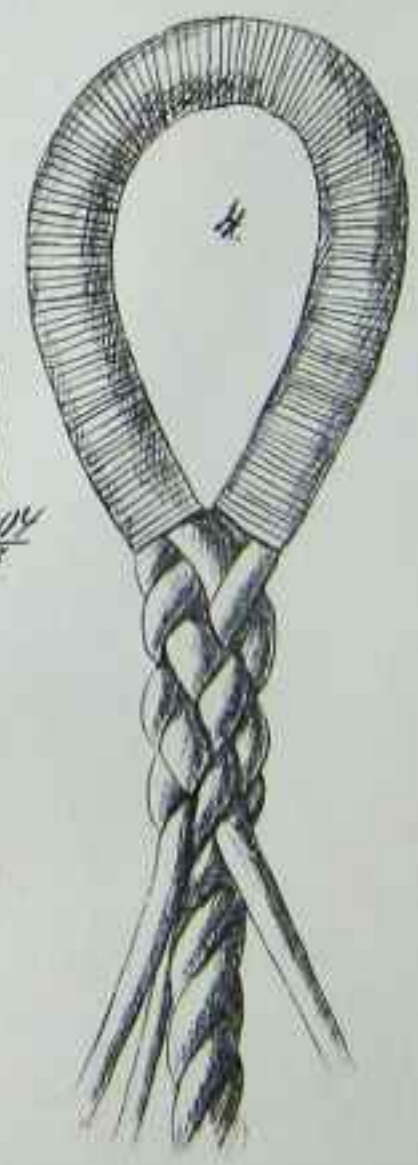

904

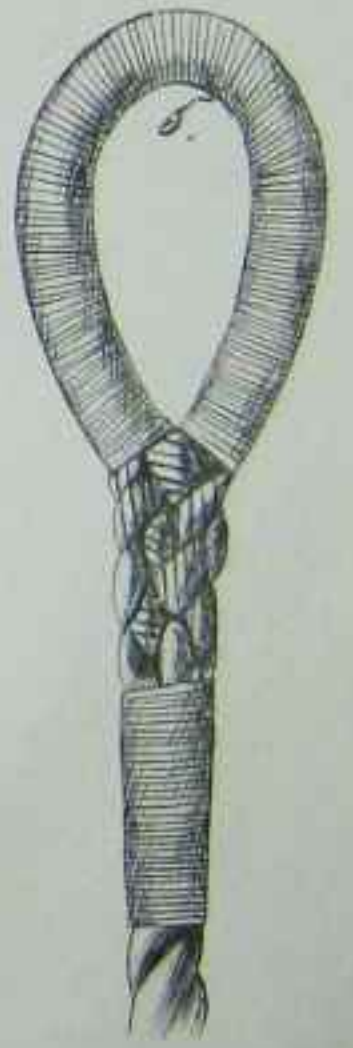

K. Z. C. ...

906

Stronn 108

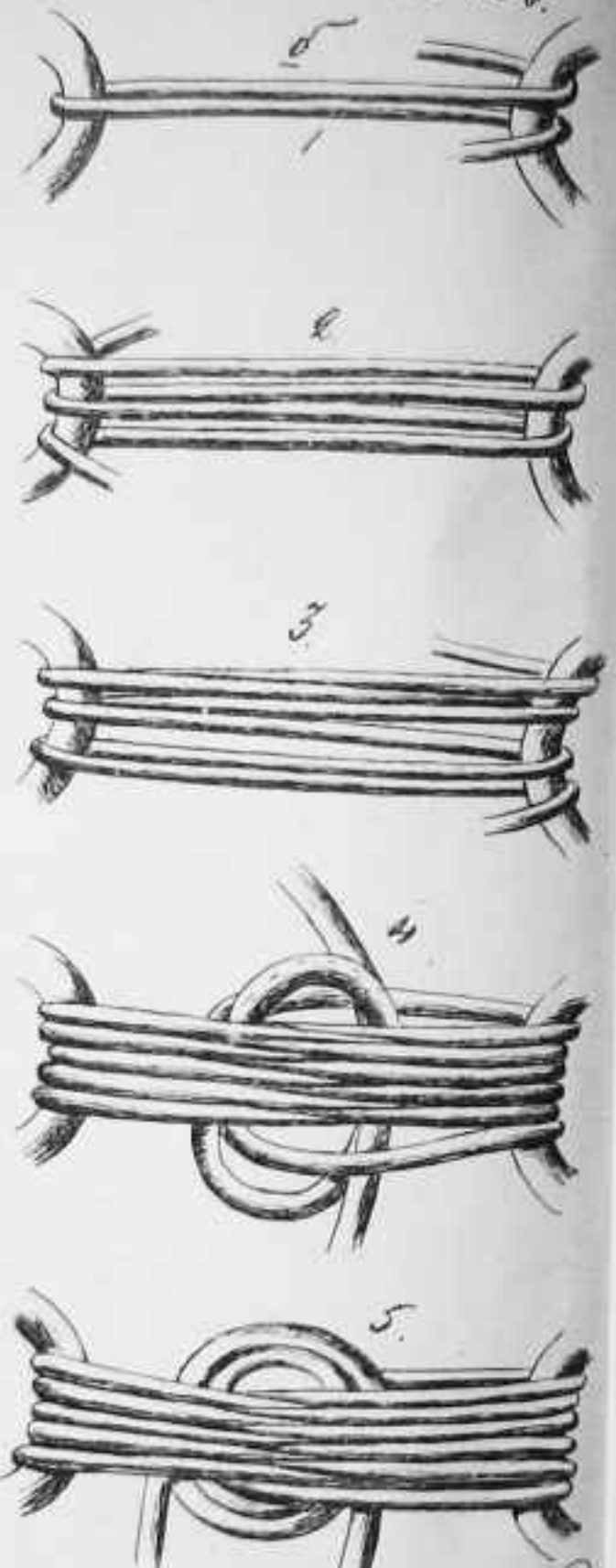
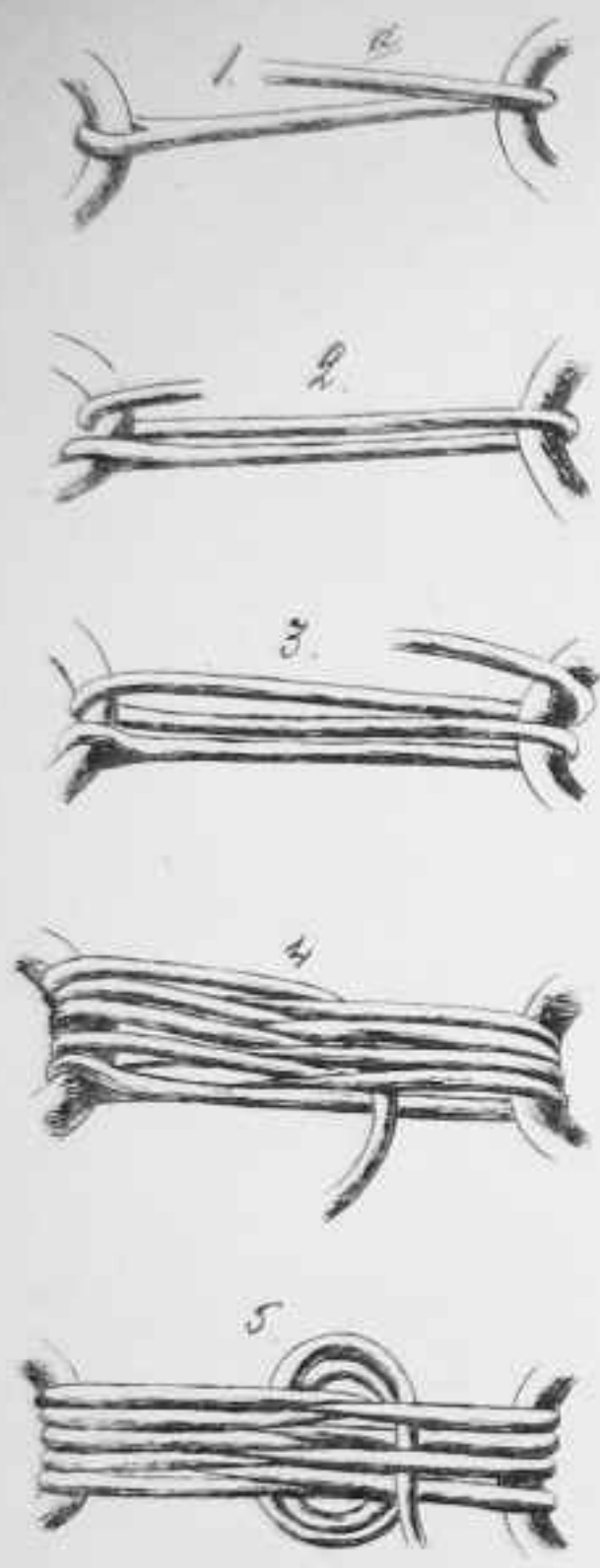

Handwritten signature or text at the bottom of the middle column.

907

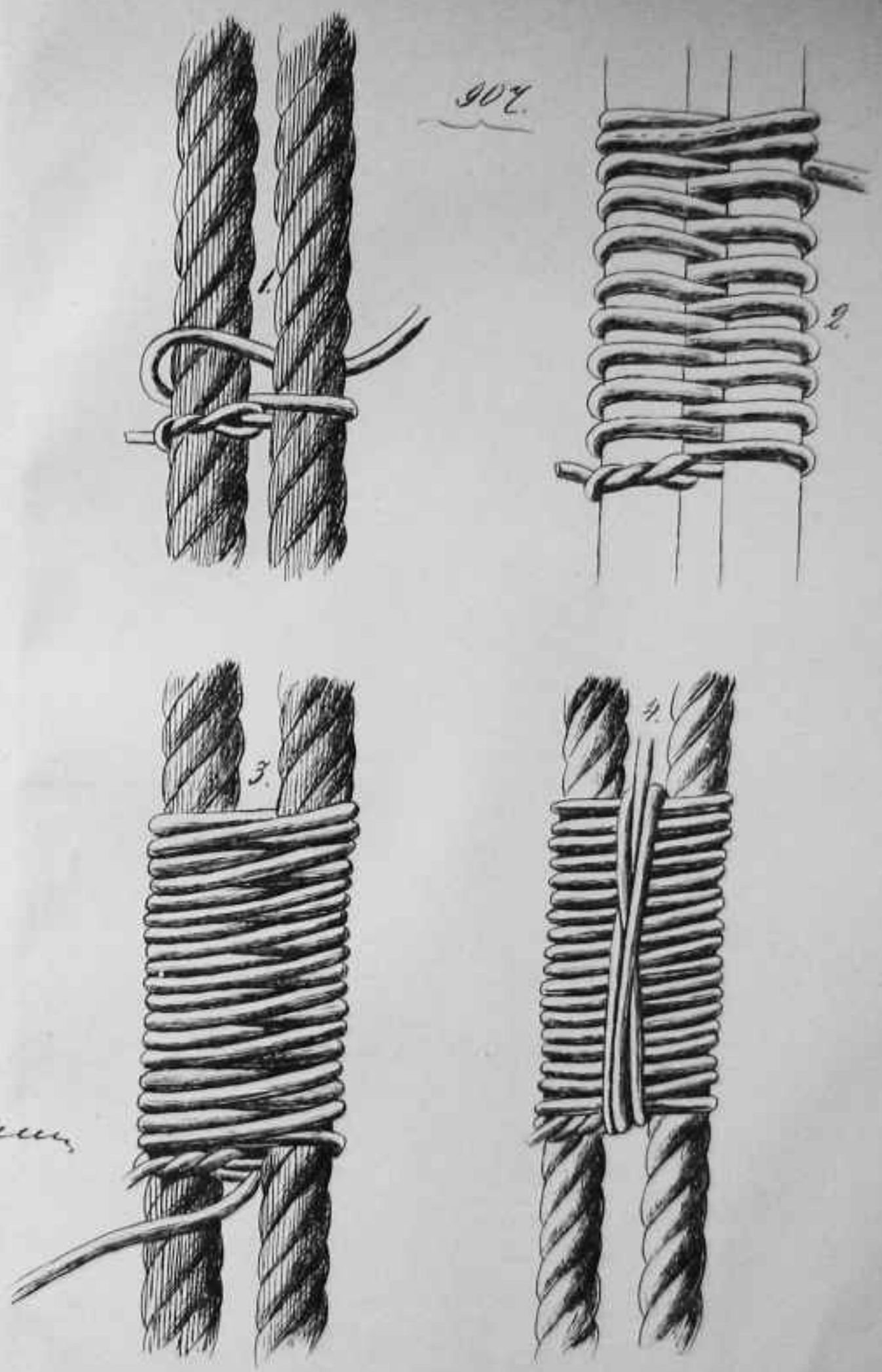

908.

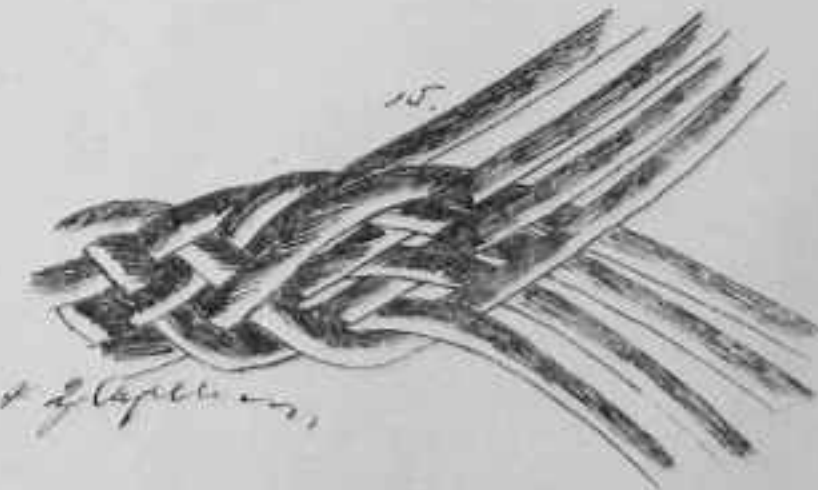
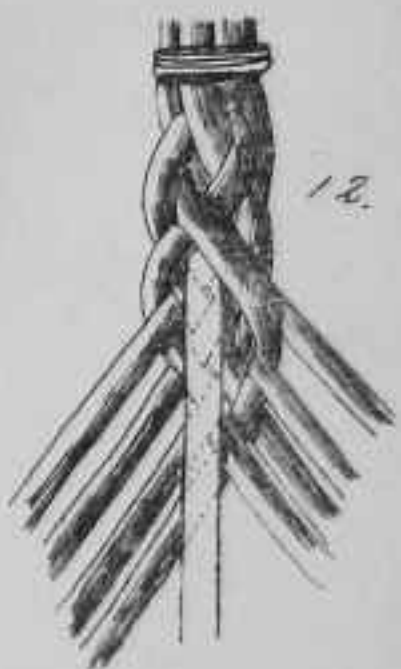
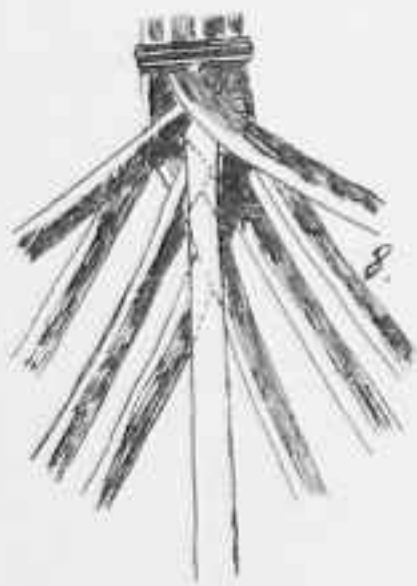
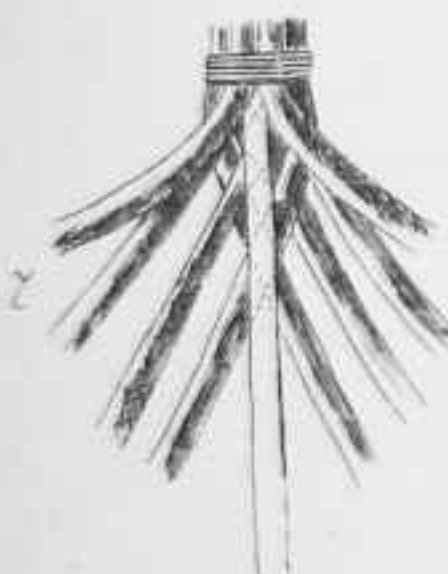
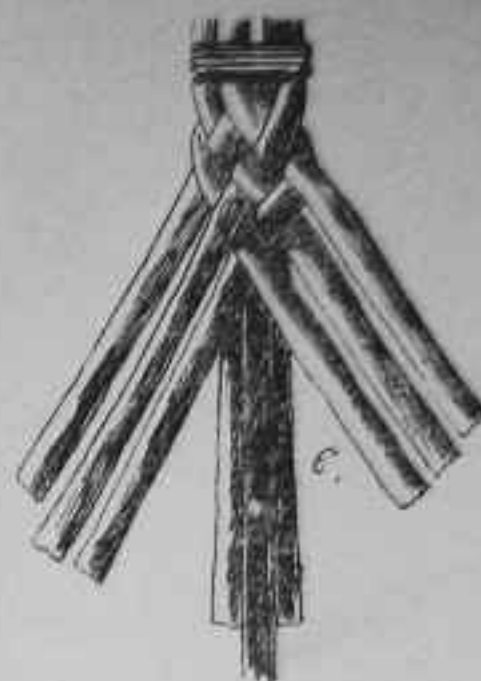
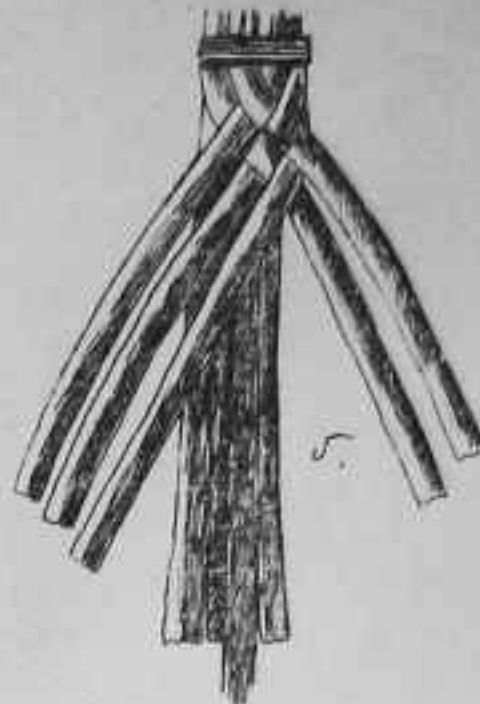
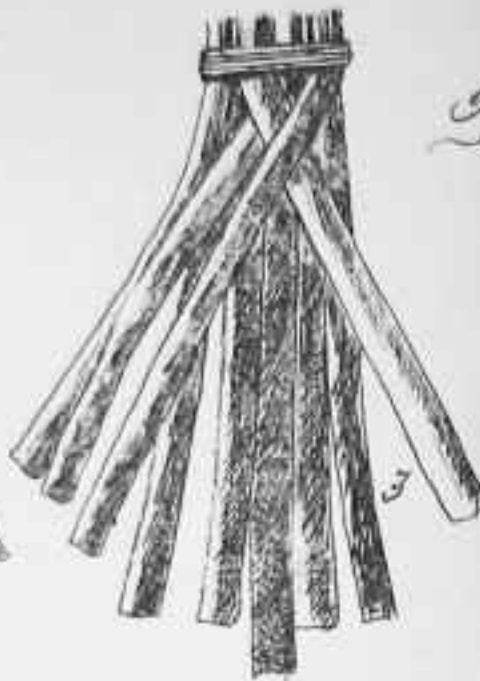
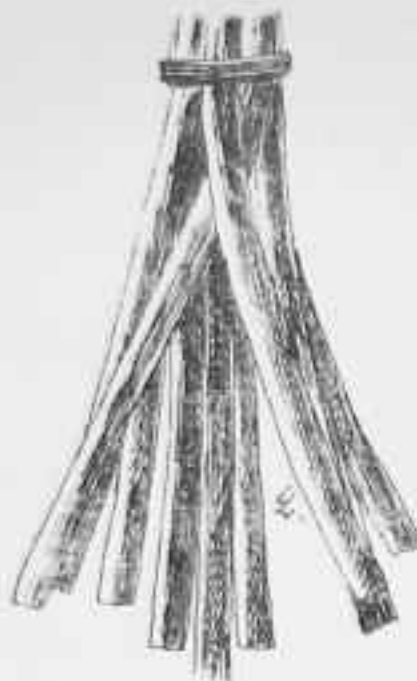

909.

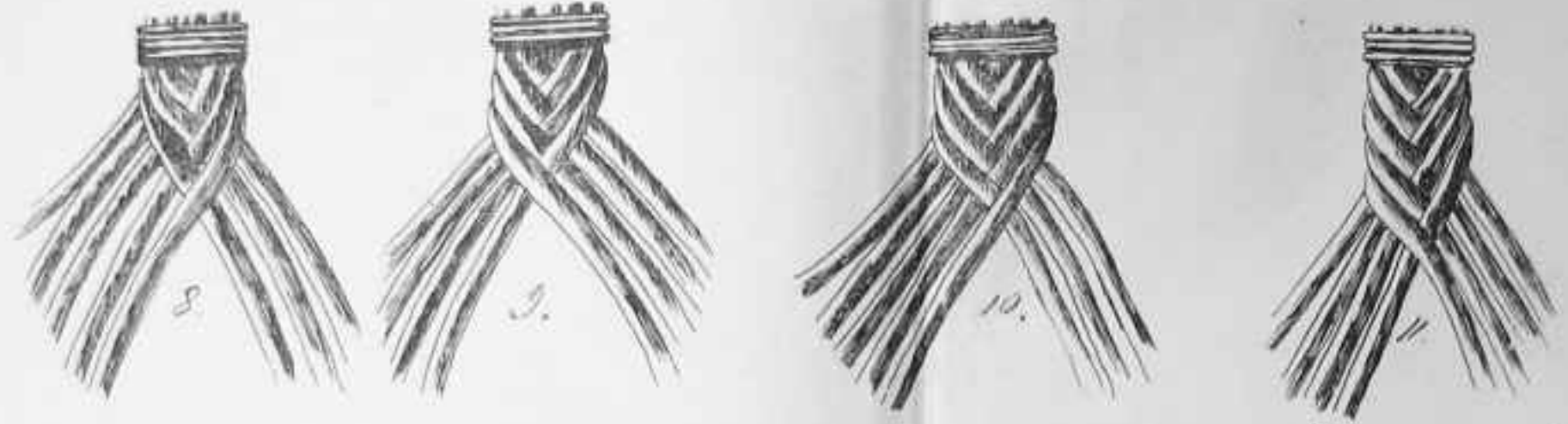
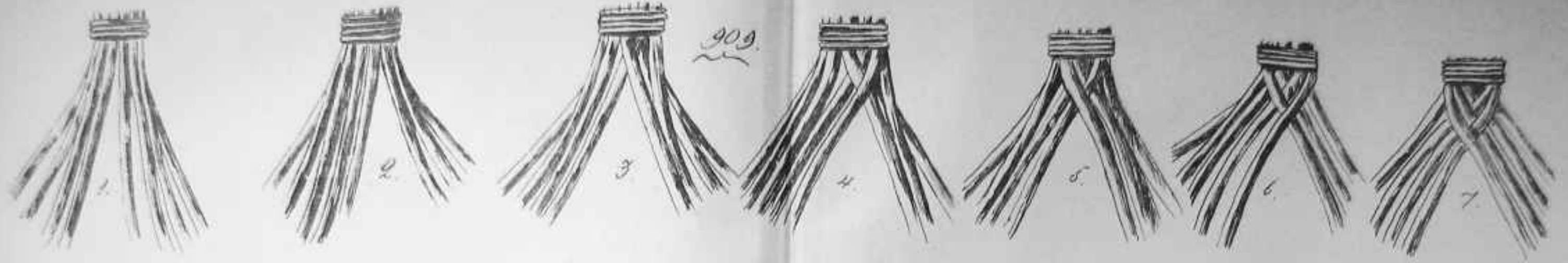

910.



Ed. Gyllen

310

Platte III.

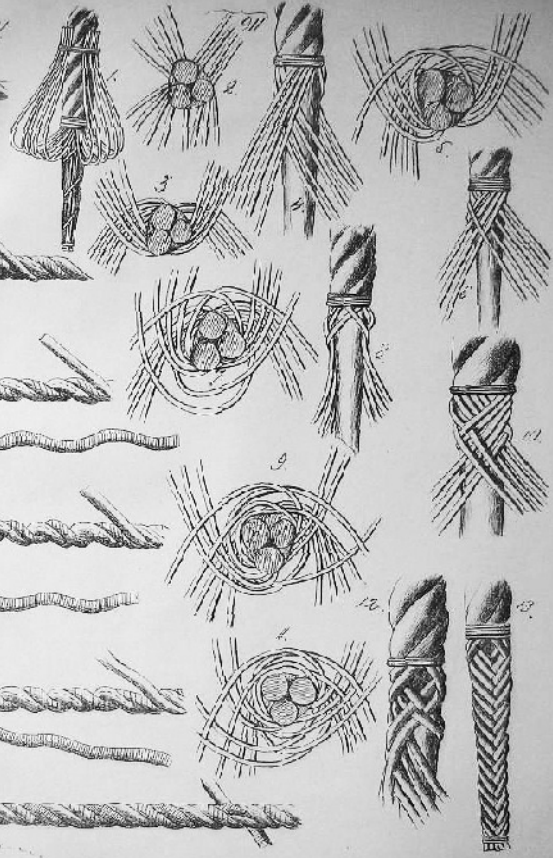

Handwritten signature or note at the bottom center of the page.

912

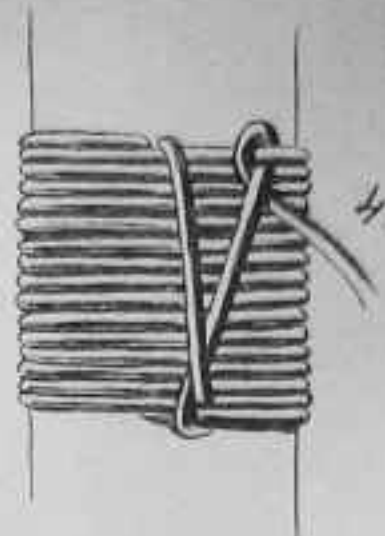
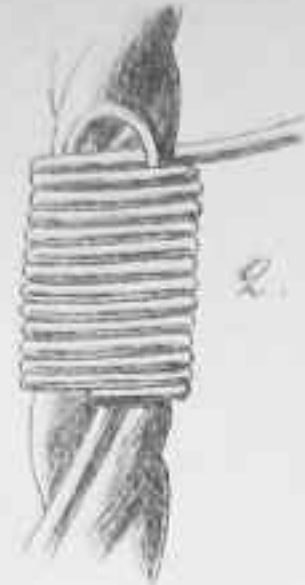

913



914

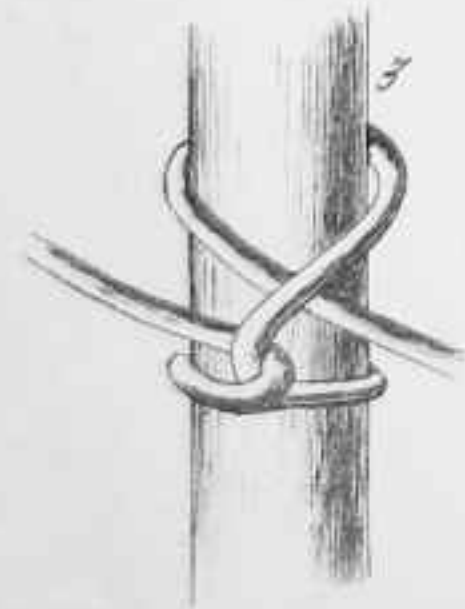
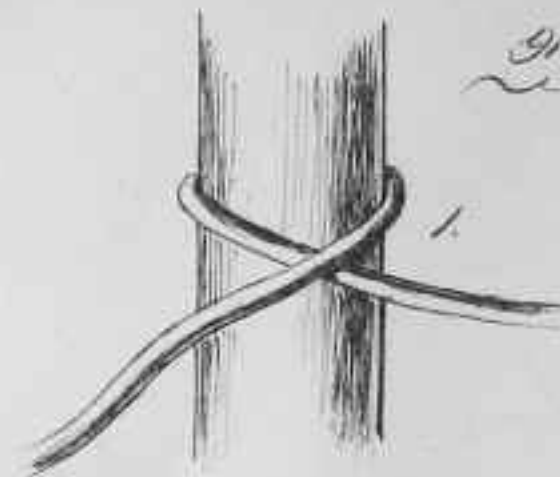

W. G. L. G.

Tuerre 113.

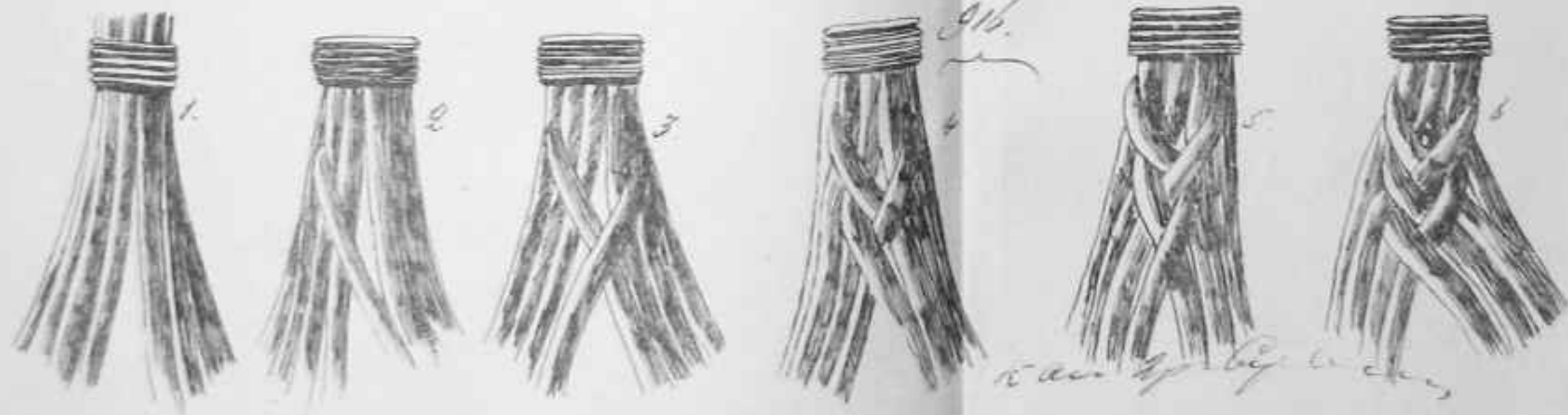
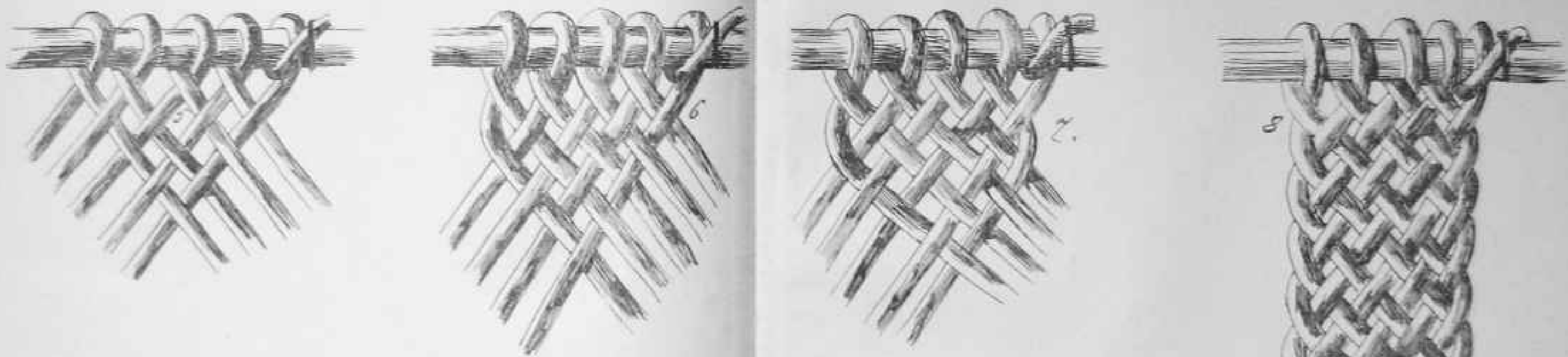
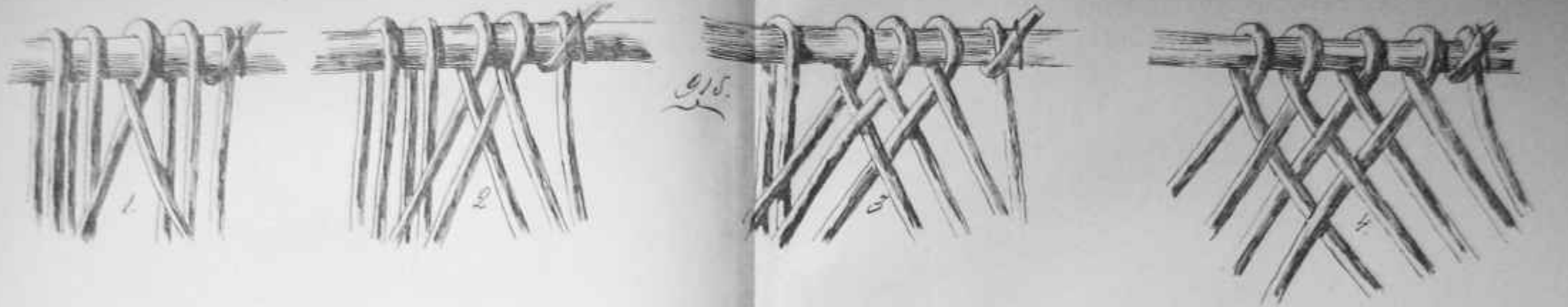

van der bijl. 113.

Sturte. 114



917

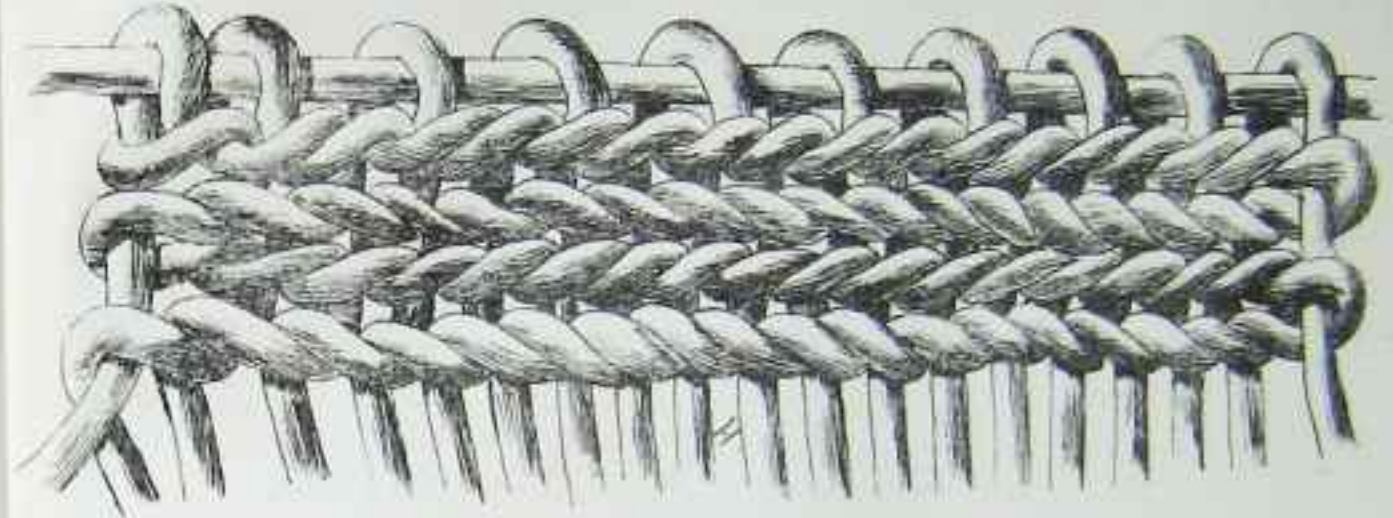
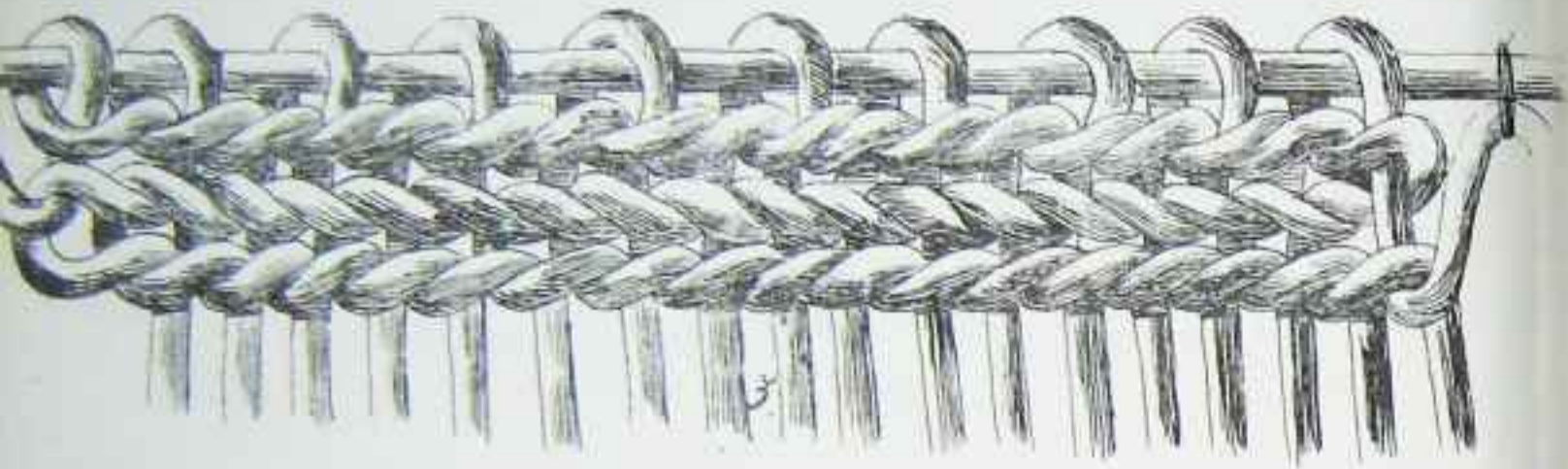
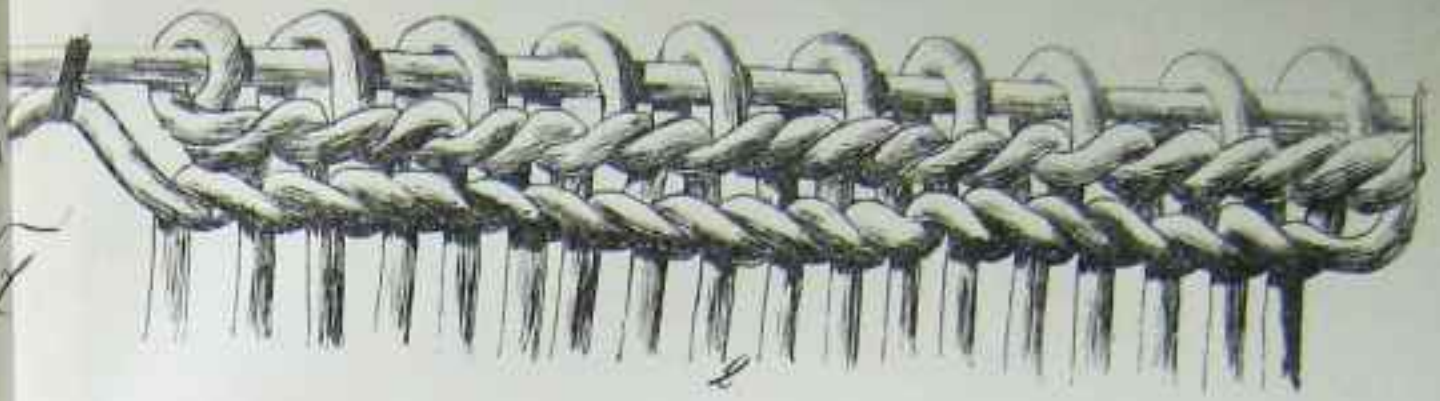

918

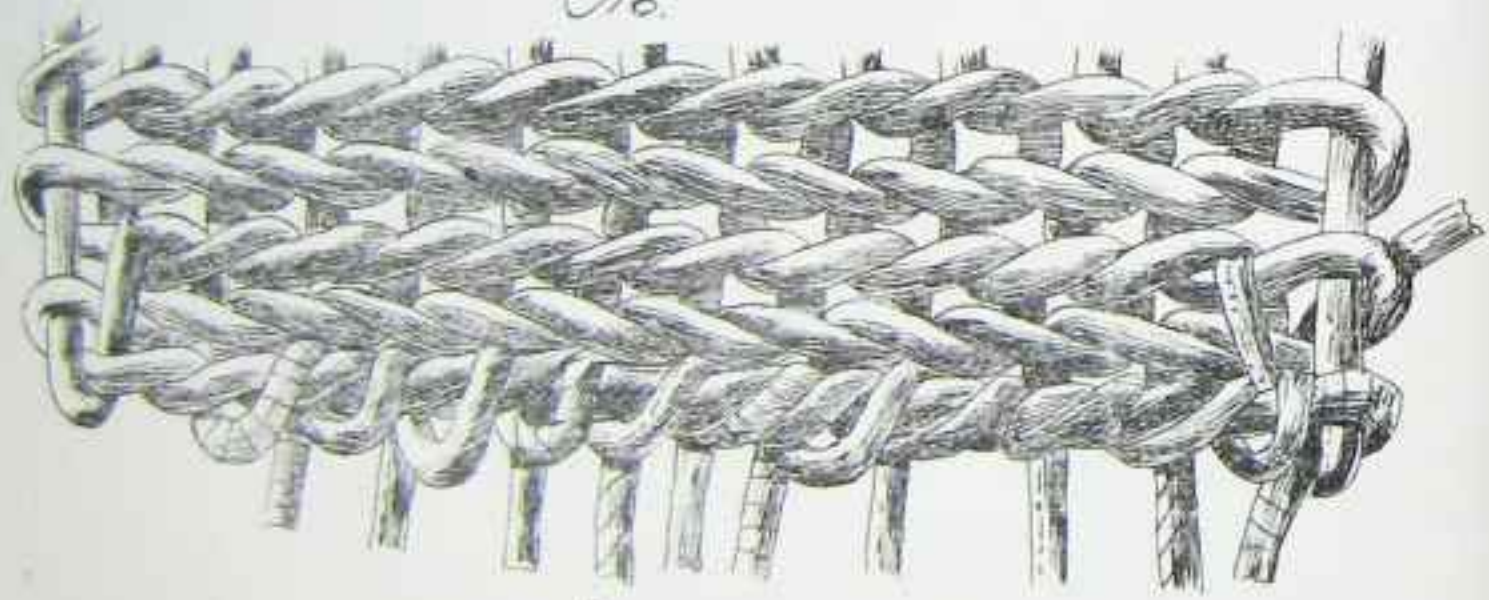

6



H. Type Rope & Lines

919

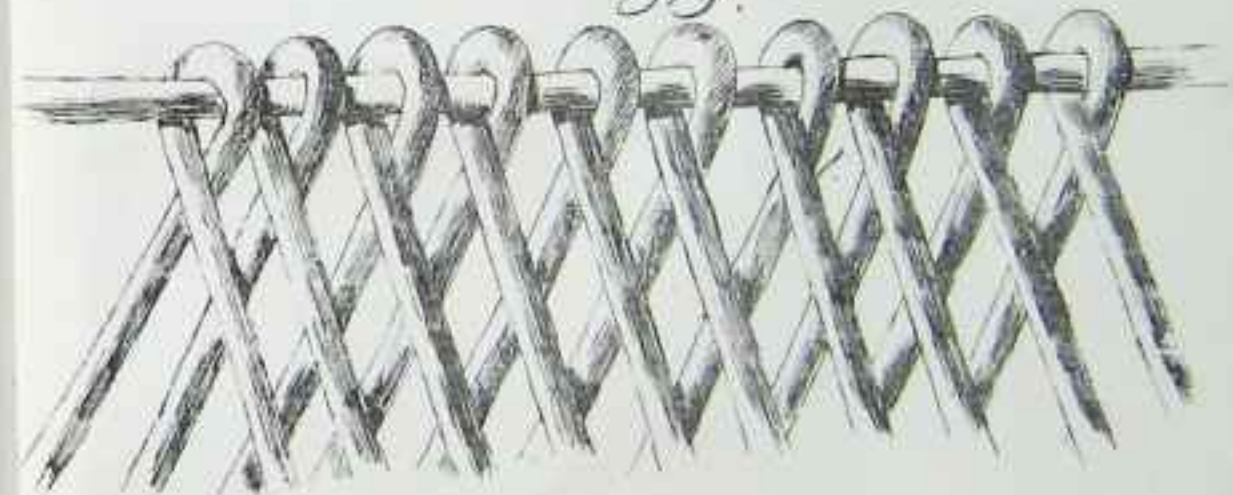

920.

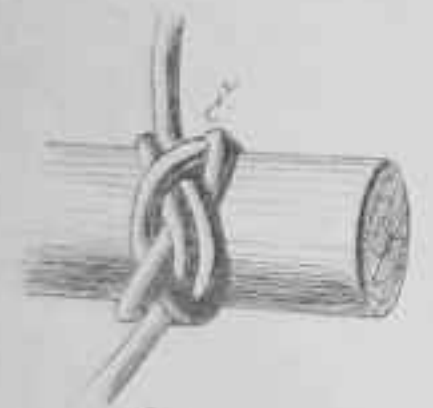
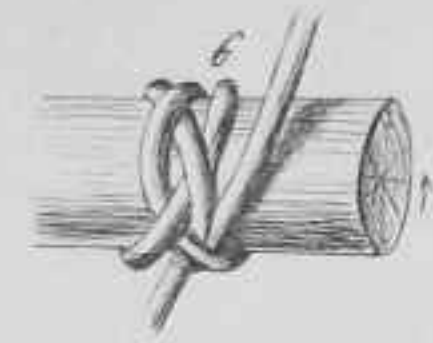
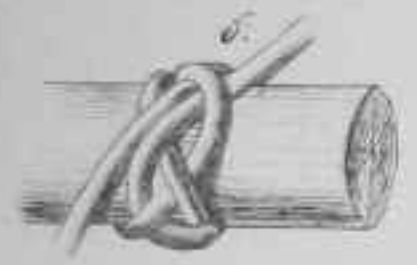
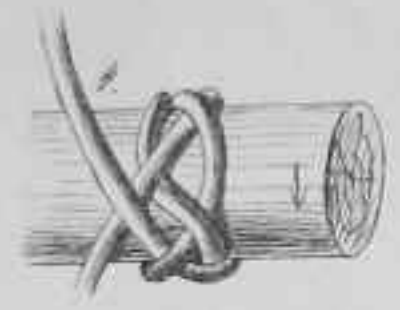
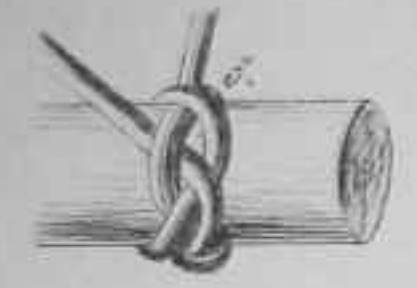
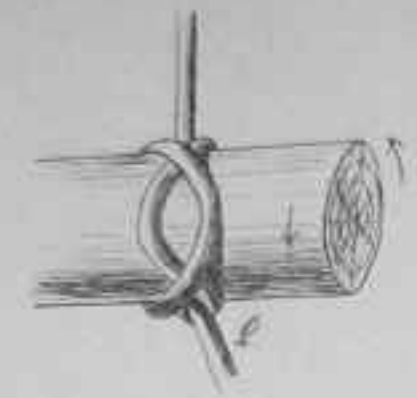
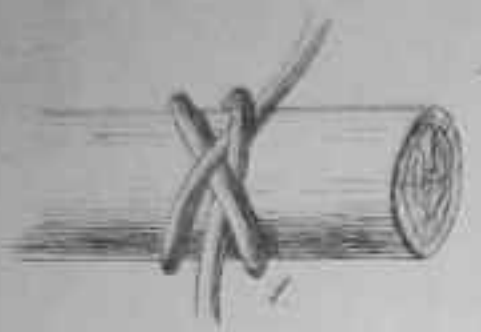

923.

Kangas Cylin



922.



921.



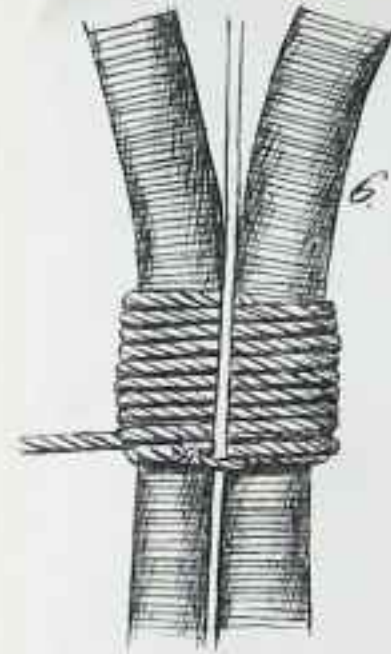
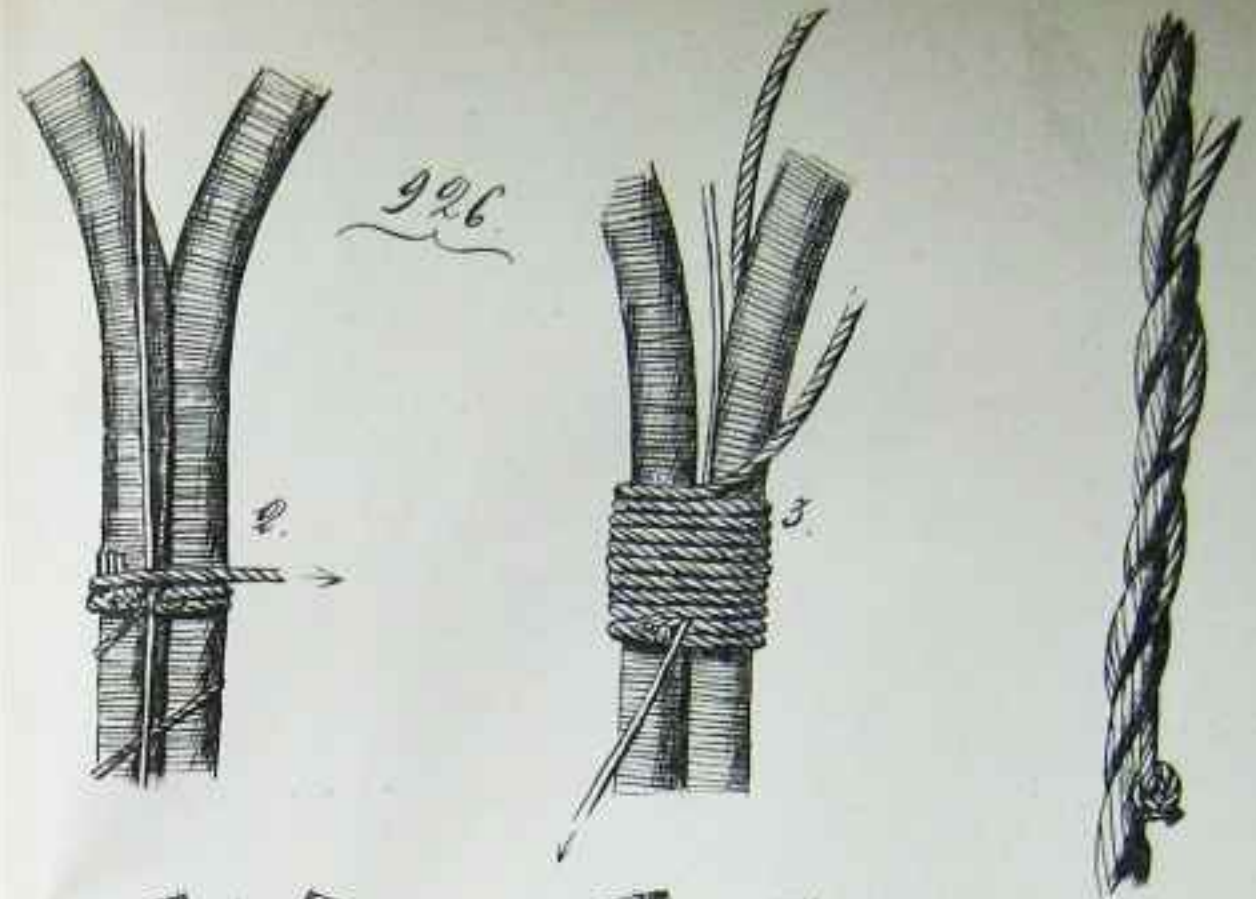
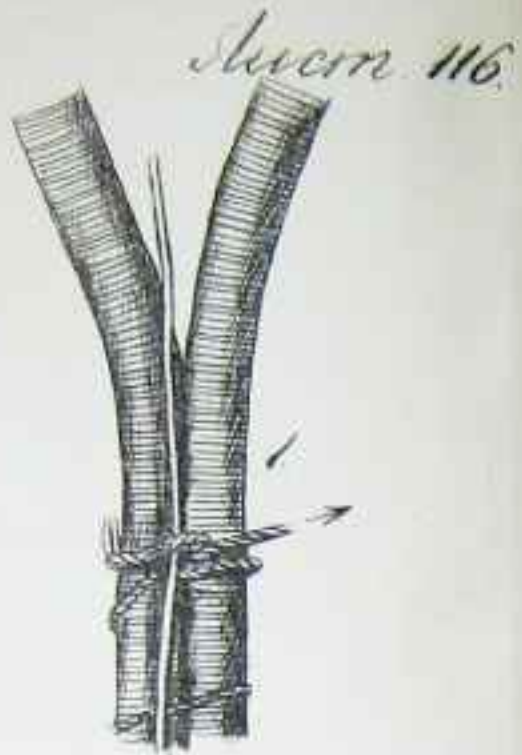
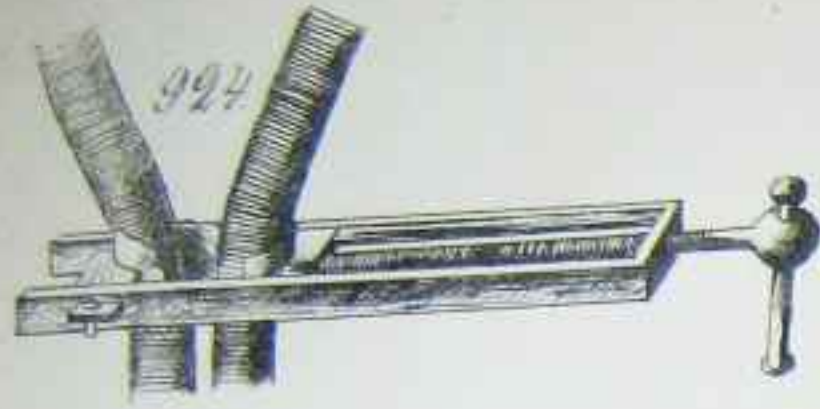

927

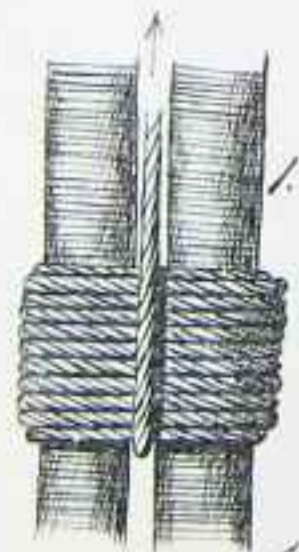

928



A. G. L. P. C. C.



929



Lucra. 117



930

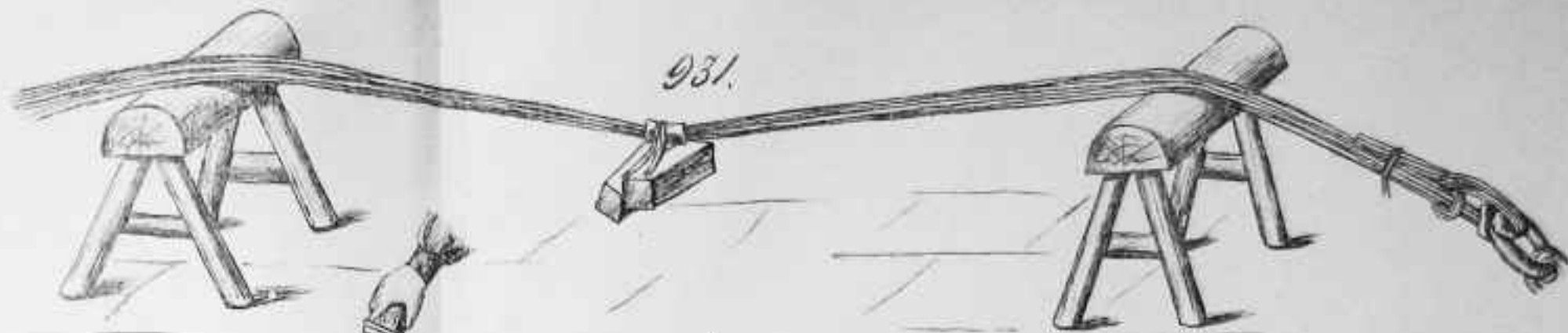

931



3

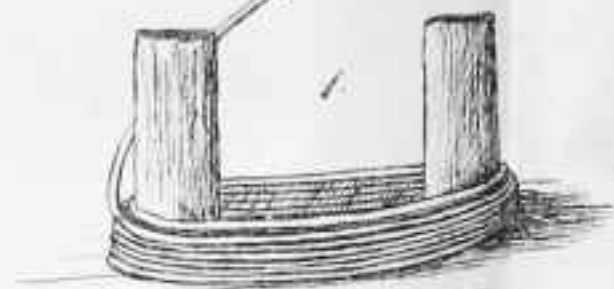

932



933

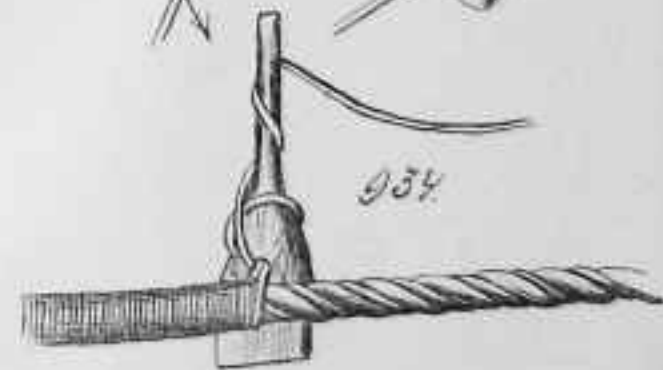

934



938



935

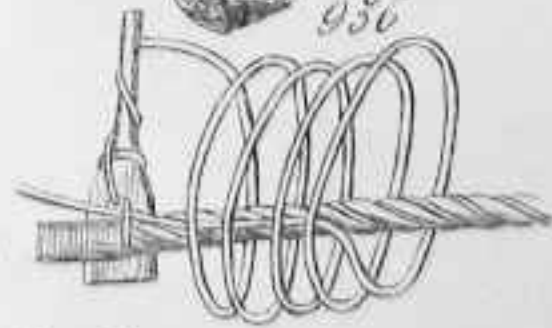

936

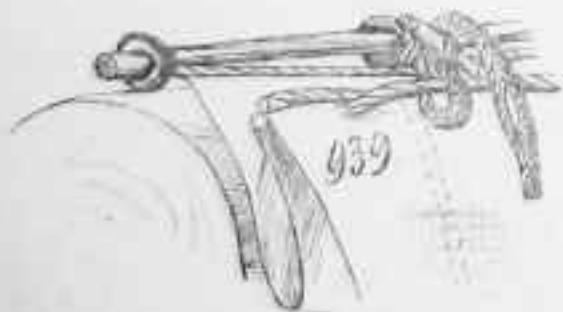

939

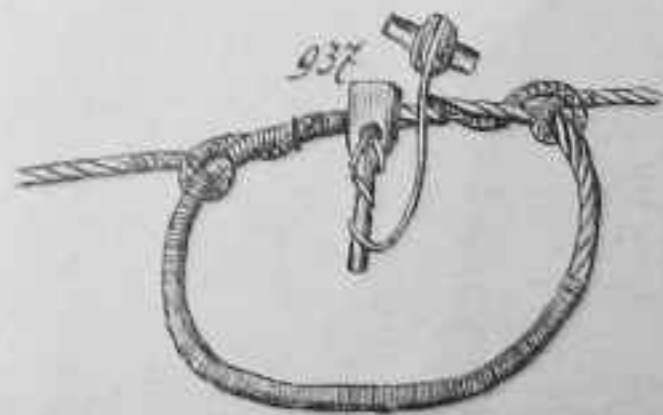

937

K. H. C. C. C.

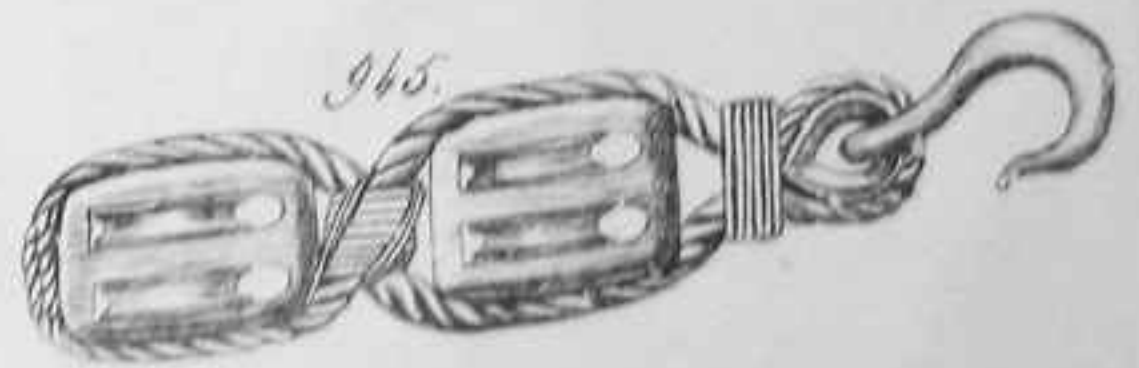
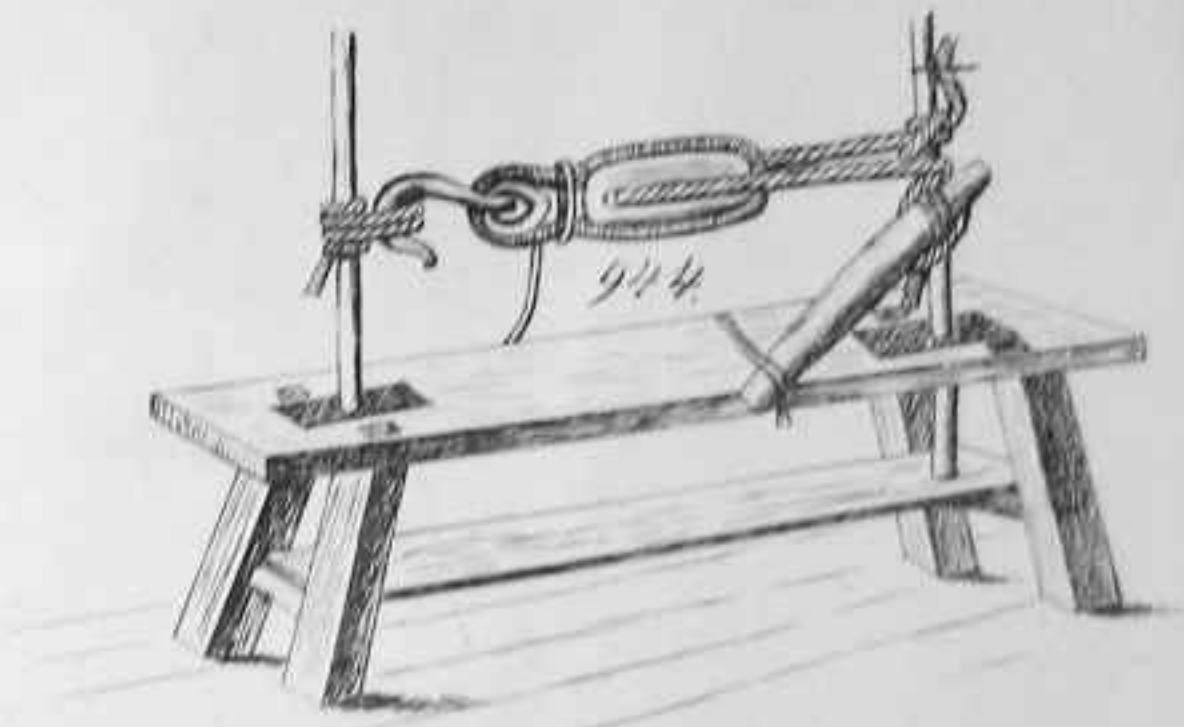
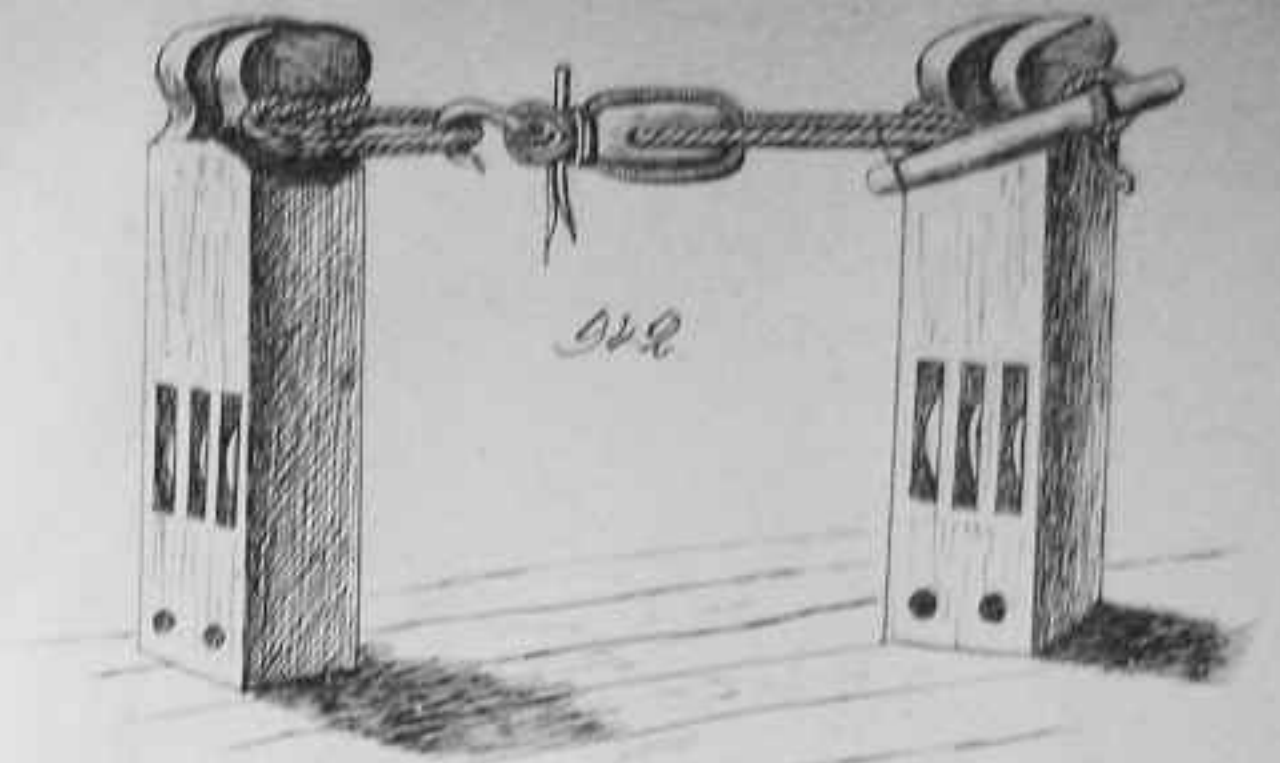
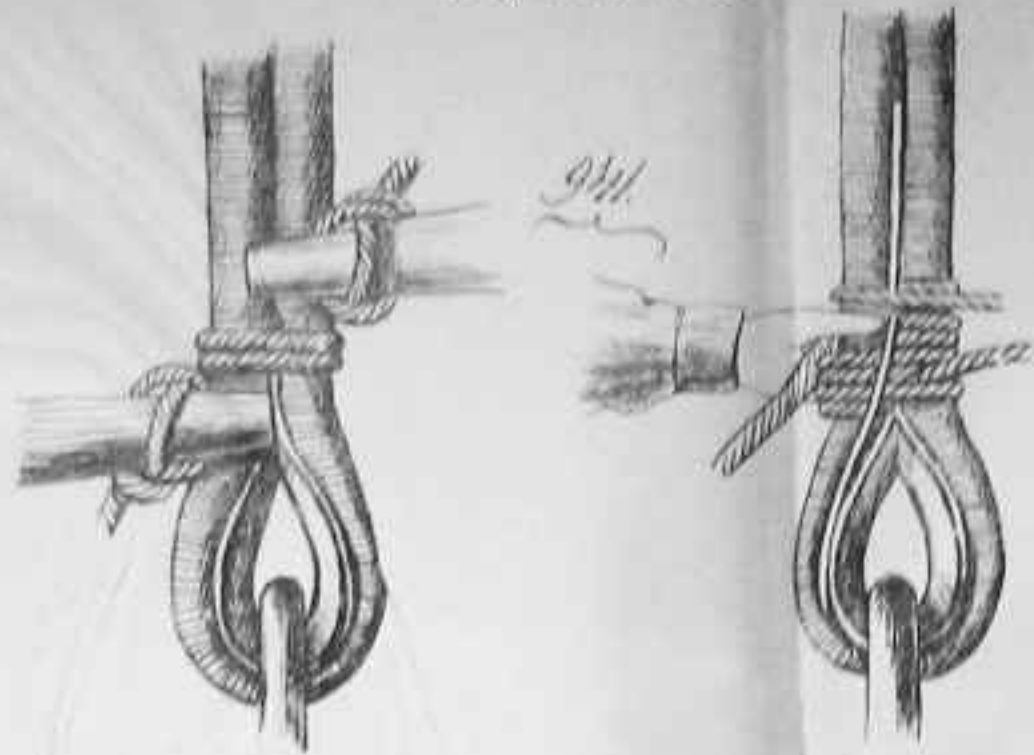
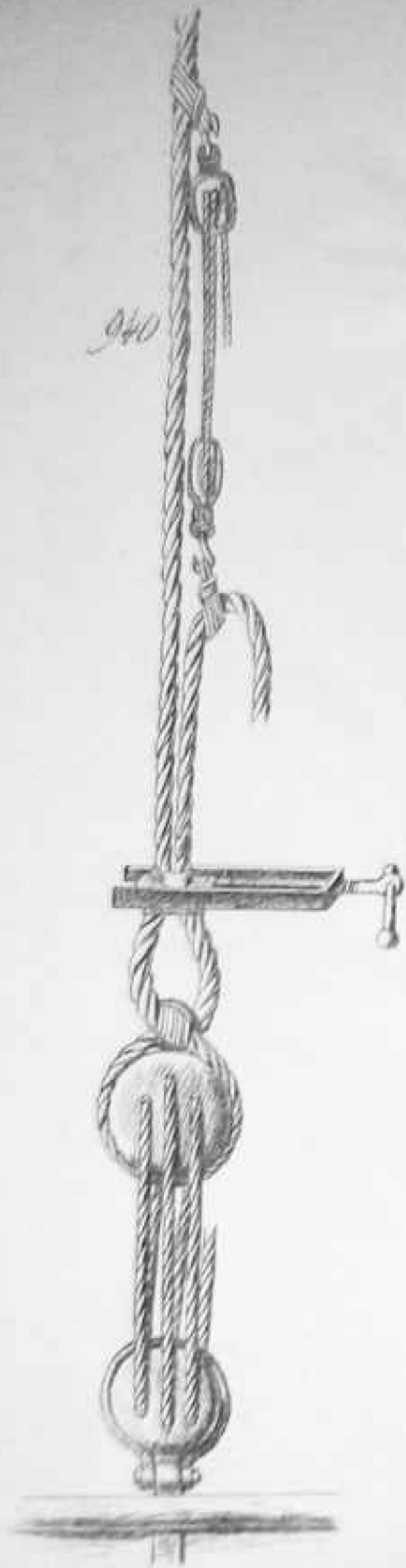

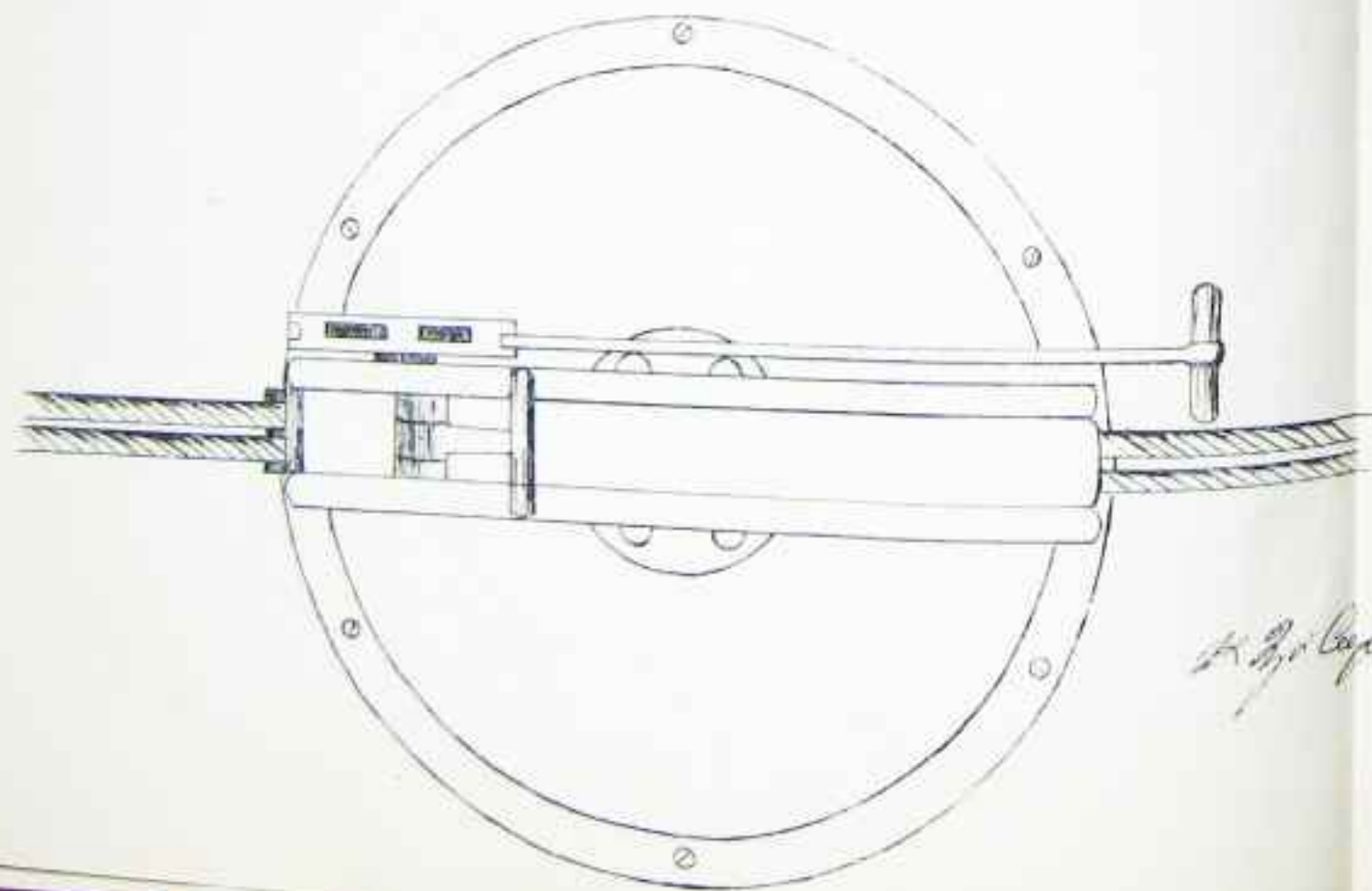
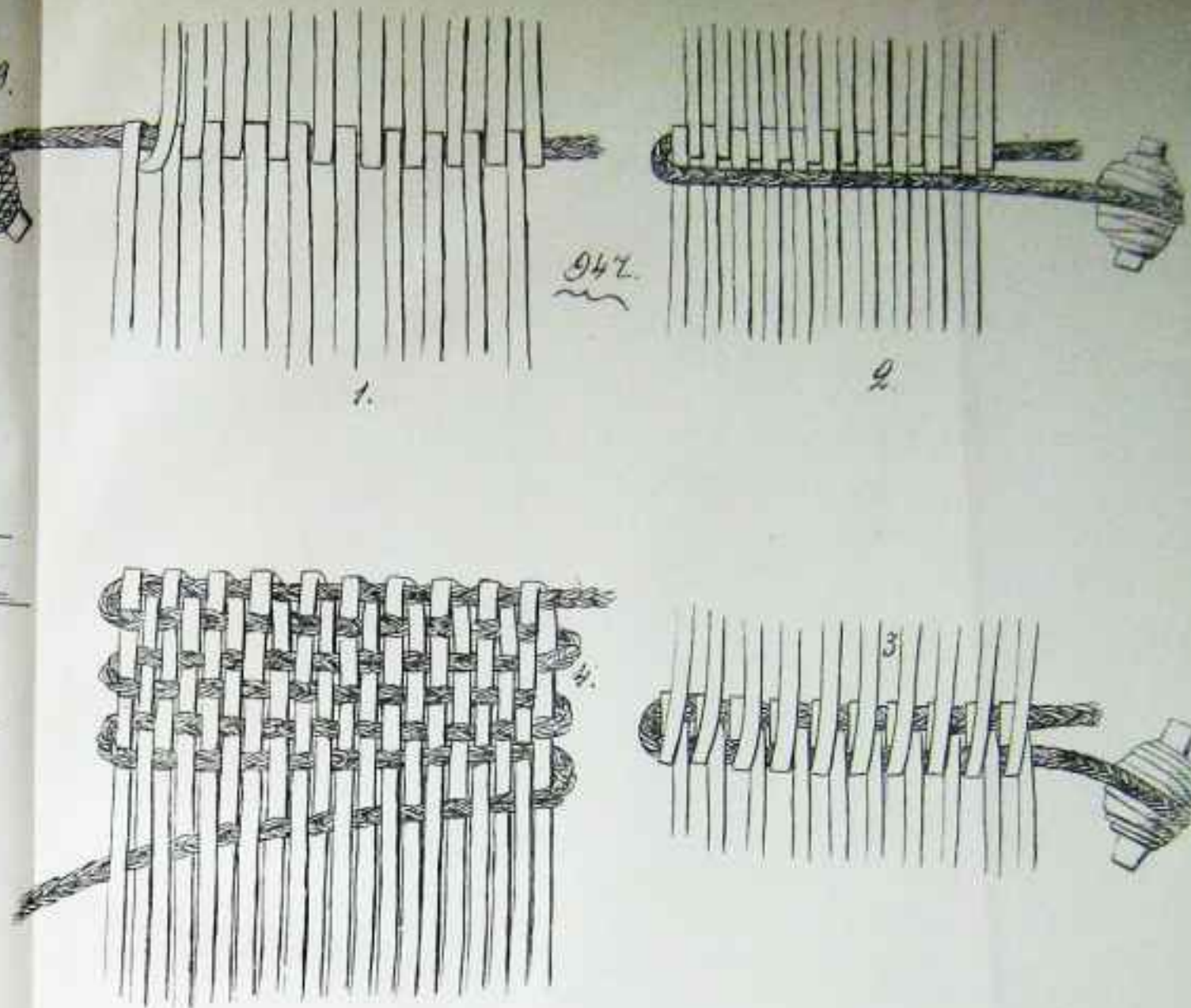
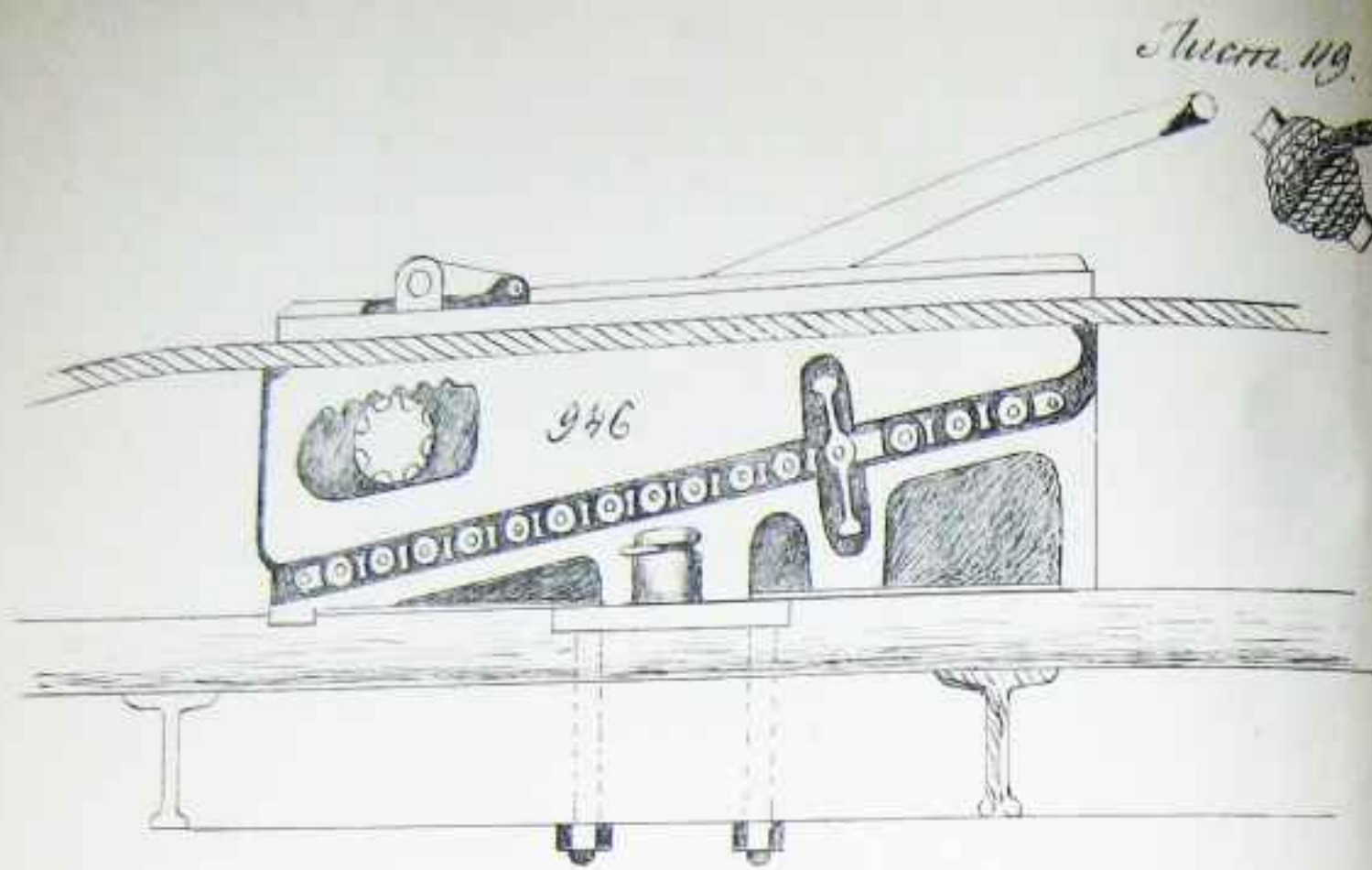

H. J. Caplan





Stucco 120



948

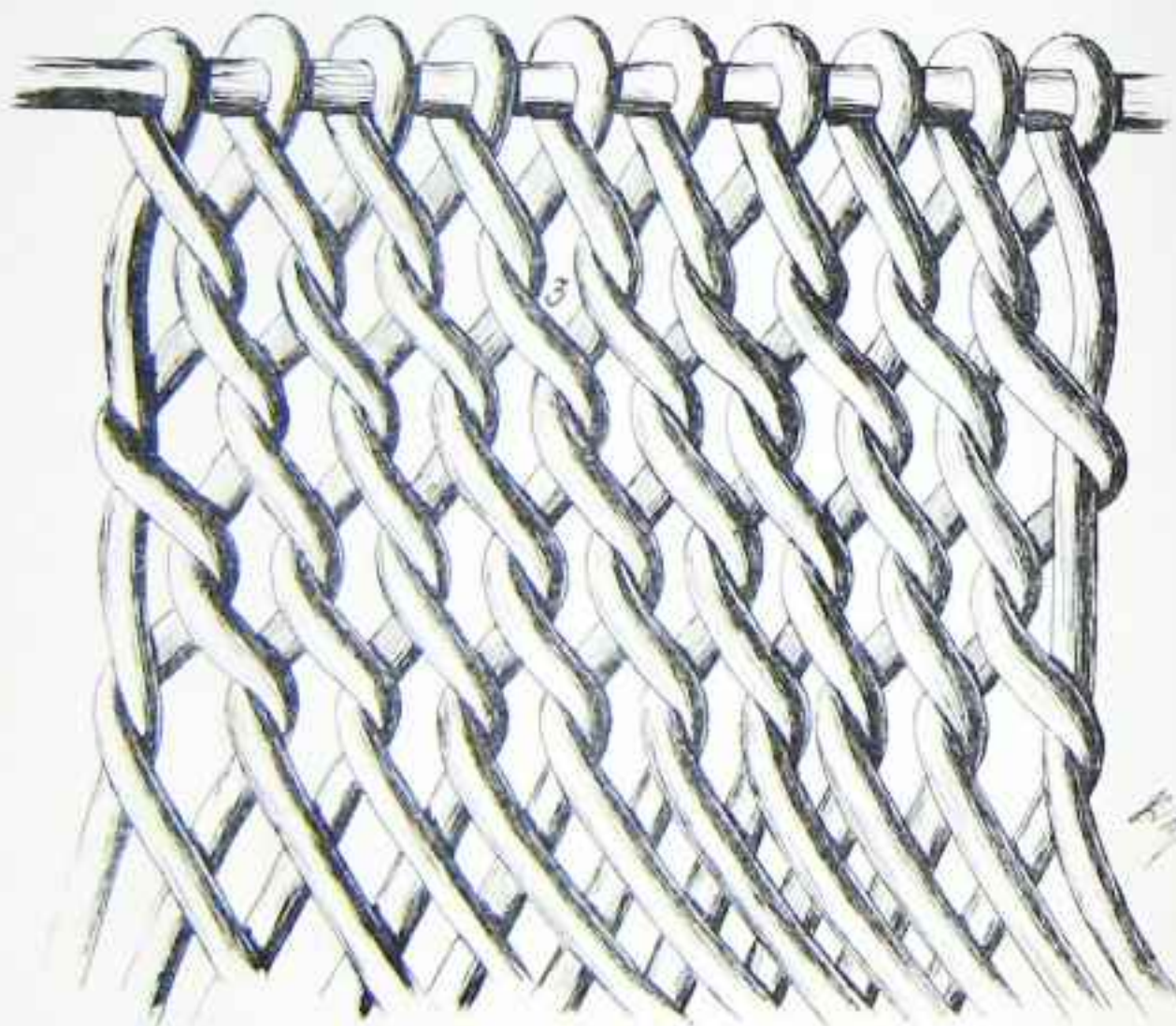

H. J. Rogers

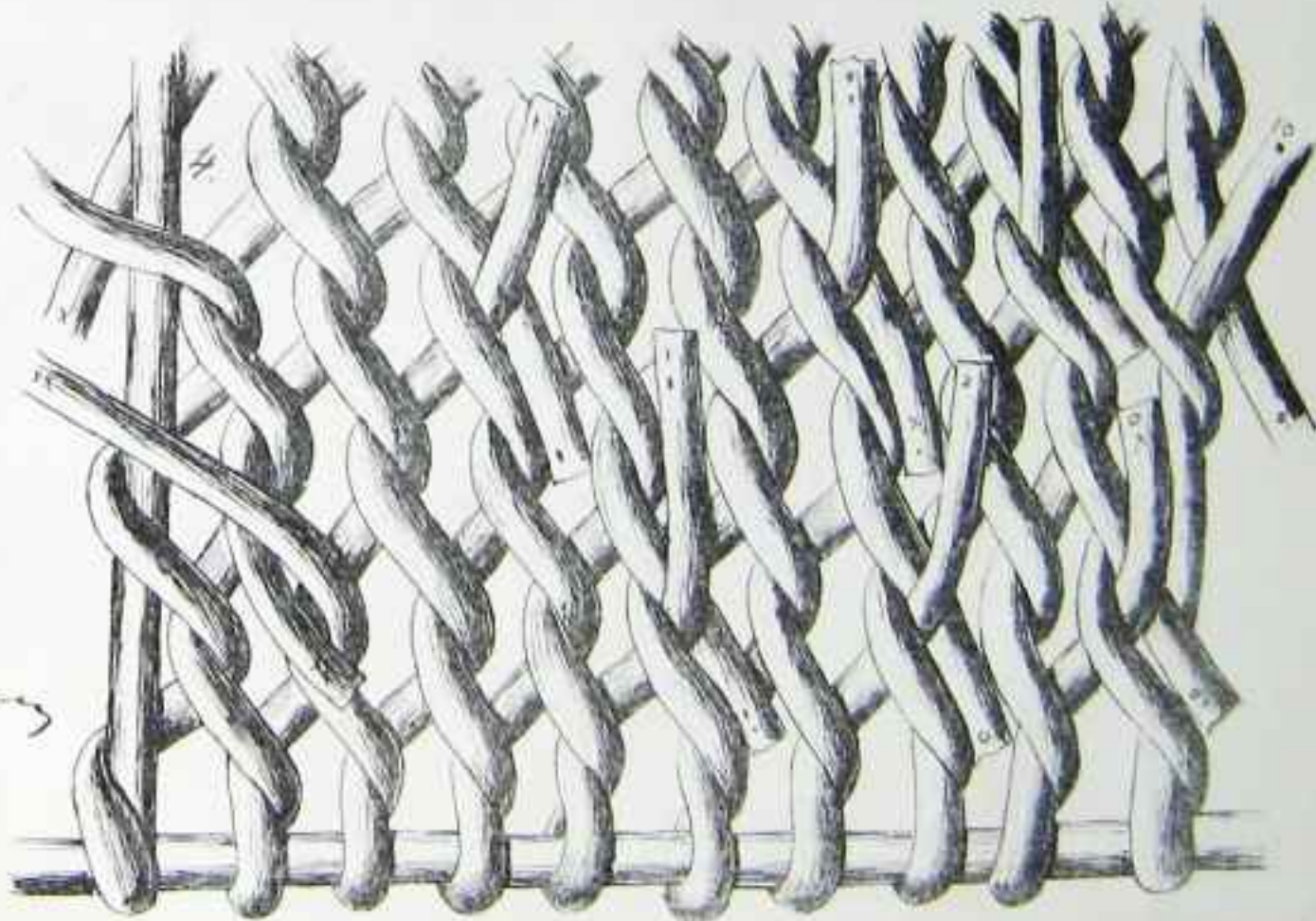

June 191

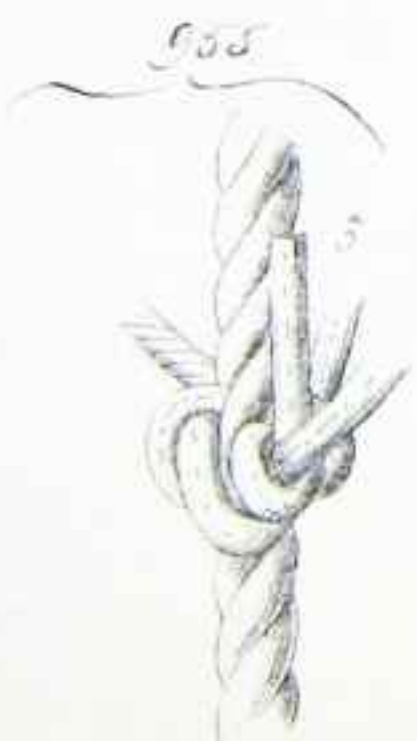
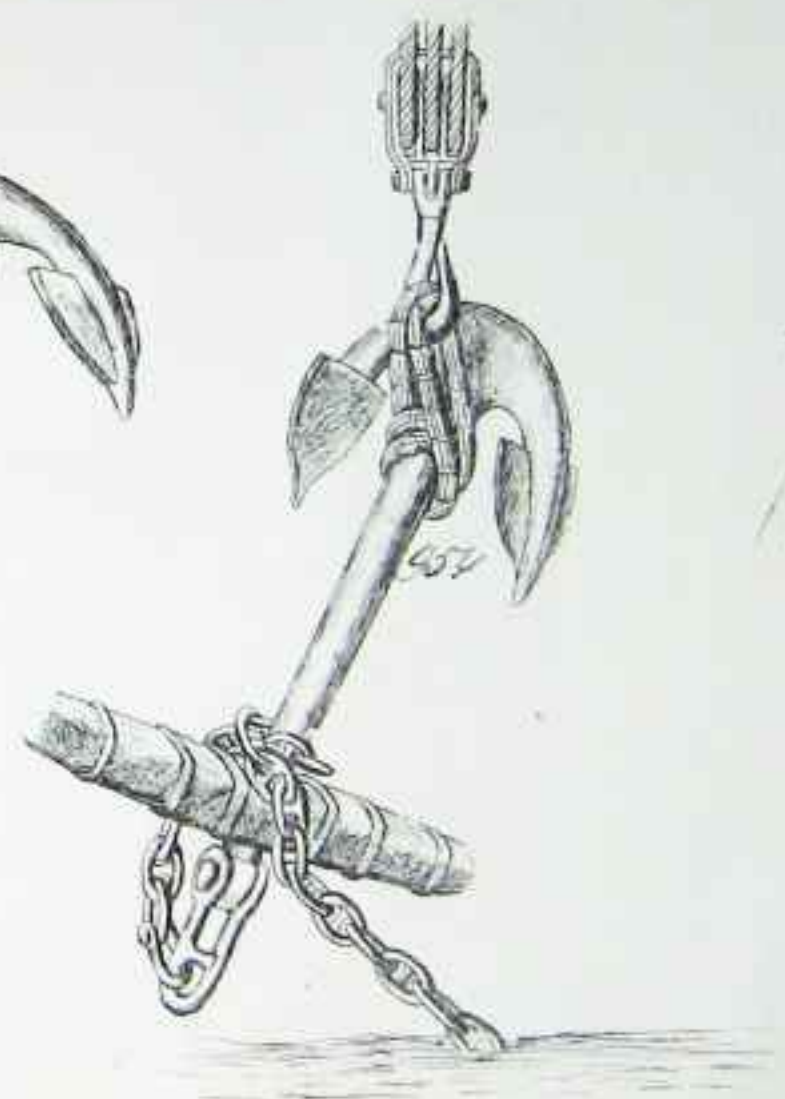
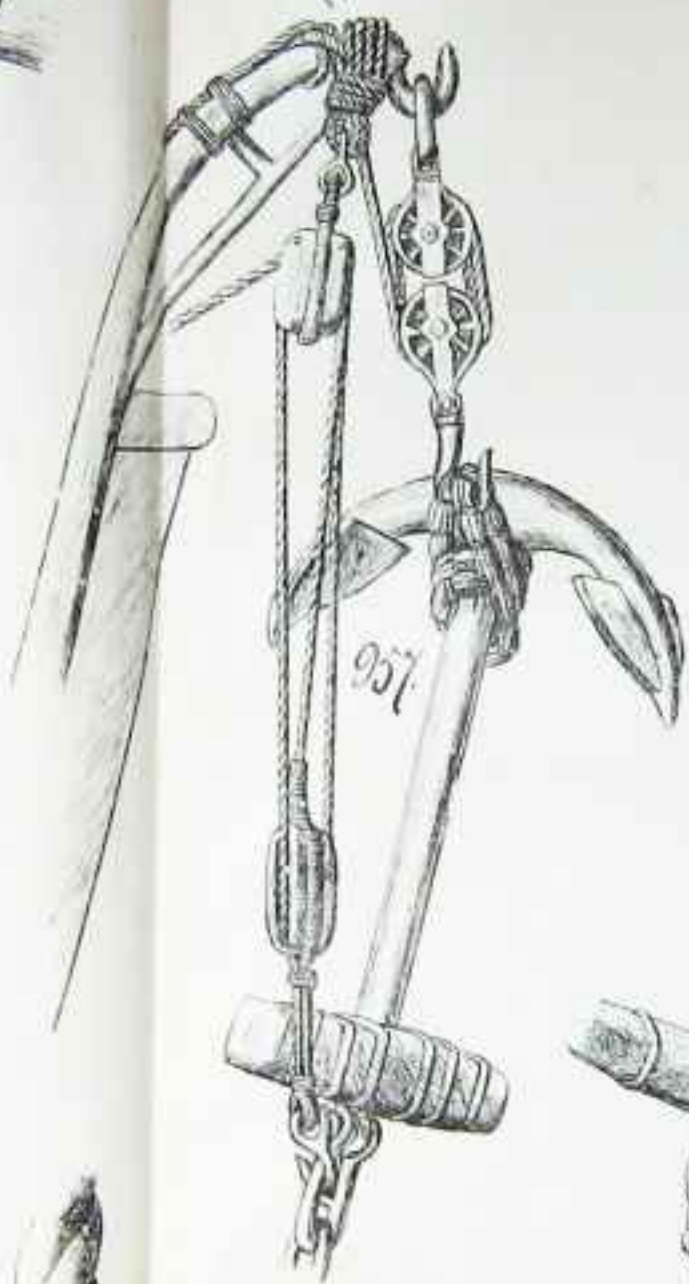
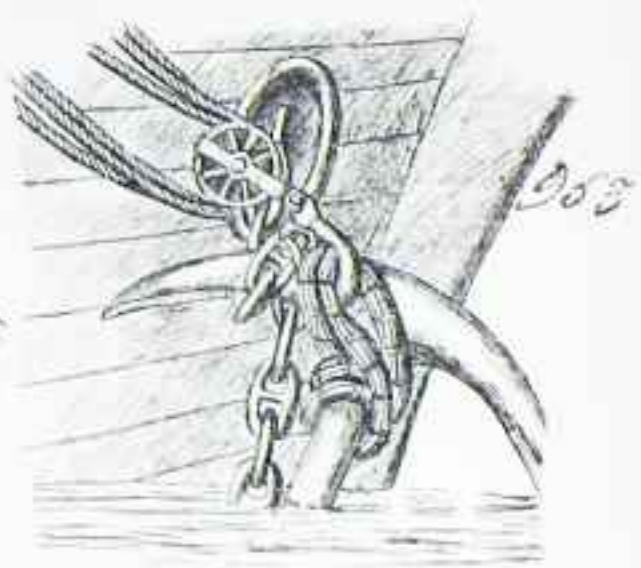
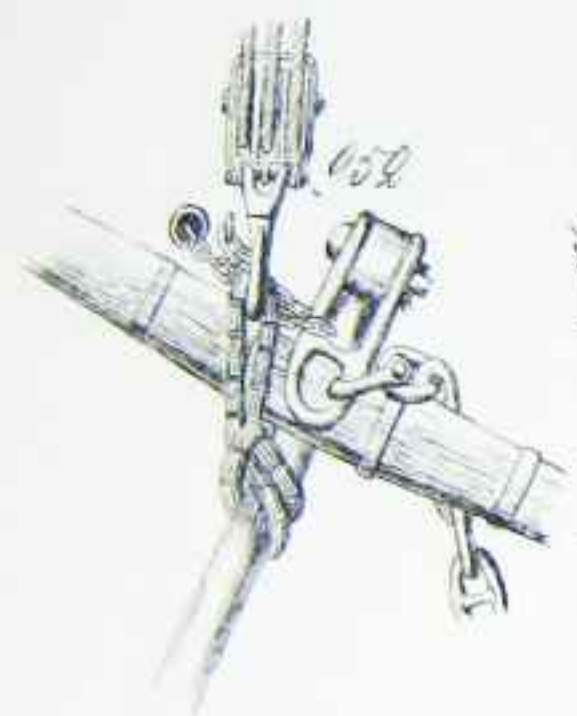
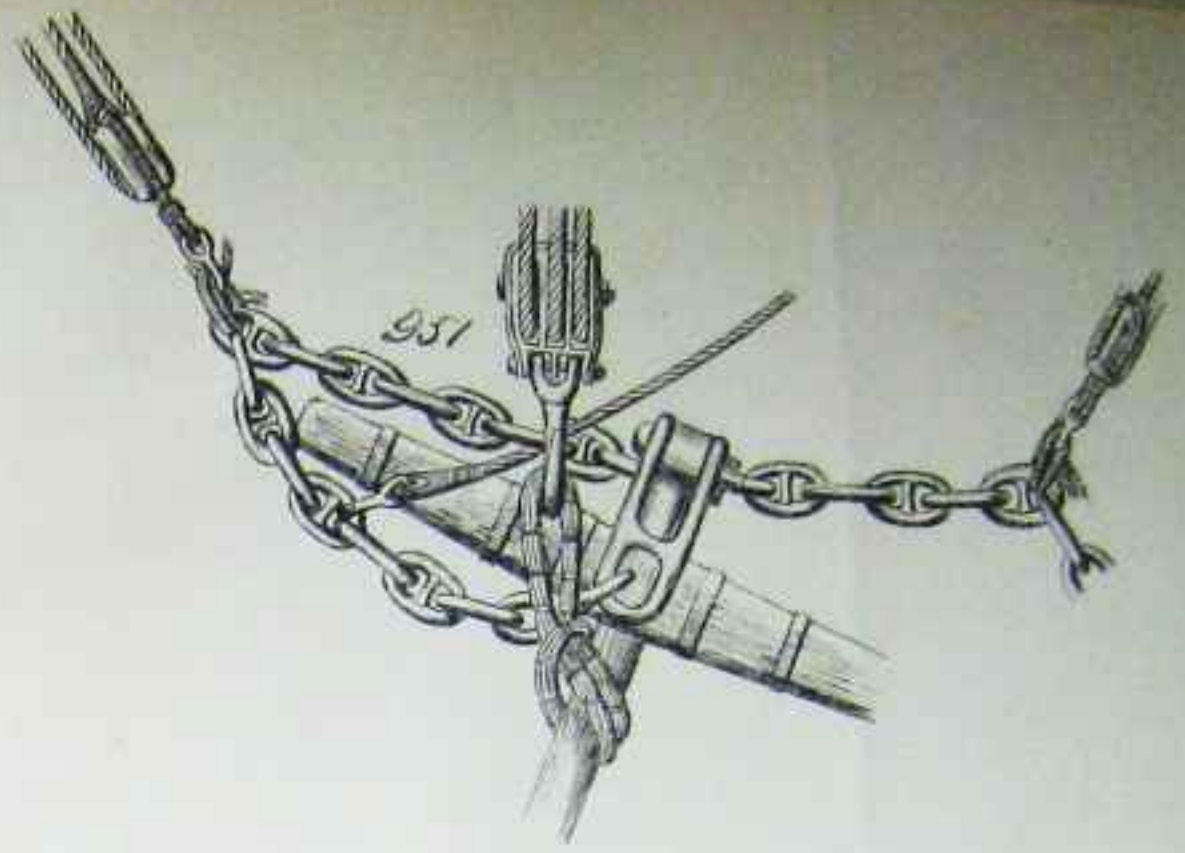
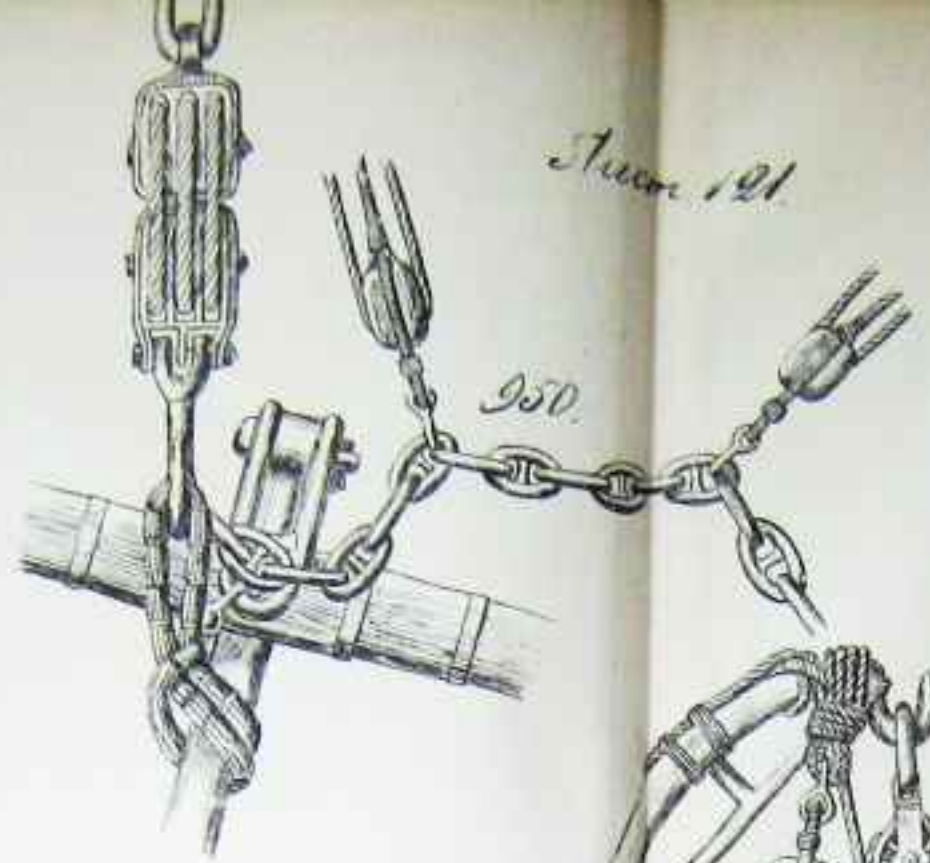
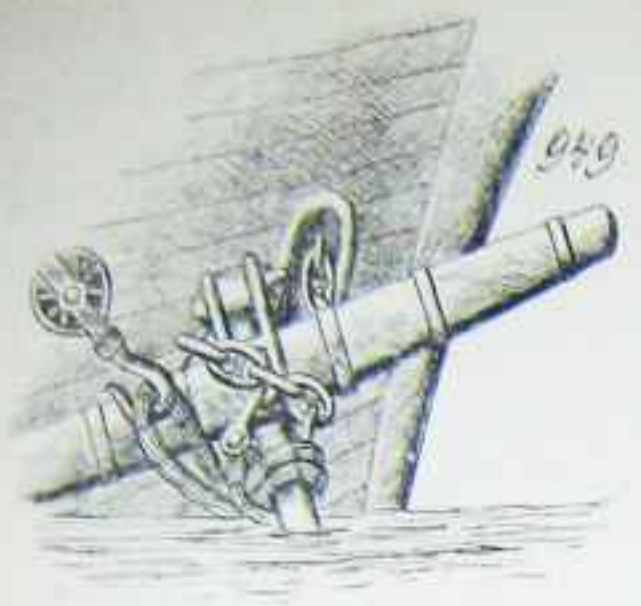

Handwritten signature or note at the bottom of the page.